

227/2/80

Personal Computer

SIMPLE
TV/VDU
CONVERSION

US \$2.00/FF8.80/LIRE 1700/DM 3.80/FL 4.00/BF 55 S Fr 3.50/Pts 135
DKr 10.75/SKr 7.65/NKr 8.25/A Sch 28

World MARCH 1980 50p

EUROPE'S

LEADING MICRO MAGAZINE

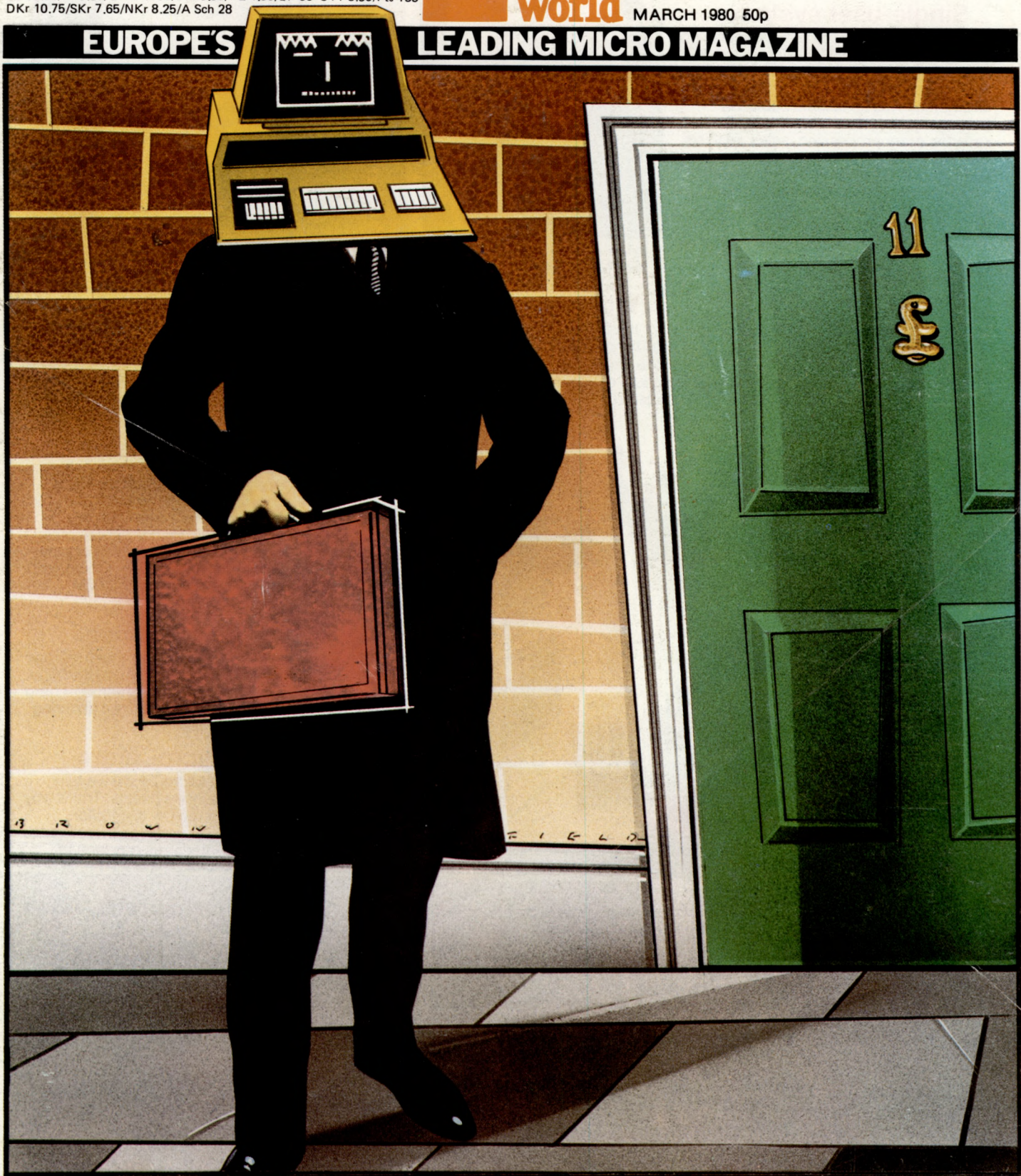

A CHANCELLOR WITH MACRONOIA?
Pit your wits against Britain's sagging economy

The computer with growth potential

The System Three is Cromemco's best selling small business computer. It's easy to see why.

Not only is it ideal for the first time computer user. But perhaps more important, it can be expanded into a comprehensive business facility servicing many varied company requirements.

Single-user system

You can start small. A 64K computer with a megabyte of floppy disc storage costs under £4,000.*

Perhaps your initial reason for choosing Cromemco was its flexible database management system—ideal for client records, order processing, sales analysis, inventory control, and many more business uses; or you might have required the full screen word processing system, capable of printing up to 20 original letters an hour; possibly you needed Cobol, Basic or Fortran, to develop your own customised packages.

Easy to use

Whatever the reason, you were highly impressed with the ease with which your very first computer application got off the ground. So you added another. And another. And pretty soon quite a lot of company business was running on your Cromemco.



Single-user System Three, with 64K memory, 2 discs, terminal and printer. Ideal for small businesses.

Will it expand?

It was then you discovered that the terminal is the limiting factor, because of the time taken to input data. If only you could connect a second terminal you could double your system's workload. . .

Multi-user system

Fortunately, we can readily expand your Cromemco. Unlike other makers' systems, all we need to do is add some memory and a ® TU-ART interface, and the multi-user system is ready to run . . . with a printer and up to 7 terminals, each with up to 48K.

New operating system

Moreover, your terminals can function quite independently of each other. Under Cromemco's new operating system they can be used to update and interrogate the company's database; for correspondence, with the word processing system; for data entry, using the full screen editor; or indeed for running any combination of CP/M software, **simultaneously**.

Up to 72 megabytes

We can increase your floppy disc storage to 2 megabytes if necessary. And if that's not enough, we can also add Cromemco's hard discs to provide you with up to an amazing **72 megabytes** on-line.

Rely on MicroCentre

Remember—at MicroCentre we fully understand Cromemco systems. That's why we're Cromemco's top UK distributors. So trust your initial Cromemco investment to MicroCentre. And call us any time to discuss your hardware enhancements or software needs.

Your company's future growth may depend on it.



Multi-user System Three, with 320K memory, 4 discs, 7 terminals and fast line printer. Each terminal has its own operating system, and can run any software package independently.

*Price excludes VAT and delivery. Terminals and printers to be added according to user requirements. ® TU-ART is a Cromemco trademark.

For  **Cromemco... call the experts**

NOW IN SPACIOUS
NEW SHOWROOMS

Tel. 031-556 7354

Micro Centre

STILL IN
CENTRAL EDINBURGH

Complete Micro Systems Ltd., 30 Dundas Street, Edinburgh EH3 6JN

CONTENTS

Volume 3 No. 3 March 1980

32 NEWSPRINT As always, PCW is first with the in-depth micro news.

40 COMMUNICATION A cross section of the reader's letters for this month.

42 BENCHTEST Sue Eisenbach reports on the Panasonic JD-700U

46 VIVA LAS VEGAS! Latest news on the American product front. Julian Allason visits the Consumer Electronics Fair and the backyards of Palo Alto.

51 WHISTLING UP COLOUR R.W. Lawrence gives sinusoidal instructions for Apple/ITT "hands off" control.

54 COMPUTER ANSWERS This month Sheridan Williams and friends concentrate on the "buying" aspect.

56 SYSTEMS Mike Knight turns his attention to Payroll packages.

59 MA CRONOIA Being Chancellor is fun! Battle with Britain's economy the Graham Addis way.

65 INTERRUPT Word on the "tail wags dog" revolution.

68 THE COMPLETE PASCAL Sadler and Eisenbach outline procedures and functions.

74 CHECKOUT Stephen Withers appraises the Symetec Apple II Light Pen.

76 PROGRAMMING — THE SIMPLE APPROACH An easy starter to the noble art — by Mervyn J. Axon

82 ON THE LINE David Hebditch closes down communications and talks about the future.

85 COMPUTER GAMES Big trees and the Alpha-Beta algorithm. David Levy continues the series.

88 BOOKFARE The death of the technical fix theory? Malcolm Peltu reports the ideas of Joseph Wizenbaum.

90 SIMPLE TV/MONITOR CONVERSION Peter Dunkley offers his low cost VDU alternative.

93 CALCULATOR CORNER Writing routines — a lesson in economy.

94 THE MEMORY LINGERS ON — PART 2 John Stephenson again — this time with a selective PROM copier.

95 DIRECT ACCESS — IN STORE (new look and vastly updated), **USER GROUP INDEX, DIARY DATA, TRANSACTION FILE** (sorry, no FAX this month).

103 PROGRAMS PCW's now famous listings section.

109 LEISURE LINES An "Irish" crossword and a multi-coloured cube. . . both under the influence of J. J. Clessa.

YOUNG COMPUTER WORLD — cancelled due to illness: **BACK SOON!**



Cover Illustration
Mick Brownfield

Founder
Angelo Zgorelec

Editor
Bruce Sawford

Technical Editor
David Tebbutt

Consultants
John Coll, Mike Dennis, Michael James, David Hebditch, Sheridan Williams, Dr. Adrian Stokes, Dr. Stephen Castell.

Advertising Manager
Stephen England
(01-631 1786)

Micromart
Jacquie Hancock
(01-631 1682)

Group Advertising Director
Richard Howell (01-631 3187)

Production Manager
Dick Pountain

Art Director
Paul Carpenter

Art Assistants
Jimmy Egerton, Julia Davies

Typesetter
Jane Hammell

Published by Sportscene Publishers (PCW) Ltd., 14 Rathbone Place, London

W1P 1DE, England. Tel: 01-637 7991/2/3. Telex: 8954139 A/B 'Bunch' G. London.

Copyright notice
Personal Computer World is published by Sportscene Publishers (PCW) Ltd. © 1980 Felden Productions. No material may be reproduced in whole or part without written consent from the copyright holders.

Printed by Riverside Press, Whitstable.

Distributed by Seymour Press Ltd., 334 Brixton Road, London SW9 7AG.

PCW welcomes all unsolicited material (written, photographic and illustrative) and although no guarantee can be given as to its safe return, reasonable care and attention will be exercised.

Guidelines for contributors
PCW welcomes articles of interest. Don't be put off if your style of writing is 'under developed'. . . true worth lies in the content, and shaping features comes naturally to us! Manuscripts should not exceed 3,000 words and authors as asked to use triple-spaced lines with a wide left-hand margin; diagrams, listings and/or photographs should be included wherever possible. Please enclose a stamped, self-addressed envelope if you would like your article returned.

Because of the foregoing, it is necessary to add that the views expressed in articles we publish are not necessarily those of Personal Computer World. Overall, however, the magazine will try to represent a balanced viewpoint.

Finally, before submitting an article, please check it through thoroughly for legibility and accuracy.

Subscription rates: Britain £8.00 for 12 issues, USA £22 for 12 issues (air mail), Continent £13, elsewhere £25 (airmail) for 12 issues. All prices include postage and packing. Supplies to specialist shops can be arranged by negotiation direct with the publishers.

Submitting programs to PCW

In order to keep our "Programs" section both full and interesting, we rely heavily on you, the readers, sending in useful and/or original contributions. **PLEASE DON'T STOP!** However, to make life easier for both you and us, it's worth our repeating the guidelines published last month.

Having written and thoroughly tested your original program (be it an application, a game, or a useful subroutine) send it to us, along with a suitable explanation. In order of preference we would like your program submitted as a clear, dark listing on plain paper. . . on cassette. . . or on disc. Please ensure that any typing or

handwriting is clear and that it has been checked for accuracy.

We pay the sender of any listing published — at least £10 and often much more — depending on the size and quality of the contribution. If the program is too large or complex for the "Programs" section we will sometimes publish it as a feature in the

magazine.

It seems that PET users are in the majority. . . we get more of their programs than any others. For the sake of balance, how about the "others" pitching in as well? Post your submissions to PCW Programs, 14 Rathbone Place, London W1P 1DE. We look forward to hearing from you.

DATRON of SHEFFIELD



£655 plus VAT
Excl. TV & Cassette

TEXAS

Home Computer TI-99/4.

See it in operation
and buy it at DATRON

Demonstrations.
9am - 5pm Monday - Saturday.

Call anytime - no obligation -
or by mail order.

HP/Leasing Available

BOOKS from DATRON

all books in stock at press date

Delivery free anywhere in the U.K.

The BASIC Handbook	David Lien	£11.50	PET Work Books Vol. 1-6	£19.00
Illustrating BASIC	Donald Alcock	£2.50	The Mighty Micro	Dr C. Evans
Basic BASIC	Donald M. Munro	£2.00	Intro. to Personal & Business Computing	Zaks
The Little Book of BASIC Style	Nevison	£5.25	Micro Appl. in Business & Industry	Whitbread
Some Common Basic Programs	Osborne	£6.45	Peanut Butter & Jelly Guide to Micros	Willis
Some Common Basic Programs (PET cassette)		£7.95	Running Wild	Osborne
32 BASIC Programs for the PET	Rugg & Feldman	£9.75	A Career in Computing	Penney
BASIC Primer	Waite & Pardee	£6.95	Philips Guide to Bus. Computers & the	Enticknap
A guide to BASIC Programming	Spencer	£8.85	Electronic Office	£3.50
A guide to PL/M Programming	McCracken	£7.95		
			Basic Computer Games	Creative Computing
PASCAL An Intro. to Methodical Prog.	Findlay & Watt	£4.95	More Basic Computer Games	Creative Computing
Introduction to PASCAL	Welsh & Eider	£5.95	Game Playing with Computers	Spencer
Programming in PASCAL	Grogono	£6.75	Game Playing with BASIC	Spencer
Primer on PASCAL	Conway et al	£7.10		
Struct. Prog. & Problem Solving with			How to Build a Computer Controlled Robot	Loofbourrow
PASCAL	Kieburz	£8.40	How to Profit from your Personal Computer	T. G. Lewis
Micro Problem Solving - PASCAL	Bowles	£6.95		
			TTL Cookbook	Lancaster
COBOL for Business Applications	Philippakis	£10.25	CMOS Cookbook	Lancaster
COBOL with Style	Chmura & Ledgard	£5.40	TV Typewriter Cookbook	Lancaster
Learning COBOL Fast	de Rossi	£6.45	Cheap Video Cookbook	Lancaster
				£4.95
FORTAN Techniques	A. Colin Day	£2.25	Best of Byte	£8.45
FORTAN Fundamentals	J. Staingraber	£3.45	Best of Creative Computing Vol. 1	£6.95
Problem Solving & Struct. Prog. in FORTAN	Friedman & Koffman	£9.95	Best of Creative Computing Vol. 2	£6.95
	Donald M. Munro	£3.95		
Computing with FORTAN				
An Intro. to Prog. & Applications with	Hull & Day	£8.45		
FORTAN				
Z80 Micro Handbook	W. Barden	£6.95		
Z80 Programming for Logic Design	Osborne	£6.30		
Z80 Micro. Prog. & Interfacing Bk. 1	Nichols & Rony	£7.75		
Z80 Micro. Prog. & Interfacing Bk. 2	Nichols & Rony	£8.50		
Z80 Instant Programs	J. Hopton	£7.50		
Z80 Programs (cassette)		£10.00		
Z80 Assembly language Prog.	Leventhal	£6.95		
6502 Assembly language Prog.	Leventhal	£6.95		
6502 Applications Book	Sybex	£8.95		
Programming the 6502	Zaks	£7.95		
Programming a Micro (6502)	Foster	£7.25		

P&P free U.K.

Overseas add £1 any order size

Phone in your Access
Barclaycard No
0742 585490
or complete this
order form

Send s.a.e. for full list. Prices correct at
going to press. Add 12p insurance on
books if required.

Cromenco IT 2020 appli! PET
TEXAS INSTRUMENTS **na/com-1**

Please supply

I enclose - £
Cheque/Postal Order No.
Barclaycard/Access No.
Name:
Address:

Datron Micro Centre, Latham House, 243 London Road,
Sheffield S2 4NF. Tel: 0742-585490



nm

Nascom Microcomputers

No 1 & 2 for choice!

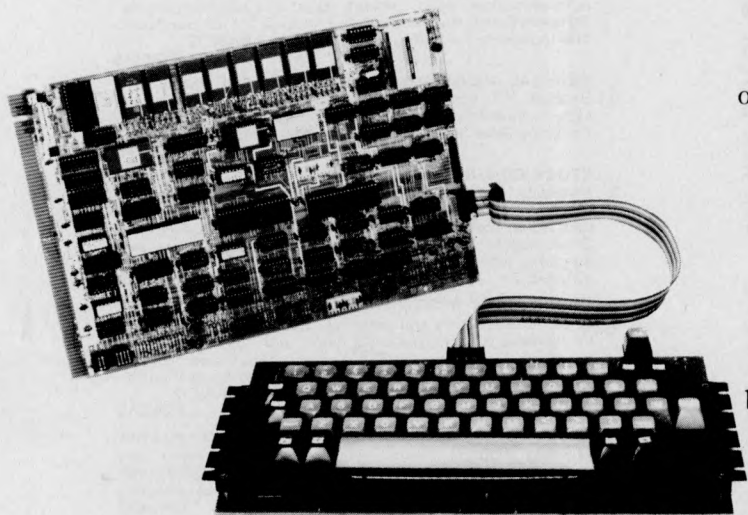

NASCOM - 1 or 2. This ever popular all British microcomputer which comes factory fresh as supplied by the manufacturer. A whole range of options and expansions both hardware and software are available now.

Price: NASCOM-1 £125 (kit)
£140 (assembled)

NASCOM-2 £295 (kit)
£330 (assembled)

DC 80 - 1 or 2. This new desktop version of Nascom is intended to help the hobbyist or professional. Fully assembled with power supply basic and desktop case suitable for both Nascom - 1 and 2 versions, this adds a new dimension to this

British micro.
Price: DC 80 - 1 £295.00
DC 80 - 2 £460.00
Case Only £35.00



BCC 80 - 1 or 2. For the traveller or user who requires a mobile computer, this portable computer is available with Nascom - 1 or 2. It comes with a variety of options including an acoustic coupler for remote communication via a telephone handset.

Price: BCC 80 - 1 £405.00
BCC 80 - 2 £535.00
Case Only £85.00

All prices are subject to change without notice and are exclusive of VAT at the current rate

PML offer a full range of Nascom equipment, ask for our price list and similar versions of the Rockwell AIM 65

P.S. We will shortly be offering a NASBUS to S100 expansion and conversion motherboard which will fit inside the DC 80 case



**Portable
Microsystems
Limited**

Forby House, 18 Market Place,
Brackley,
Northants NN13 5SF
Telephone Brackley (0280) 702017
Telex Micro 83147

Shopping List

Super software from the world's leading microsoftware supplier.

- | | Software
with
Manual | Manual
/
Alone | | Software
with
Manual | Manual
/
Alone |
|---------------------------------------|---|----------------------|--|----------------------------|----------------------|
| DIGITAL RESEARCH | | | | | |
| (M) | CP/M* FDOS — Diskette Operating System complete with Text Editor, Assembler, Debugger, File Manager and system utilities. Available for wide variety of disk system including North Star, Helios II, Micropolis, ICOM (all systems) and Altair. Supports computers such as Sorcerer, Horizon, Cromemco, Ohio Scientific, RAIR Black Box, Research Machines, Dynadybe, etc. | £75/£15 | | | |
| | CP/M version 2 (not all formats available immediately) | £95/£15 | | | |
| | MP/M | £195/£25 | | | |
| | MAC — 8080 Macro Assembler. Full Intel macro definitions. Pseudo Ops include RPC, IRP, REPT, TITLE, PAGE, and MACLIB. Z-80 library included. Produces Intel absolute hex output plus symbols file for use by SID (see below) | £55/£10 | | | |
| | SID — 8080 symbolic debugger. Full trace, pass count and break-point program testing system with back-trace and histogram utilities. When used with MAC, provides full symbolic display of memory labels and equated values | £45/£10 | | | |
| | ZSID Includes Z80 mnemonics and macros for Z80 CPU | £50/£10 | | | |
| | TEX — Text formatter to create paginated, page-numbered and justified copy from source text files, directable to disk or printer | £45/£10 | | | |
| | DESPOOL — Program to permit simultaneous printing of data from disk while user executes another program from the console | £30/£1 | | | |
| MICROSOFT | | | | | |
| (L) | BASIC-80 — Disk Extended BASIC Interpreter Version 5, ANSI compatible with long variable names, WHILE/WEND, chaining, variable length file records | £155/£15 | | | |
| (L) | BASIC Compiler — Language compatible with Version 5 Microsoft interpreter and 3-10 times faster execution. Produces standard Microsoft relocatable binary output. Includes Macro-80. Also linkable to FORTRAN-80 or COBOL-80 code modules | £195/£15 | | | |
| (L) | FORTRAN-80 — ANSI '66 (except for COMPLEX) plus many extensions. Includes relocatable object compiler, linking loader, library with manager. Also includes MACRO-80 (see below) | £205/£15 | | | |
| (L) | COBOL-80 — ANSI '74 Relocatable object output. Format same as FORTRAN-80 and MACRO-80 modules. Complete ISAM. Interactive ACCEPT DISPLAY, COPY, EXTEND | £325/£15 | | | |
| (L) | MACRO-80 — 8080/Z80 Macro Assembler. Intel and Zilog mnemonics supported. Relocatable linkable output. Loader, Library Manager and Cross Reference List utilities included | £75/£10 | | | |
| (L) | XMACRO-86 — 8086 cross assembler. All Macro and utility features of MACRO-80 preserved. Mnemonics slightly modified from Intel ASM86. Compatibility data sheet available | £155/£15 | | | |
| (L) | EDIT-80 — Very fast random access text editor for text with or without line numbers. Global and intra-line commands supported. File compare utility included | £45/£10 | | | |
| EIDOS SYSTEMS | | | | | |
| (L) | KISS — Keyed Index Sequential Search. Offers complete Multi-Keyed Index Sequential and Direct Access file management. Includes built-in utility functions for 16 or 32 bit arithmetic, string/integer conversion and string compare. Delivered as a relocatable linkable module in Microsoft format for use with FORTRAN-80 or COBOL-80 etc | £190/£15 | | | |
| (L) | KBASIC — Microsoft Disk Extended BASIC with all KISS facilities, integrated by implementation of nine additional commands in language. Package includes KISS REL as described above, and a sample mail list program | £295/£25 | | | |
| | To licensed users of Microsoft BASIC-80 (M BASIC) | £215/£25 | | | |
| MICROPRO | | | | | |
| (L) | Super-Sort 1 — Sort, merge, extract utility as absolute executable program or linkable module in Microsoft format. Sorts fixed or variable records with data in binary, BCD, Packed Decimal, EBCDIC, ASCII, floating, fixed point, exponential, field justified, etc. etc. Even variable number of fields per record! | £125/£15 | | | |
| (L) | Super-Sort II — Above available as absolute program only | £105/£15 | | | |
| (L) | Super-Sort III — As II without SELECT/EXCLUDE | £75/£15 | | | |
| (L) | Word-Master Text Editor — In one mode has super-set of CP/M's ED commands including global searching and replacing, forward and backwards in file. In video-mode, provides full screen editor for users with serial addressable-cursor terminal | £75/£15 | | | |
| (L) | Word-Star — Menu driven visual word processing system for use with standard terminals. Text formatting performed on screen. Facilities for text pagination, page number, justify, center, underscore and PRINT. Edit facilities include global search and replace, read/write to other text files, block move, etc. Requires CRT terminal with addressable cursor positioning | £255/£15 | | | |
| GRAFFCOM | | | | | |
| (L) | PAYROLL — Designed in conjunction with the spec for PAYE routines by HMI Taxes. Processes up to 250 employees on weekly or monthly basis. Can handle cash, cheque or bank transfer payments plus total tracking of all year to date figures. Prints emp master, payroll log, payslips and bank giros. Requires CBASIC-2 | £475/£15 | | | |
| (L) | COMPANY SALES — Performs sales accounting function. Controls payments of invoices and prints sales ledger and aged debtors report. Suitable for any accounting period. Comprehensive VAT control and analysis of all sales invoices. Requires CBASIC-2 | £425/£15 | | | |
| (L) | COMPANY PURCHASES — Performs purchase accounting function. Controls invoices, credit & debit notes. Prints purchase ledger, aged creditors report and payment advices. Comprehensive VAT control and analysis of all purchases. Interfaces with the NAD system. Requires CBASIC-2 | £425/£15 | | | |
| (L) | GENERAL ACCOUNTING — Produces Nominal Ledger, Trial Balance, P/L and Balance Sheet. Define your own coding system. Interactive data entry plus optional data capture from Company Sales and Company Purchases. Requires CBASIC-2 | £375/£15 | | | |
| (L) | STOCK CONTROL — Maintains stock records, monitors stock levels to ensure optimum stock holding. Details include stock desc., product code, unit, unit price, quantity on hand on order/minimum. Stock analysis reports can be generated weekly, monthly, quarterly etc. Interfaces with Order Entry & Invoicing system. Requires CBASIC-2 | £325/£15 | | | |
| (L) | ORDER ENTRY & INVOICING — Performs order entry and invoicing function. Handles invoices for services and consumable items, part orders and part quantities. Sales Analysis report shows sales movements and trends for user-defined period. Interfaces with Stock Control, NAD and Company Sales systems. Requires CBASIC-2 | £325/£15 | | | |
| (L) | NAD — Complete control of all your names & addresses including suppliers, clients, enquiries etc. Assign your own coding system and select all output via the report generator. Will print anything from mailing labels to directories. Requires CBASIC-2 | £225/£12 | | | |
| (L) | COMPLETE ACCOUNTING PACKAGE — Combined Company Sales, Company Purchases, General Accounting, and NAD systems | £950/£45 | | | |
| (L) | SALES ORDER PROCESSING PACKAGE — Combined Stock Control, Order Entry and Invoicing and NAD systems | £550/£30 | | | |
| STRUCTURED SYSTEMS GROUP | | | | | |
| (L) | ANALYST — Customised data entry and reporting system. User specifies up to 75 data items per record. Interactive data entry, retrieval and update facility makes information management easy. Sophisticated report generator provides customised reports using selected records with multiple level breakpoints for summarisation. Requires CBASIC-2, 24 x 80 CRT, printer and 48K system | £125/£10 | | | |
| (L) | LETTERRIGHT — Program to create edit and type letters or other documents. Has facilities to print, display, delete and move text, with good video screen presentation. Designed to integrate with NAD for form letter mailings. Requires CBASIC-2 | £105/£15 | | | |
| (L) | NAD Name and Address selection system — interactive mail list creation and maintenance program with output as full reports with reference data or restricted information for mail labels. Transfer system for extraction and transfer of selected records to create new files. Requires CBASIC-2 | £45/£12 | | | |
| (L) | QSORT — Fast soft/merge program for files with fixed record length, variable field length information. Up to five ascending or descending keys. Full back-up of input files created. Parameter file created optionally with interactive program which requires CBASIC-2. Parameter file may be generated with CP/M assembler utility | £50/£12 | | | |
| SOFTWARE SYSTEMS | | | | | |
| (M) | CBASIC-2 Disk Extended BASIC — Non-interactive BASIC with pseudo-code compiler and runtime interpreter. Supports full file control, chaining, integer and extended precision variables etc. | £75/£10 | | | |
| GRAHAM-DORIAN SOFTWARE SYSTEMS | | | | | |
| (L) | APARTMENT MANAGEMENT SYSTEM — Financial management system for receipts and security deposits of apartment projects. Captures data on vacancies, revenues, etc. for annual trend analysis. Daily report shows late rents, vacancy notices, vacancies, income lost through vacancies, etc. Requires CBASIC-2. Supplied in source code. | £300/£25 | | | |
| (L) | INVENTORY SYSTEM — Captures stock levels, costs, sources, sales, ages, turnover, markup, etc. Transaction information may be entered for reporting by salesman, type of sale, date of sale, etc. Reports available both for accounting and decision making. Requires CBASIC-2. Supplied in source code | £300/£25 | | | |

Software for most popular 8080/Z80 computer disk systems including
**NORTH STAR HORIZON, VECTOR MZ, OHIO SCIENTIFIC,
 CROMEMCO, PROCESSOR TECHNOLOGY, RAIK BLACK BOX,
 DYNABYTE, SD SYSTEMS, RESEARCH MACHINES, ALTAIR,
 EXIDY SORCERER, IMSAI, HEATH, and 8" IBM formats**

Software with Manual
 with Manual Alone

Software with Manual
 with Manual Alone

- CASH REGISTER** — Maintains files on daily sales. Files data by sales person and item. Tracks sales. Overruns, refunds, payouts and total net deposits. Requires CBASIC. Supplied in source code £300/£25
- MICRO FOCUS**
- STANDARD CIS COBOL** — ANSI '74 COBOL standard compiler fully validated by U.S. Navy tests to ANSI level 1. Supports many features to level 2 including dynamic loading of COBOL modules and a full ISAM file facility. Also, program segmentation, interactive debug and powerful interactive extensions to support protected and unprotected CRT screen formatting from COBOL programs used with any dumb terminal £400/£25
- FORMS 2** — CRT screen editor. Automatically creates a query and update program of indexed files using CRT protected and unprotected screen formats. Input is COBOL data descriptions for copying into CIS C or JCL programs. No programming experience needed. Output program directly compiled by CIS COBOL (standard) £100/£12
- OTHER**
- PASCAL/Z** — Z80 native code PASCAL compiler. Produces optimised portable reentrant code. All interfacing to CP/M is through the support library. The package includes compiler companion macro assembler and source for the library. Requires 56K and Z80 CPU. Version 2 includes all of Jensen/Wirth except variant records £155/£15
- Version 3 Upgrade with variant records and strings expected 2/80 £205/£15
- PASCAL/MT** — Subset of standard PASCAL. Generates portable 8080 machine code. Symbolic debugger included. Supports interrupt procedure and BCD arithmetic for real variables. CP/M file I/O and assembly language interface supported. Lacks sets, Enumeration and Record data types. Manual explains BASIC to PASCAL conversion Requires 32K £65/£17
- Source for PASCAL/MT run time package. Requires MAC (See under Digital Research) £30
- tiny C** — interactive interpretive system for teaching structured programming techniques. Manual includes full source listings £45/£30
- BDS C COMPILER** — Supports most major features of language, including Structures, Arrays, Pointers, recursive function evaluation, linkable with library to 8080 binary output. Lacks data initialization, long & float type and static & register class specifiers. Documentation includes "C" Programming Language book by Kernighan & Ritchie £60/£10
- WHITESMITHS' C COMPILER** — The ultimate in systems software tools. Produces faster code than Pascal with more extensive facilities. Conforms to the full UNIX Version 7 C language, described by Kernighan and Ritchie, and makes available over 75 functions for performing I/O, string manipulation and storage allocation. Compiler output in A-Natural source. Supplied with A-Natural. Requires 60K CP/M £325/£20
- POLYVUE/80** — Full screen editor for any CRT with XY cursor positioning. Includes vertical and horizontal scrolling, interactive search and replace, automatic text wrap around for word processing, operations for manipulating blocks of text, and comprehensive 70 page manual £70/£12
- POLYTEXT/80** — Text formatter for word processing applications. Justifies and paginates source text files. Will generate form letters with custom fields and conditional processing. Support for dot matrix Wheel printers includes variable pitch justification and motion optimization. £45/£10
- ALGOL 60 Compiler** — Powerful block-structured language featuring economical run time dynamic allocation of memory. Very compact (24K total RAM) system implementing almost all Algol 60 report features plus many powerful extensions including string handling, direct disk address I/O etc. Requires Z80 CPU £110/£12
- Z80 Development Package** — Consists of (1) disk file line editor, with global inter and intra-line facilities; (2) Z80 relocating assembler, Zilog Mostek mnemonics, conditional assembly and cross reference table capabilities; (3) linking loader producing absolute Intel hex disk file for CP/M LOAD, DDT or SID facilities £50/£12
- ZDT** — Z80 Debugger to trace, break and examine registers with standard Zilog/Mostek mnemonic disassembly displays. Facilities similar to DDT/20 when ordered with Z80 Development Package £30/£7
- DISTEL** — Disk based disassembler to Intel 8080 or TDL/Xitan Z80 source code, listing and cross reference files. Intel or TDL/Xitan pseudo ops optional. Runs on 8080. £35/£7
- DISILOG** — As Distel to Zilog Mostek mnemonic files. Runs on Z80 only £35/£7
- TEXTWRITER III** — Text formatter to justify and paginate letters and other documents. Special features include insertion of text during execution from other disk files or console, permitting recipe documents to be created from linked fragments on other files. Has facilities for sorted index, table of contents and footnote insertion. Ideal for contracts manuals, etc. £75/£3

- POSTMASTER** — A comprehensive package for mail list maintenance. Features include sorted record extraction and label production. A form letter program is included which provides neat letters on single sheet or continuous forms. Requires CBASIC £75/£15
- WHATSIT?** — Interactive data-base system using associative tags to retrieve information by subject. Hashing and random access used for fast response. Requires CBASIC £70/£15
- XYBASIC** Interactive Process Control BASIC — Full disk BASIC features plus unique commands to handle bytes, rotate and shift, and to test and set bits. Available in integer, Extended and ROMable versions.
Integer Disk or Integer ROMable £165/£15
Extended Disk or Extended ROMable £215/£15
- SMAL/80** Structured Macro Assembly Language — Package of powerful general purpose text macro processor and SMAL structured language compiler. SMAL is an assembler language with IF-THEN-ELSE, LOOP-REPEAT-WHILE, DO-END, BEGIN-END constructs £40/£10
- SELECTOR III-C2** — Data Base Processor to create and maintain multi Key data bases. Prints formatted, sorted reports with numerical summaries or mailing labels. Comes with sample applications including Sales Activity, Inventory, Payables, Receivables, Check Register, and Client/Patient Appointments, etc. Requires CBASIC Version 2. Supplied in source code. £185/£12
- CPM/374X Utility Package** — has full range of functions to create or re-name an IBM 3741 volume, display directory information and edit the data set contents. Provides full file transfer facilities between 3741 volume data sets and CP/M files £125/£7
- BASIC UTILITY DISK** — Consists of (1) CRUNCH-14 Compacting utility to reduce the size and increase the speed of programs in Microsoft Basic on TRS-80 Basic. (2) DPFUN — Double precision subroutine package for computing nineteen transcendental functions including square root, natural log, log base 10, sin, arc sin, hyperbolic sin, hyperbolic arc sin, etc. Furnished in source or diskette and documentation £30/£10
- THE STRING BIT** — Fortran character string handling. Routines to find, fill, pack, move, separate, concatenate and compare character strings. Package completely eliminates the problems associated with character string handling in FORTRAN. Supplied with source £30/£10
- BSTAM** — Utility to link one computer to another also equipped with BSTAM. Allows file transfers at full data speed (no conversion to hex), with CRC block control check for very reliable error detection and automatic retry. We use it! It's great! Full wildcard expansions and *.COM, etc. 9600 baud with wire, 300 baud with phone connection. Both ends need one. Standard and M versions can talk to one another £75/£5
- Flippy Disk Kit** — Template and instructions to modify single sided 5 1/4" diskettes for use of second side in singled sided drives £6

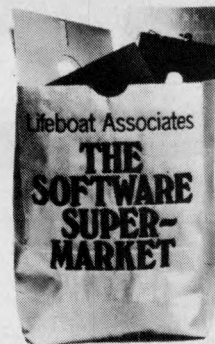

Orders must specify disk type and format, e.g. North Star-Horizon single density.

Add VAT to orders for software (not manuals alone) Add 50p per item postage and packing (minimum £1)

All orders must be prepaid (except COD or credit card) Make cheques POs etc payable to Lifeboat Associates.

Manual costs are deductible from subsequent software purchase

Lifeboat Associates
 32 Neal Street
 London WC2H 9PS
 01-379 7931

(M) Modified version available for use with CP/M as implemented on Heath and TRS-80 Model 1 computers.

(L) User license agreement for this product must be signed and returned to Lifeboat Associates before shipment may be made.

*CP M is a trademark of Digital Research

**Z80 is a trademark of Zilog Inc.

The Software Supermarket is a trademark of Lifeboat Associates.

EFFECTIVE JANUARY 1980

STOP

TOYING WITH MICROCOMPUTERS
The Panasonic range is here.



- * Professionally engineered
- * Full communications capability
- * Basic and Assembler as standard
- * COBOL, PASCAL, FORTRAN available on CP/M
- * Business packages available

Prices range from £3,950 to £5,500

You can obtain your Panasonic Microcomputer from

59 CUTHBERT STREET
LONDON W2 1DG

Tel: 01-262 2444

APT

COMPUTER SYSTEMS LTD

SEE SUE EISENBACH'S
ARTICLE
IN THIS ISSUE

NEW LOW COST PRINTERS

New performance standards in a dot matrix printer for under £500



The Microline 80 offers unmatched flexibility and power for a dot matrix printer of this size, with low power consumption and low noise. The printer is of simple mechanical construction and runs without routine maintenance. The unique print head lifetime is rated to 200 million characters and can be replaced by the user. Standard half inch nylon ribbons and standard roll or fan fold paper contribute to the low operational cost of the Microline 80. Pin and friction paper feed is standard,

with tractor feed optional. The Microline 80 offers as standard a variety of special print features such as character spacing of 5, 10 or 16.5 characters per inch with 40, 80 or 132 print columns and line spacing of 6 or 8 lines per inch, all software selectable. The 16.5 characters per inch spacing allows printing of 132 columns on 210 mm wide paper. The Microline 80 has a parallel, Centronics compatible interface, and a serial RS232 interface is optional.

- **Small size: 342W x 254D x 108H mm**
- **Light weight: 6.5 kg**
- **160 characters, 96 ASCII and 64 Graphics**
- **3 character sizes: 40, 80 or 132 characters per line**
- **No routine maintenance**
- **80 characters per second**
- **9 x 7 matrix**

Marish Wharf, St Mary's Road, Langley, Slough, Berks SL4 1HE Telephone: Slough 49117 Telex: 8812541

X-DATA

Equipment Wholesalers

MICRODIGITAL BOOKS

BEST SELECTION-BEST PRICES-BEST SERVICE
25 Brunswick Street, Liverpool 2 Tel: 051-236 0707 (Mail Order)
*051-227 2535 (All Other Depts)

Accounts Payable & Receivable £9.95	Basic — a unit for Secondary Schools £4.45	8080 Programmer Pocket guide £1.95	Home Computers: A Beginners Glossary and Guide. £4.95	Micro/Computer Interface with the 8255 PPI Chip £10.00
Active filter Cookbook £10.90	Basic Programming £6.95	8080A Bugbook £7.65	Hobby Computers Are Here £3.95	Microformula (TM) £2.95
Adaptize Info. Processing £8.75	Basic Primer £6.95	8080 Programming for Logic Design £5.95	Incredible Secret Money Machine. £4.75	Microsoft (TM) Basic £7.00
Advanced Basic £4.00	Collection of Programming Problems and Techniques £12.00	8080A/8085 Assembler Language Programming. £6.95	Interface Circuits Data Book £3.50	Microprocessor Basics £7.60
Algorithms & Data Structure Equals Programs £14.00	Computer Crime £12.00	8080/8085 Software Design £7.65	Intro to Artificial Intelligence £14.80	Micros — New Directions for Designers £7.60
Anatomy of a Compiler £15.00	Computer Data Directory £3.98	8080 Machine Language Programming for Beginners £5.10	Intro to Computer Prog £4.75	Microprocessors Data Manual £5.50
Apl. — An Interactive Approach £9.50	Computer Lib/Dream machines £5.95	8080 Microcomputer Experiments £10.25	INTRODUCTION TO MICROCOMPUTERS. Vol 0 £5.95 Vol II £18.95	Micros for Business Applications £7.15
Artificial Intelligence £12.00	Computer Models of Thought and Language £17.00	8080 Standard Monitor £9.95	Vol I £5.95 Vol III £11.95	More Basic Computer games £5.50
Artist & Computer £3.96	Computer Power and Human reasons £4.76	8080 Standard Assembler £9.95	Intro to Personal & Business Computing £4.95	Microcomputer Potpourri £1.75
Art Computer Programming £9.50 S/B Vol. 1. £16.45 H/B	Computer resource book Algebra £4.00	8080 Standard Editor £9.95	Intro to Prog. Prob. Solving with Pascal. Schneider Et Al £8.50	Modern Operational Circuit Design £18.60
Art Computer Programming Vol. 2. £16.45	Computer Science a First Course £15.00	8080 Standard Assembler £9.95	Intro to Prog. Prob. Solving with Pascal. Schneider Et Al £8.50	Microprocessor Basics £7.60
Art Computer Programming Vol. 3. £16.45	Computer Science Programming in Fortran IV £7.80	57 Practical Programs Basic £6.40	Instant Basic £7.20	Microprogrammed Apl Implementation £14.75
Assembly Level Programming for small computers £12.76	Computer/Science Projects and Study problems £8.75	First Book of Kim £5.56	Introduction to Basic £7.15	Mos Memory Data Book £2.80
Analysis and design of Digital Circuits and Computer Systems £16.40	Concurrent Pascal Compiler £6.40	Fortran Coloring Book £5.56	Introduction to Basic £7.15	Microprocessor Encyclopaedia Vol. 2. £7.45
Apl. Implementation 4.75	Conference Proceedings of the 1st West Coast Computer Fair £9.56	Fundamentals of Data Structure £15.00	Interfacing and Communications £4.95	9900 Family systems Design & Data Book £7.95
Accent on Basic £4.95	Conference Proceedings of the 2nd West Coast Computer Fair £9.56	Fundamentals and Application of Digital Logic £6.00	Introductory Experiments in Digital Electronics Vol 1 £8.75	1975 U.S. Comp Chess £4.75
About Computers £6.95	Conference Proceedings of the 3rd West Coast Computer Fair £9.58	From the Counter — Bottom Line £8.75	Introductory Experiments in Digital Electronics Vol 2 £7.75	1976 U.S. Comp Chess £4.75
Active Filters £6.45	Consumer Guide—Personal Computers & Micros. £5.00	Fundamentals of Digital Comps £7.25	Introduction to TRS — 80 Graphics £5.25	NCR Basic Electronics £7.15
Analog/Digital Experiments £7.15	Content Addressable Parallel Processors. £11.20	Fortran Programming £6.75	Instructor's manual for Fortran Programming £6.95	NCR Data Communications £7.15
A guided tour of Computer Programming in Basic. £4.16	Computer Dictionary (sams) £6.95	Fortran Workbook £4.75	Illustrating Basic £2.25	NCR Data Processing £6.35
A quick look at Basic £4.45	Computer Dictionary & Handbook £11.95	Fortran Fundamentals £3.45	IC Oplamp Cookbook £8.95	Nascom 1 — Hardware Notes £1.50
Apl II Operators Manual £5.50	Computer & Program Guide for Engineers. £9.45	Fun with Computers & Basic 555 timer £5.35	Introduction to Microprocessors & Computing £2.40	Nascom 1 — Seminar Notes £1.50
Apple II Integer Basic manual £3.55	Computers for the Physicians Office £15.50	50 Circuits using 7400 Series IC's £7.50	Kim I Users Manual £5.00	Optoelectronics Data Book £3.50
Apple II Applesoft Extended Basic Manual £5.75	Computerisation for small Business £9.95	Fortran Fundamentals a short course £2.95	Linear Control Circuits Data Book £4.00	Osbourne Updated Subscriptions Vol. 2. (6 issues) £18.95
Advanced Business, Billing, Inventory, Investments, Payroll £26.95	Computer Quiz Book £5.45	Game Playing with Basic £5.50	Link 68 — M6800 Linking Loader £5.50	Vol. 3. (6 issues) £18.95
An Introduction to Your new Pet. £1.00	Computer Programs that Work. £7.00	Game Playing with Computers £10.20	Little Book of Basic Style £4.75	Vol. 2 & 3. combined £30.00
Basex £6.50	Computer Music £7.00	General Ledger £9.95	Linear IC Principles Experiments £7.16	Binders 2 or 3 £5.75
Basic A Hands on Method £6.50	Computer Data Directory £3.98	Getting Involved with Your Own Computer £4.75	Math Elements for Computer Graphics £10.40	Pascal User Manual & Report £5.25
Basic and the Personal Computer £10.00	Computer Rage (a board game) £6.95	Getting Acquainted with Micros £7.95	Microcomputer — Based Design £8.00	Payroll with cost accounting £12.00
Basic, Basic. £4.80	Clarcia's Circuit Cellar £24.80	Guide to Scamp Programming £4.00	Microcomputer Handbook £15.96	Power Semi-conductor Data Book £7.50
Basic Computer Games Micro. £5.50	Designing with TTL Circuits £10.00	Games with a Pocket Calculator £1.75	Microcomputer Primer £6.35	The Mighty Micro £5.75
Basic from the Ground Up £7.00	Design of Well Structured Prog's Dictionary of Microcomputing. £10.00	Games, Tricks & Puzzles for a Hand Calculator £2.49	Microelectronic £3.25	Z — 80 Programming Manual £4.50
Basic Microprocessors and the 6800. £7.20	Digital Computer Fundamentals. £14.25	How to Build A Computer Controlled Robot. £5.95	Microprocessor £3.25	TTL Databook £7.00
Basic with Business Application £8.40	Dr. Dobbs Journal Vol. 1. £10.00	How To Profit from Your Personal Computer £5.50	Micro Problems Solving Using Pascal £7.50	TI Workbooks (1-6) each £3.00
Basic with style/Programming proverbs. £3.60	Digital IC Equivalents & Pin Connections. £1.25	How To Program Microcomputers £7.50	Microprocessor Interfacing techniques £7.95	TIS 6800 Tracer £4.80
Basic Workbook £3.70	Designing M/Computer Systems £5.40	How You Can Lean To Live With Computers £7.00	Microprocessor Lexicon £2.00	TTL Cookbook £6.95
Best of Creative Computing Vol. 1. £6.95	Editor/Assembler Systems for 8080/8085 Based Systems £11.96	How to buy/use Mini-Micros £7.50	Microprocessor System Design £14.00	Peanut & Jelly Guide to Computing £6.45
Best of Creative Computing Vol. II. £6.95		How to Build a Working Digital Computer £4.60	Microprocessor From Chips to Systems £7.50	The Best of Micro £5.50
Byte Book of Computer Music £7.00		How To Package Your Software £27.50	Mind Appliance £4.75	Z — 80 and 8080 Assembly Prog. £4.80
Beginners Glossary and Guide £5.75		Home computer Revolution £2.75	Modern Operational circuit Design £18.60	6500 Programming manual £10.50
Beginners Basic £7.50			Mondeb M6800 Monitor/debug Microcomputers at A Glance £6.45	6500 Hardware Manual £10.50
Byte Vol I £8.45				Software Gazette 50p

WELCOME
Prices include Postage and Packing anywhere in the UK.

Reconditioned Olivetti Printers incl. paper tape reader/punch and transmission VDU's — 2000 ch buffered screens and Honeywell keyboards alone

DDM HOBBY CORNER
250
225
180

DDM DIRECT DATA MARKETING 44 High Street, Brentwood, Essex CM14 4AJ. Tel. (0277) 229379

DDM DIRECT DATA MARKETING

Printers £11.00/12.00

550 Digital LA24 Decwriter £5.75
6795 Digital LA24 Decwriter with tractor feed £6.45
6455 PET Growth Products £2.95
210 Disk Systems £5.50
400 (Old Rom) £4.00
800 (New Rom) £4.00
Interfaces £4.00
DDM's IEEE to RS232 bidirectional interface

Commodore Pet
Pet 2001-8
Pet 2001-16N
Pet 2022 tractorfed Printer
IEEE to Pet Connector
IEEE to IEEE Connector
C2N Cassette Deck
Commodore Business Software
Business Information, A/Cs, Word Processing
Payroll and Mailing Systems.

Full product list available on application — please return the coupon for more details.

ALL PRICES EX. VAT.

825 **apple**

905 **Microsense Apple**

795 Apple II 16K
840 Apple II 32K
995 Disk Drive with Controller
Disk Drive without Controller
Corvus II Fixed Disk (10 Meg) 3,500

New Apple Software

130 Payroll, Stock Control and Comprehensive Accounting Systems.

SEND DIRECT TO DDM FOR PROLOGIC LISTS & FURTHER DETAILS.

DDM POSTAL

NAME _____

COMPANY _____

ADDRESS _____

PHONE _____

CURRENT MICRO _____

PRODUCT INTEREST _____

North Star Horizon reflects a new age in computing

Can your business, research project or teaching laboratory be made more efficient? Yes. Today's users demand complete, high performance micro computer systems. Expandable to meet future needs and with software capable of immediate application.

The North Star Horizon is the answer. A cleverly balanced configuration: Z80A processor with 12 slot S100 chassis, one parallel and two serial interface ports. Now with double or quad capacity too.

The compact design gives you value for money and economy of space. The Horizon will not break your bank or your desk top.

Quick delivery and nationwide service are only part of the attraction. Add to this the wealth of software available, including the well known CP/M, and you can see why the Horizon has already sold in thousands.

The reason for its success is simple.

The North Star Horizon reflects your needs.



For technical specification and details of your nearest dealer contact Britain's leading North Star Supplier.

 **comart**

PO Box 2, St. Neots, Cambridgeshire.
Tel: (0480) 215005. Telex: 32514
COMART G.

KNIGHT'S T.V. & COMPUTERS

108 Rosemount Place, Aberdeen.
Tel: (0224) 630526.
Telex: 739169.

GRAHAM KNIGHT (GM8FFX) WITH HIS SHARP MZ-80K GENERATING TV PICTURES WHICH ARE BEING TRANSMITTED VIA HIS AMATEUR RADIO AND TELEVISION STATION.

Video signals from the Sharp computer are converted to 28MHz and then to 435MHz. Professional standard, vestigial sideband, fast scan TV pictures are then transmitted using 150w of power to feed 176 element antenna. Computer generated pictures have been received over 150kms.



Dear Microfans,

We've been selling Sharp high technology products for the last seven years – we really are at home with Sharp. In seven years we have never unpacked a single faulty TV, radio, cassette, or calculator – Sharp computers are built to the same high standards. We like the MZ-80K because it has a Z80 processor, 20K of RAM, a super powerful 4K monitor in ROM, upper and lower case letters and unequalled graphics.

The October Personal Computer World exclusive pre-release benchtest and review concluded: "If I want to spend £600 on a personal computer, my choice will be between PET, TRS-80 and MZ-80K. Without question the MZ-80K has the smartest packaging, the fastest BASIC, and marginally better system software". Schools have been very impressed with the accuracy of the mathematical functions and they like the way Sharp's extended Basic is loaded on tape – Kobol, Fortran and Pascal program tapes are presently being developed. When available they will make the Sharp ideal for teachers, who will be able to change programming languages by simply loading another tape.

With each order for a Sharp MZ-80K we supply 30 free programs including GAMES: STAR TREK, 3D MAZE, TEN PIN BOWLING, OTHELLO, SKI SLOPE, B52 ATTACK, SPACE FIGHTER, SNAKE ISLAND, STAMP OUT, POKER etc. MATHS: Pythagorean theorem fractions/decimal, graphs, squares Poisson figures, and a special 'Teach tables' program. All these fully utilise the Sharp graphics and Music commands. We also give free with each MZ-80k four very important programs which can only be obtained from us.

1. MEMORY DUMPER: which shows 8 bytes per line and displays character interpretation of those bytes.
2. DISASSEMBLER: displays object code and source statements for any block of memory including the monitor, basic and expansion areas.
3. HEX POKER: machine code loader which handles eight bytes at a time without the need for spaces between bytes.
4. BYTE SEARCHER: amazing program which finds specified byte contents in any part of the memory. Single byte or up to four sequential bytes can be located and the address displayed.

With the approval of Mr. Paul Streeter, the manager of Sharp Computers, we have formed the SHARP USERS CLUB. Membership will cost £3 annually but will be free if you purchase your MZ-80K from Knight's. The first edition of the SHARP USER GROUP NEWSLETTER is now available with reports from the Japanese Micro Exhibition, articles showing how to take advantage of the SHARP music commands which allow semitones, and notes from a minim down to a 32nd to be played over any three octaves at seven tempos. We already have members of the Sharp User Group in Germany, Hong Kong, Australia and Japan, thus ensuring that members will hear of the latest Sharp developments on a worldwide basis. We have offers of software from Japan and feel that the Sharp User Club will play an important part in the development and use of the MZ-80K.

During the next few weeks we will be attending exhibitions and giving lectures at conferences and conventions. On 9 March we will be lecturing at the Radio Society of Great Britain's VHF Convention, demonstrating how our Sharp and Nascom computers can be used to send and receive Morse and radio teletype automatically, track communication satellites, and display distance and magnetic bearing to any location in the world. On 15 March, and again on 15 April, we will be at the Radio, Electrical, Television, Retailers Association conference demonstrating how we use the Sharp MZ-80K for diagnostic servicing of television sets. We have developed programs which enable completely unskilled staff to repair television sets and an article on this subject, written by us for 'Dealer Magazine' is reprinted in the Sharp User Group Newsletter. From 8–10 May we will be at the Radio Society Exhibition at Alexandra Palace. We look forward to seeing you at one of these events.

Happy computing,
Graham Knight,
(for A. & G. Knight)

P.S. Almost forgot to say the Sharp MZ-80K costs £520 plus VAT. Delivery is free anywhere in the UK and we include the free programs and Sharp User Club membership detailed above. We also stock the Nascom range and full details of Sharp and Nascom products will be sent to you on receipt of a large s.a.e.

P.P.S. We accept payments by credit card in case you want to keep the Barclay and Access computers busy.



MSI 6800: At the root of every good system.

SEED

Strumech Engineering Electronic Developments Limited
Portland House, Coppice Side, Brownhills, Walsall, West Midlands. Telephone (279) 4321

The Rohan Computing Collection.....

Qume
CIFER
digital
OKI

Sprint 5/45 Daisywheel printer/terminal. Ideal for word processing and general use. RS 232 standard, successfully installed on PET's, Apples, Tandy TRS 80, Sorcerer etc...

Wordstar The best word processor for cpm systems. Special version with addressing facility.

Wordcraft Converts a 32k PET & discs into a superb word-processor.

VDU's The most legible VDU's on the market, superbly made and British. All black or seafoam finish. Detachable 62 or 102 key keyboards. Lear Seigler and VT52 emulation. FROM £600.00

2684 Microcomputer as VDU's but 2nd Z80, integral disc and CPM, graphics facility.

LA 34 The best desk top, full width, 30cps terminal, 10, 12, 16 characters per inch, optional tractor.

LS 120 180 cps terminal.

11/03 & 11/23 computer systems available with CAP MicroCOBOL, accounts, Autoclerk.

Microline 80 The smallest and quietest desk top printer available (61db) 5, 10 or 16 characters per inch, 40, 30, 132 wide. Standard machine will take 9.5 inch sprocket feed paper, roll and single sheet. With centronics interface, PET IEEE or user port interface, Tandy TRS 80 directly to keyboard unit without expansion box. FROM £499.00.

TNW 2000 The only bi-directional PET to RS 232 interface we know that runs Qumes etc. at full speed i.e. 1200 baud £165.00. Also available Teletype 43, North Star, Rair Black Box.

TRADE & EDUCATIONAL ENQUIRIES WELCOME,

Rohan Computing 52 Coventry St., Southam, Warwickshire CV33 0EP. Tel: Southam (092681) 4045

Possibly the most cost effective word processors in the world.



The Vector Graphic MZ

- *4MHZ Z80A CPU
- *48K ram
- *630K Bytes disk storage
- *Serial port and two parallel ports
- *Prom/ram Board with monitor
- *MDOS Operating system
- *Z80 Assembler
- *Basic Interpreter

Plus a large range of CP/M compatible software including Fortran, Cobol, Macro assemblers etc

The Vector Graphic System B

- Complete Vector MZ system plus:
- *Vector Mindless terminal*
- Flashwriter 2 video board (24 x 80)*
- *Software driver on prom*
- MZOS North Star compatible DOS*
- *CP/M configured by Almarc*

DATA SYSTEMS LTD

906 Woodborough Road, Nottingham. Telephone: (0602) 625035

Z-Plus Microcomputer System

Over One Megabyte Disk Storage • 4 MHz Z-80 Processor

Two Serial and Centronics Parallel I/O Ports • 64k Memory

An alphanumeric keyboard • Including System Desk

Price **£3950** plus VAT

DISK CAPACITY:

The proven, industry-standard Micromation Doubler controls the two-drive floppy disk sub-system. The disk sub-system stores one megabyte. The Micromation Hard Disk Controller is available too, so you can add a hard-disk sub-system based on the Shugart 14" SA 4000 family Winchester disk. (12.5 and 24.8 Megabytes).

CPU/MEMORY:

Micromations's innovative Z-64 Board delivers 64K Dynamic RAM memory and the Z-80A microprocessor running at a full four MHz with no wait states.

SERIAL/PARALLEL I/O

The Complete I/O Board provides 2 serial ports with full handshake, and RS-232 interface, to drive most terminals and printers.

Centronics parallel port provided as standard plus optional interface and software drives for parallel daisy wheel printers.

POWER SUPPLY:

The constant voltage power supply assures reliable operation under all power conditions. The system is fully ventilated, for cool, dependable operation.

TERMINAL:

An alphanumeric keyboard with 95 keys and numeric pad, character display (24 lines of 80 characters per line) on a 15 inch screen.

BUS:

With the flexibility of the S-100 Bus you can select from a variety of components, such as real-time clocks, memory management boards modems to expand your system.

There are seven extra slots on the shielded S-100 bus motherboard. Active termination – of course.

OPERATING SYSTEM:

The Z Plus utilises the latest version of **CP/M 2.0** the industry standard floppy and hard disk operating system. MP/M will also be available in the near future. There is no easier system to use, you need never worry whether you are operating in single or double density – the system takes care of it.

SYSTEM SOFTWARE:

The Z-Plus supports a full range of software including **CIS COBOL** and forms, **MBASIC, FORTRAN, APL, PASCAL.**

APPLICATIONS SOFTWARE:

Word processing, payroll, inventory, all accounting functions are just some of the application packages available.

A main frame software house are at the stage of completing the full range of accounting packages for the Z-Plus. They will also undertake any specialised systems work as will Rostronics.

TRAINING:

Training courses are available on system operating and application software.

INSTALLATION AND MAINTENANCE:

For an additional charge Rostronics will undertake delivery and maintenance of the systems throughout the U.K.

PERIPHERALS:

A full range of printers, specialised terminals, computer stationery, and peripheral furniture are also available.



FOR DEMONSTRATIONS CONTACT ONE OF OUR OFFICES:

ROSTRONICS

LIMITED

115-117 WANDSWORTH HIGH STREET, LONDON SW18 4JP
Telephone: 01-874 1171 Telex: 8813089 INTPRM G

8 ROYAL CRESCENT,
GLASGOW.
041 332 7642



MICROCOM

For Hardware, Software, Peripherals

PET 2001



from
£475

commodore
authorised dealers

TRS 80



from
£365

From Radio Shack Corp.

APPLE II

from
£750

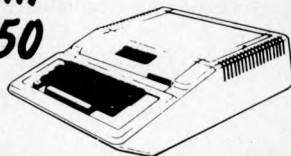

apple & ITT 2020
authorised dealers

SORCEROR

from **£740**

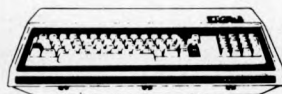

Exidy
authorised dealers

COMPUCOLOR

from
only
£999



for computer with colour monitor, keyboard and integral disk drive. Second disk drive £316.00

BASIC SYSTEMS

PET 3016 (16K RAM and large keyboard)*	£675.00	PET 2001-8 (PET with 8K memory + integral cassette)	£475.00
PET 3032 (32K RAM and large keyboard)*	£795.00	PET 3008 (8K) with large keyboard	£475.00
		PET C2N External Cassette Deck	£53.00
ACCESSORIES			
IEEE/RS232 Serial Interface 'A' Output only	£106.00	IEEE-448/Centronics type parallel Interface	£45.00
IEEE/RS232 Serial Interface 'B' Input/Output	£186.00	IEEE to Pet Cable	£19.00
Programmers Toolkit - 10 powerful new commands for your Pet - plug in ROM chip 8K and 16/32K resp	£75/£55	IEEE to IEEE cable	£24.00
		PETSET 1 16 Channel AD Converter c.w. all interfacing requirements	£166.00

BASIC SYSTEMS

TRS 80, 4K Level I consisting of Keyboard with 4K memory, Video Unit, Cassette Drive and 240v power supply unit	£365.00	TRS 80, 16K Level II (as above with 16K memory)	£499.00
TRS 80, 4K Level II (as above with Level II Basic)	£425.00	TRS 80, Expansion Interface with 16K RAM	£275.00
		TRS 80, Expansion Interface with 32K RAM	£360.00
ACCESSORIES			
TVJ 232C serial Interface	£35.00	Radio Shack Phone Modem	£160.00
Centronics Parallel Printer Interface (direct to keyboard)	£40.00	UHF Modulators (encased with leads for 625 lines)	£20.00
TRS 80, Voice Synthesizer	£345.00	RAM upgrade (4-16K, 16-32K, 32-48K) supplied and fitted at our premises (Kit £80.00)	£85.00
TRS Voxbox - speech recognition system	£135.00	S100 interface for TRS 80 (6 slots)	£375.00
TRS 80, Numeric Key Pad supplied and fitted	£49.00	TRS80 CPU 3 speed mod.	£26.00

BASIC SYSTEM

Apple II Plus computer - APPLESOFT extended basic in ROM - (16K RAM) - video output	£695		
ACCESSORIES			
Apple black and white modulator for domestic TV	£20.00	Real time clock/calendar card - 1/1000 sec to 388 days with interrupt, software controllable	£128.00
Eurocolor card - provides colour on domestic TV	£79.00	Speechlab - provides voice control for the Apple	£127.00
Parallel Printer Interface Card	£110.00	Supertalker - adds human speech output!	£205.00
High Speed Serial (RS232C) Interface Card	£113.00	ALF Music Synthesizer Card	£180.00
Communications Card	£130.00	A1-02 Data Acquisition Card	£180.00
Centronics Card	£130.00	Graphics Tablet	£462.00
Integer Basic Firmware Card	£116.00	AC Line Controller	£270.00
PASCAL language system - includes language card to provide user with PASCAL, PALSOFIT & INTEGER BASIC	£299.00	RAM Upgrade (16-32K, 32-48K)	£69.00
		Hobby Prototype Card	£20.00
		Romplus - u, l/c, mixed text/graphics	£105.00

BASIC SYSTEMS

Sorceror 16K RAM (inc. UHF Modulator)	£740.00	Sorceror 32K RAM (inc. UHF Modulator)	£840.00
ACCESSORIES			
Exidy Video Monitor (High Resolution)	£240.00	Exidy S100 Bus with Interface + motherboard PSU	£200.00
Exidy Video Disk Unit	P.O.A.	CP/M for Sorceror on Disk	£145.00

ADVANCED SYSTEMS

Altair, Equinox, Billings, Heath, Rair, Horizon. Installations include hard disk and multi tasking. Prices on Application.	CORVUS 11mb Hard Disk for TRS 80 & Apple. Complete with interface & D.O.S.	TANDY Model II now available for demonstration at our Camberley Office. (by appointment only)	P.O.A.
	£3500.00		

SPECIAL OFFERS

Microprinterm 879 serial printer 80 cols 120 cps	£595.00
Black Box parallel printer 80 cols impact head	£195.00
Compucolor 16K integral disk drive + extended keyboard (101 keys)	£999.00
Computhink Dual Disk Drive (400K) for Pet 2001-8 (requires 24K expandamem)	£645.00
Expandamem - 24K memory expansion board for Pet 2001-8	£275.00

PUTERS ETC

Consultancy and Competitive Prices.

Registered business name



DISKS

PET	
CBM 3040 (dual drive) 343K User storage*	£795.00
Computhink (dual drive) 400K storage	£895.00
Computhink (dual drive) 800K storage	£1145.00
TRS80	
Shugart drive	£315.00
Micropolis drive	£315.00
Percom FD200 drive 110v	£299.00
Micropolis Dual Drive (394K storage)	£995.00
Corvus Hard Disk (11mb)	£3500.00
APPLE	
Apple Drive - 116K storage 1st drive	£349.00
Apple Drive - 116K storage 2nd drive	£299.00
Corvus Hard Disk (11mb)	£3500.00
SORCEROR	
Exidy - 143K storage	£495.00
Exidy Dual drive (630K storage)	£1195.00
Corvus Hard Disk (11mb)	£3500.00

PRINTERS

PET	
CBM 3022 (80 col with PET graphics - tractor feed)*	£675.00
TRS80	
TRS 80 Screen Printer (text + graphics) (110v)	£445.00
New Radio Shack Micro Printer	£245.00
GENERAL	
Teletype 43 KSR Serial (pin or pinch feed, 132 cols)	£825.00
Teletype 33 KSR Serial (110 Baud) Reconditioned	£450.00
OKI - parallel/serial (pin or pinch feed, 40, 80, 132 cols selectable)	£499.00
Centronics 779 parallel (tractor feed, 132 cols)	£825.00
Anadex DP 8000 serial/parallel (112 cps bi-directional tractor feed, 40, 80 cols selectable)	£560.00
Centronics Micro Printer (20, 40, 80 cols selectable)	£395.00
Heath WH 14 serial (80, 96, 132 cols selectable)	£475.00
QUME daisy wheel printers	P.O.A.
TCM100/MICROHUSH Thermal Printer (40 cols) inc. interface for PET/APPLE/TRS80	£266.00

ETC.

Diskettes 5 1/4" (blank) boxed (min order 10) each	from £3
C12 Cassettes (min order 10) each	£0.35p
Ansaback 'phonemate' telephone answering machine, voice operated twin cassette	£190.00
Pace EZ-PHONE - Cordless Telephone	£225.00
Computalker Speech Synthesis for S100	£350.00

BOOKS - Large range of microcomputer related books and magazines

TERMINALS

Pentland V1, 80 char./24 lines 2 page memory	£580.00
--	---------

PROGRAMMABLE CALCULATORS. TEXAS

INSTRUMENTS. Business Programmable Calculators - complete range. Send for list + prices. (We are authorised TI dealers).

IF YOU DON'T SEE IT - ASK IF WE HAVE IT

SOFTWARE

PET

PETSOFT authorised dealers - over 160 programmes on cassette and disk. Send for catalogue.

STAGE ONE COMPUTERS S/W dealers - PETAID, Stock Control, etc. Send for list

74 Common BASIC Programs on one tape	£15.00
PETACT Business Software - Sales and Purchase Ledger	P.O.A.

CBM DISK-BASED BUSINESS SOFTWARE:-

Commodore Word Processor powerful word processor package	£75.00
CSTOCK - STOCK CONTROL - gives complete stock report	£150.00
CBIS - BUSINESS INFORMATION SYSTEM - Storage & Retrieval of all types of company records	£150.00

COM ACCOUNTS - Full Financial Business Accounting System incl:

Sales, Purchase, Nominal Ledgers (integrates with C Stock, and C INV)	£610.00
PAYROLL - Handles hourly, weekly or monthly paid employees (Tape)	£50.00

(We are authorised CBM Business Software Dealers) Send for List.

GD 1001 - Assembler Development System	£50.00
--	--------

GD 010 - Lisp Interpretive Language (Artificial intelligence)	£75.00
---	--------

JOYSTICK PACKAGE - complete with connector software	£25.00
---	--------

CAR INSURANCE QUOTATIONS - computerised car insurance quotation suitable for insurance brokers (TVJ S/W)	£25.00
--	--------

MORTGAGE QUOTATIONS - suitable for agents/mortgage brokers (TVJ S/W)	£25.00
--	--------

TRS 80

COMAC III SUITE - computerised accounting for TRS 80 (TVJ SOFTWARE)	£75.00
---	--------

STOCK CONTROL - complete inventory control - recorder level - P/O's etc.	£115.00
--	---------

CP/M	£95.00
------	--------

CBASIC	£75.00
--------	--------

FORTAN includes compiler, relocatable assembler text editor and linking loader	£95.00
--	--------

PASCAL - tomorrow's programming language today	£195.00
--	---------

ELECTRIC PENCIL - powerful word processor allows full cursor movement, insert/delete, string search block movement, adjustable line length, justification on cassette	£65.00
---	--------

ELECTRIC PENCIL as above - disk version	£115.00
---	---------

LOWER CASE MOD KIT for Electric Pencil	£28.00
--	--------

DATA MANAGEMENT/REPORT GENERATOR - easily formats disk files, allows entry, edit, delete and list of records and retrieves data for display or calculation on screen or printer	£200.00
---	---------

RSM-2D DISK MONITOR - powerful system manipulates disk data, has Z-80 break routine	£25.00
---	--------

ISAM - INDEX SEQUENTIAL ACCESS METHOD - sub routines to facilitate control of random data files	£45.00
---	--------

ST80D communications software	£60.00
-------------------------------	--------

NEWDOS - TRSDOS with corrections and enhancements	£25.00
---	--------

NEWDOS+ - as above but with further facilities:-	£45.00
--	--------

KBFIX, Renum, Screen to printer in one step, DOS commands from BASIC, Level I in II, Superzap, Disassemble, load and save faster, list variables	£49.00
--	--------

LIBRARY 100 - an assortment of 100 programs	£39.00
---	--------

SARGON CHESS - 16K Level II - the 1979 Champ Version I	£14.00
--	--------

SARGON CHESS - 16K Level II - the 1979 Champ Version II	£24.00
---	--------

APPLE

EASYWRITER - word processing system.	£85.00
--------------------------------------	--------

A2FP FUNCTION PLOTTER - Comprehensive graph plotting	£18.00
--	--------

PILOT - programming language suitable for educational purposes	£35.00
--	--------

U-DRAW II - High Resolution graphics editor. Create a figure then intake, expand, contract etc and store on disk	£27.00
--	--------

PROGRAMMERS AID No. 1 - Plug-in ROM gives numerous facilities including renumber, merge, high res in integer etc.	£29.00
---	--------

3D GRAPHICS - High res plotting in 3D!	£30.00
--	--------

LISP - programming language suitable for research in artificial intelligence	£30.00
--	--------

3-MILE ISLAND - Complex disk based game simulating nuclear reactor	£27.50
--	--------

MUSE authorised dealers. Many programs on cassette and disk. Send for list.

SORCEROR many programs available - send for list.

COMPUCOLOR full lists available.

* 5% DISCOUNT ALLOWED FOR EDUCATIONAL ESTABLISHMENTS



T&V JOHNSON (MICROCOMPUTERS ETC) LTD

Member of the TV Johnson Group of Companies

Camberley (Head Office)

165 London Road, Camberley
Surrey, GU15 3JS.

Telephone (0276) 62506

Oxford

148 Cowley Road, Oxford
OX4 1JJ.

Telephone (0865) 721461

Bristol

48 Gloucester Road, Bristol
BS7 8BH

Telephone (0272) 422061

Hours of business

Mon-Fri. 9.30 - 5.30

Sat. 9.30 - 1.00

+ Ansaback eves

and w/ends.

Telex 858893

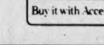
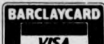

PRICES EXCLUDE VAT, FREIGHT & HANDLING SEND OR PHONE FOR PRICE LIST & BROCHURES (All prices correct at time of compilation)

Directors: Dr. R.V. King BA, MIEE

S.G. Johnson, BSc. (Hons.)

T.S. Johnson, ABIBA, ACMB, FBSC, MBIM

A.S. Barton ACII, ABIBA, CdiPAF.

Branches at:

Birmingham, Bristol, Edinburgh, Leeds, London, Louth, Newmarket, Nottingham, Oxford, Byfleet, Wokingham.

MERSEY MICRO SHOW

**The Adelphi Hotel, Liverpool
30 April, 1, 2 May 1980**

Show The Flag

Microcomputer Exhibitors—the huge North West market awaits you. The first ever major micro event in the area has the approval of the Department of Industry and is supported by the North West Industrial Development Association, Liverpool University, and various organisations throughout the North West. Wave your company's flag with the following:

B & B Computers, Celdiss, Chess Consultancies, Commodore Dealers, Cortex, Cytek, Department of Industry (MAP), Dicoll Electronics, Downs Office Equipment, Euro—Calc, Fylde Computers, GMS Computing, A.M. Jacquard, Kenitron Electronics, Microtech, Microdigital, Microsystems Services, N.W. Industrial Development Association, Research Machines, Rockliff Brothers, Rostronics, Stack, Tangerine, K.H. Vickers.

The Seminars will introduce and explain in non-technical terms how the micro can be adapted for use in all types of businesses. Wednesday is devoted to industrial applications and Thursday will introduce the fascinating world of personal computers. Friday takes a look at the electronic office and shows how word processors and other electronic devices are already revolutionising offices throughout the country.

Book for all three days—or any one day!

Special Offer Admission to the Exhibition will be by ticket only (£1.50 inclusive of VAT) available at the door. A special offer of 3 tickets for £3 is available on tickets purchased before 18 April 1980. These tickets can be obtained from the Online office and will allow the holder ease of access to the exhibition in the event of queues.

Online Conferences Ltd., Argyle House, Joel Street, Northwood Hills, Middx. HA6 1TS. Tel: Northwood (09274) 28211

onTime

I am interested in exhibiting Please send me Mersey Micro Seminar details
Please send tickets for Exhibition SAE and cheque enclosed
Name _____
Address _____
Tel No _____

PW

Video genie system



The Video Genie System, EG 3003.
At last, value for money in microcomputers.

£425 incl VAT

- * 16k User RAM plus 12k Microsoft BASIC in ROM
- * Fully TRS 80 level II software compatible
- * Huge range of software already available
- * Self contained, cassette, PSU & UHF modulator
- * Simply plugs into video monitor or UHF TV
- * Full expansion capability for disks & printer

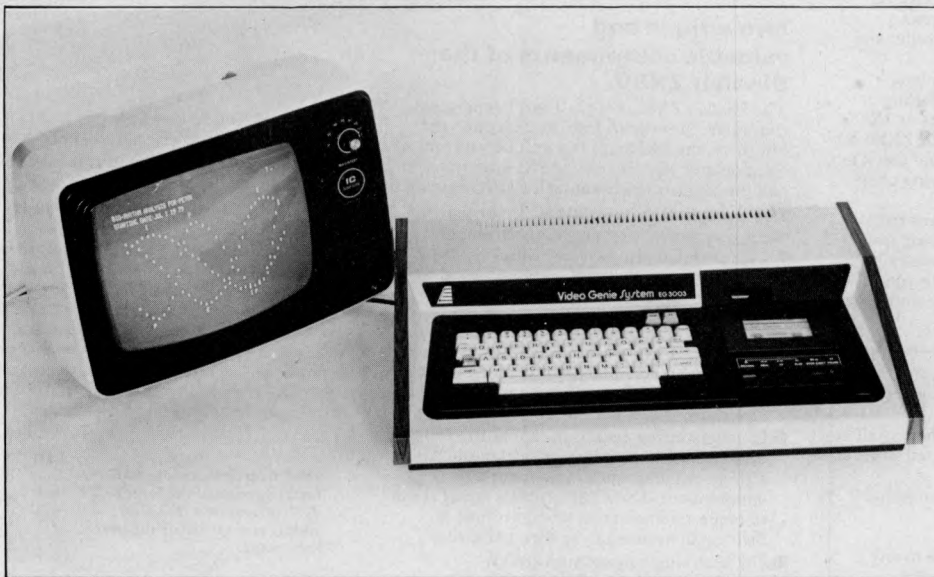

LOWE ELECTRONICS

LOWE ELECTRONICS LIMITED
BENTLEY BRIDGE
CHESTERFIELD ROAD
MATLOCK
DERBYSHIRE
DE4 5LE

For full details please contact:
Telephone 0629 2817 or 2430
Telex 377482 LOWLEC G

TRADE ENQUIRIES WELCOME

Britain's first comp

A complete personal computer for a third of the price of a bare board.

Also available ready assembled for £99⁹⁵

The Sinclair ZX80.

Until now, building your own computer could easily cost around £300 – and still leave you with only a bare board for your trouble.

The Sinclair ZX80 changes all that. For just £79.95 you get *everything* you need to build a personal computer at home... PCB, with IC sockets for all ICs; case; leads for direct connection to your own cassette recorder and television; everything!

And yet the ZX80 really is a complete, powerful, full-facility computer, matching or surpassing other personal computers on the market at several times the price. The ZX80 is programmed in BASIC, and you could use it to do quite literally anything from playing chess to running a power station.

The ZX80 is pleasantly straightforward to assemble, using a fine-tipped soldering iron. Once assembled, it immediately proves what a good job you've done. Connect it to your TV set... link it to an appropriate power source*... and you're ready to go.

Your ZX80 kit contains...

- Printed circuit board, with IC sockets for all ICs.
- Complete components set, including all ICs – all manufactured by selected world-leading suppliers.
- New rugged Sinclair keyboard, touch-sensitive, wipe-clean.
- Ready-moulded case.
- Leads and plugs for connection to any portable cassette recorder (to store programs) and domestic TV (to act as VDU).
- FREE course in BASIC programming and user manual.

Optional extras

- Mains adaptor of 600 mA at 9 V DC nominal unregulated (available separately – see coupon).
- Additional memory expansion board plugs in to take up to 3K bytes extra RAM chips. (Chips also available – see coupon.)

*Use a 600 mA at 9 V DC nominal unregulated mains adaptor. Available from Sinclair if desired (see coupon).

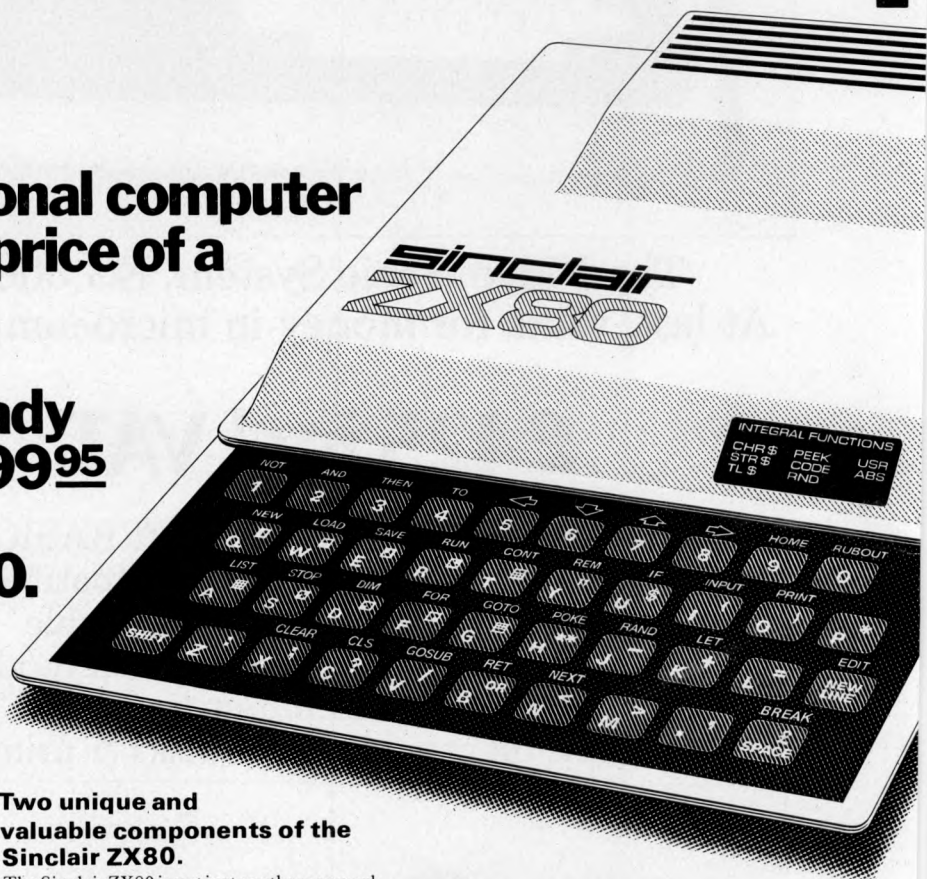

Two unique and valuable components of the Sinclair ZX80.

The Sinclair ZX80 is not just another personal computer. Quite apart from its exceptionally low price, the ZX80 has two uniquely advanced components: the Sinclair BASIC interpreter; and the Sinclair teach-yourself BASIC manual.

The unique Sinclair BASIC interpreter... offers remarkable programming advantages:

- Unique 'one-touch' key word entry: the ZX80 eliminates a great deal of tiresome typing. Key words (RUN, PRINT, LIST, etc.) have their own single-key entry.
- Unique syntax check. Only lines with correct syntax are accepted into programs. A cursor identifies errors immediately. This prevents entry of long and complicated programs with faults only discovered when you run them.
- Excellent string-handling capability – takes up to 26 string variables of any length. All strings can undergo all relational tests (e.g. comparison). The ZX80 also has string input to request a line of text when necessary. Strings do *not* need to be dimensioned.
- Up to 26 single dimension arrays.
- FOR/NEXT loops nested up to 26.
- Integer names of any length.
- BASIC language also handles full Boolean arithmetic, conditional expressions, etc.
- Exceptionally powerful edit facilities, allows modification of existing program lines.
- Randomise function, useful for games and secret codes, as well as more serious applications.
- Timer under program control.
- PEEK and POKE enable entry of machine code instructions, USA causes jump to a user's machine language sub-routine.

- High-resolution graphics with 22 standard graphic symbols.
- All characters printable in reverse under program control.

... and the Sinclair teach-yourself BASIC manual.

If the features of the Sinclair interpreter listed alongside mean little to you – don't worry. They're all explained in the specially-written 96-page book *free* with every kit! The book makes learning easy, exciting and enjoyable, and represents a complete course in BASIC programming – from first principles to complex programs. (Available separately – purchase price refunded if you buy a ZX80 later.)

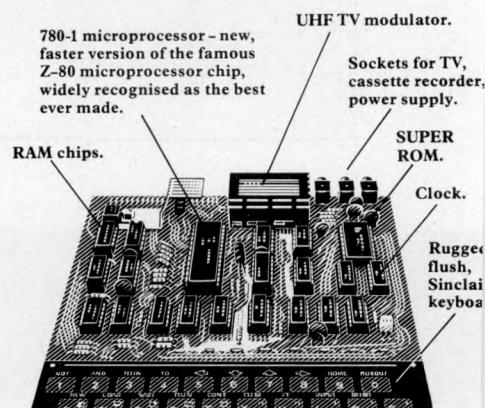

Complete computer kit.

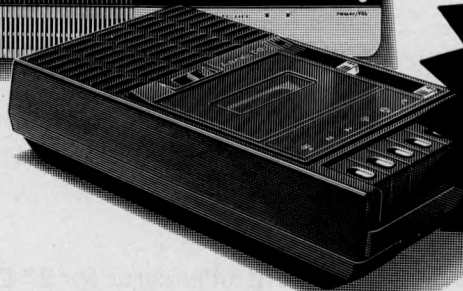

£79⁹⁵

**Including VAT.
Including post and
packing.
Including all leads
and components**

**Fewer chips,
compact design,
volume production –
more power per pound!**

The ZX80 owes its remarkable low price to its remarkable design: the whole system is packed onto fewer, newer, more powerful and advanced LSI chips. A single SUPER ROM, for instance, contains the BASIC interpreter, the character set, operating system, and monitor. And the ZX80's 1K byte RAM is roughly equivalent to 4K bytes in a conventional computer, because the ZX80's brilliant design packs the RAM so much more tightly. (Key words, for instance, occupy just a single byte.)

To all that, add volume production – and you've that rare thing: a price breakthrough that really is a breakthrough.

**The Sinclair ZX80. Kit: £79.95.
Assembled: £99.95. Complete!**

The ZX80 kit costs a mere £79.95. Can't wait to have a ZX80 up and running? No problem! It's also available, ready assembled, for only £99.95.

Whether you choose the kit or the ready-made, you can be sure of world-famous Sinclair technology – and years of satisfying use. (Science of Cambridge Ltd is one of the Sinclair companies owned and run by Clive Sinclair.)

To order, complete the coupon, and post to Science of Cambridge for delivery within 28 days. Return as received within 14 days for full money refund if not completely satisfied.



Order Form

To: Science of Cambridge Ltd, 6 Kings Parade, Cambridge, Cambs., CB2 1SN.
Remember: all prices shown include VAT, postage and packing. No hidden extras.

Please send me:

Quantity	Item	Item price £	Total £
	Sinclair ZX80 Personal Computer kit(s). Price includes ZX80 BASIC manual, excludes mains adaptor.	79.95	
	Ready-assembled Sinclair ZX80 Personal Computer(s). Price includes ZX80 BASIC manual, excludes mains adaptor.	99.95	
	Mains Adaptor(s) (600 mA at 9 V DC nominal unregulated).	8.95	
	Memory Expansion Board(s) (takes up to 3K bytes).	12.00	
	RAM Memory chips – standard 1K bytes capacity.	16.00	
	Sinclair ZX80 Manual(s) (manual free with every ZX80 kit or ready-made computer).	5.00	
		TOTAL	£

NB. Your Sinclair ZX80 may qualify as a business expense.

I enclose a cheque/postal order payable to Science of Cambridge Ltd for £ _____

Please print

Name: Mr/Mrs/Miss _____

Address _____

PCW/3/80

**sinclair
ZX80**

Science of Cambridge Ltd

6 Kings Parade, Cambridge, Cambs., CB2 1SN.
Tel: 0223 311488.

FRAMPLAN COMPUTER SYSTEMS

HARDWARE

16k I.T.T. 2020 Microcomputer	£650
16k R.A.M. Upgrade kit	£60
Disk Drive and controller	£350
Parallel Printer Interface card	£95
Anadex Printer	£525
Numeric Key Pad	£75
Music Composer	£120

STATIONARY

5¼ Verbatim Disks	£2.50 each
Box Printer Paper	£13.60 per box
Other stationary available upon request	

SOFTWARE

Agricultural Package	£2565
Desk Top Management (Financial analysis)	£125
Visi-Calc (Promblem Solving)	£95
Rent Master	£250
Word Processor	£125
Payroll	£200
Data Base	£125
Quotation System	£350
Games & Utility Disks Vols.1-6	£20 each
Documentation Utility Disk	£50

ALL MACHINERY EXCEPT PRINTER (3 MONTHS) GUARANTEED FOR 12 MONTHS

IMPORTANT We now have available – controller cards for 8" Drives I.B.M. compatible, suitable for Apple/I.T.T. Price on application

ORDERING INFORMATION:

Delivery/Insurance extra. All prices exclude V.A.T. @ 15%
Price list correct at time of publishing, subject to change without notice.
FRAMPLAN, NETHERTON, ROSS-ON-WYE, HEREFORDSHIRE:
Tel: Ross 4321

Offices also at Melton Mowbray, Northallerton, Aberdeen

REAL-TIME SPECTRUM ANALYZER

£340

You can now buy, for about one-sixth the price of current products, a third-octave spectrum analyzer with more features and capabilities than were previously available at any price. What's the catch? If you don't already own a Commodore PET computer (or, soon, a Radio Shack TRS-80 or Apple), you'll have to get one. This will raise the price to somewhat under one-half the price of competing products, but of course you'll also have a COMPUTER!

The THS 224 REAL-TIME FREQUENCY ANALYZER comprises a single circuit board which installs inside the PET. This board contains a set of 31 third-octave filters (20 Hz to 20 kHz), detectors, an analog-to-digital converter, a 1K Read Only Memory containing machine language routines which allows the PET processor to interface with the Analyzer, and the peripheral circuitry necessary to transfer analog data into the PET memory. The simplest BASIC program required to turn the PET into an analyzer is only three statements long! Much longer programs can be written to allow complete user interaction with the analyzer, including many new forms of statistical signal processing, curve weighting, voice recognition etc.



EXPANSION MEMORY

with space for eprom

Price break-through

**24k
£280**

**32k
£325**

All items can be seen and demonstrated at our London showroom. Orders accepted by mail, phone or in person.

**PETS 8k
from £495**

PET IS A TRADEMARK OF COMMODORE BUSINESS SYSTEMS

Prices exclude VAT. Send or phone for further details and brochure.

Access, Barclaycard, and Trustcard accepted.



UK Distributors

Feldon Audio Ltd.,

126 Great Portland Street, London W.1. Tel: 01-580 4314. Telex: London 28668

MEET THE FAMILY



... THERE MUST BE ONE HERE FOR YOU

The Exidy family is a sophisticated range of products designed to meet the ever increasing variety of computing needs, including home and business uses, educational and laboratory applications, industrial process control etc. The Exidy range has been designed with built-in growth capacity to take the risk factor out of computer investment. The Sorcerer Computer now has a memory expansion capability from 8K up to 48K within its own cabinet, enabling the system to grow with your needs plus the ability to add many additional plug-in facilities such as disk drives and pre-programmed ROM PAC's.

The standard configuration includes a 63 key typewriter-style keyboard and a 16 key numeric pad. Remote control for dual cassettes. Serial RS232 and parallel interfaces, Z80 processor, 4K resident operating system, 8K Microsoft BASIC in separate plug-in ROM PAC cartridge, 64 character x 30 line display, 128 upper/lower case ASCII character set and 128 user defined graphic symbols, operators manual, introduction to basic programming, connecting leads. All Exidy equipment is backed up by a 12 month warranty covering both parts and labour.

The Word Processing ROM PAC features auto wraparound, dynamic cursor control, variable line length, global search and replace, holding buffer for re-arrangement of text, right justification, line width and line to line spacing, underlining or boldfacing, text merging and a macro-facility permitting tasks such as formletter typing, multiple column printing of automatic forms entry.

Now contact your nearest dealer:

The NORTH

T.W. COMPUTERS, 293 London Road, Hazelgrove, Stockport. 061 4568187
BASIC COMPUTING, Oakville, Oakworth Road, Keighley, W. Yorkshire. 0535 65094
E. S. MICROCOMPUTERS, 7 Berkeley Precinct, Eccleshall Road, Sheffield S11 8PN. 0742 668767
GLYSTHYDON LTD., Nook Farm, Rake Lane, Warton, Preston, Lancs. 0772 633138
MICRODIGITAL, 25 Brunswick Street, Liverpool L2 0BJ. 051 227 2535
MICROPUTE, 7 Westbourne Grove, Manchester M20 8JA. 061 445 8588
MAGNUM CONSULTANTS, 57 Fairburn Drive, Garforth, Leeds. 0532 867892

MIDLANDS

H. B. COMPUTERS, 22 Newland Street, Kettering, Northants. 0536 83922
M&R SYSTEMS, Westgate House, 23 Leverington Road, Wisbech, Cambs. 094571 2741
MIDLAND MICROCOMPUTERS, 1 Cherry Wood Drive, Aspley, Nottingham. 0602 298 281

LONDON and the SOUTH EAST

C.C.S. MICROSALES, 7 The Arcade, Letchworth, Herts. 046 26 73301
MICROBITS, 34b London Road, Blackwater, Camberley, Surrey. 0276 34044
SLOUGH MICROSHOP, 120 High Street, Slough, Berks. 0753 22855
HOME & BUSINESS COMPUTERS, 445 High Street, Manor Park, London E12. 01-472 5107
E. M. G., 30 Heathfield Road, Croydon, Surrey CR0 1E4. 01 688 0088
G. P. W. ELECTRONICS, 146a London Road, North End, Portsmouth, Hants. PO2 9DJ. 0705 693341
INFORMEX LTD., 8-12 Lee Road, London SE13. 01-318 4213
NEWBEAR COMPUTERS STORE, 40 Bartholomew Street, Newbury, Berks. RG14 5LL. 0635 30505
N.I.C., 61 Broad Lane, Tottenham N15. 01-808 0377
TVJ MICROCOMPUTERS, 165 London Road, Camberley, Surrey CU15 3JS. 0276 62506
WOODSTOCK COMPUTER SERVICES, 44 Hopparden Road, Tunbridge, Kent. 0732 355349

WALES and the WEST

CAR RADIO LTD., St. Lawrence Yard, North Hill, Plymouth, Devon. 0752 69097
ELECTROPRINT, 5 Kingsdown Parade, Bristol BS6 5WD. 0272 292375
TRYFAN COMPUTERS, 3 Swifts Buildings, High Street, Bangor, Gwynedd LL57 1UW. 0248 52042
TVJ MICROCOMPUTERS, 48 Gloucester Road, Bristol 0272 422061

Or send coupon for further information to:

SOLE DISTRIBUTORS

Geoff Wilkinson
LIVEPORT DATA PRODUCTS
The Ivory Works, St. Ives, Cornwall.
0736-798157

PLEASE SEND DETAILS OF THE EXIDY RANGE

NAME _____

ADDRESS _____

New Low-Cost ASCII Keyboards Ex Stock Delivery



ALL THE ABOVE KEYBOARDS ARE FULLY TTL-COMPATIBLE PROVIDING THE FULL 128 ASCII CHARACTER SET, AND REQUIRING +5V -12V POWER SUPPLY. FULL TECHNICAL DATA AND CIRCUIT DIAGRAMS SUPPLIED.

Model	Mail Order Total	Optional Extras	Price	Price
KB771 71 Keystations incorporating separate numeric/cursor control pad and installed in a custom built steel enclosure	£95.00	KB15P Edge Connector	£3.25	£4.31
KB756 56-keystations, mounted on PCB	£45.00	KB701 Plastic Enclosure	£12.50	£15.24
KB756MF, as above, fitted with metal mounting frame for extra rigidity	£50.00	KB702 Steel Enclosure	£25.00	£30.48
	£59.23	KB710 Numeric Pad	£8.00	£9.78
		KB2376 Spare ROM		
		Encoder	£12.50	£14.95
		DC-512 DC/DC Converter	£7.50	£9.20
		25-Way D-Type connector for KB771	£4.25	£5.46

All equipment is refurbished second-user equipment unless otherwise stated. All prices subject to carriage & VAT. Trading conditions supplied on request.

BALL MIRATEL VIDEO MONITOR



9in. diagonal P4 phosphor tube. Bandwidth 12MHz (-3dB). Input voltage 220V 50/60Hz 24W. Output voltage +15V DC (short circuit protected) +12kV DC; 12.6V r.m.s. Separate horizontal & vertical sync. Supplied complete with high & low voltage power supplies, amplifier, and attractive moulded plastic housing including space for keyboard. Full technical manual provided.

PRICE: **£95.00**
(total including carriage and VAT £123.00)

NEW SHUGART FLOPPY DISC DRIVES



SA400 Minifloppy — 110KB capacity, 35 tracks, transfer rate 125Kbits/sec AV access time, 550msec. Power requirements +5VDC +12VDC

PRICE: **£195.00**
(price including carriage & VAT £235.00)

SA800 Floppy — 400KB capacity, 77 tracks, transfer rate 250Kbits/sec. AV access time 260msec. Power requirements +24DC +5VDC -5VDC

PRICE: **£395.00**
(price including carriage & VAT £468.00)

DIGITRONICS PAPER TAPE PUNCH



Solenoid-actuated unit capable of punching 5 to 8 channel tapes asynchronously. Basic punch contains 8 data, 1 sprocket and 2 transport solenoids plus end-of-tape switch. Pulse amplitude 27VDC. Very compact unit measuring only 6in. x 8in. x 5½in., weight 9½lbs.

Model P120 (20 cps) **£75.00**
(price including carriage & VAT £92.00)

Model P135 (35 cps) **£95.00**
(price including carriage & VAT £115.00)

TERMI PRINTER 7075

Typewriter-quality Keyboard Send/Receive Impact Printer providing full upper and lower case character set, switch-selectable print speeds of 10, 15 and 30cps, 118-column print line with pin-feed platen suitable for paper rolls or continuous stationery (paper width 12.85in.) Standard V.24 (RS232) Interface



£575.00

ELECTRONIC BROKERS LIMITED

49-53 Pancras Road, London NW1 2QB.
Telephone: 01-837 7781 Telex: 298694.
Our showroom is open MON/FRI 9-1, 2-5 (2 mins. Kings Cross underground)

BOOKS
MAGAZINES
SOFTWARE

L.P. ENTERPRISES

ROOM PW
8/11 CAMBRIDGE HOUSE
CAMBRIDGE ROAD
BARKING
ESSEX IG11 8NT
01-591 6511

Z80 Users

Have you a Z80, or access to one?
Have you seen, read and digested

Leventhals	Z80	Assembly Language Programming	£6.45
Osbornes	Z80	Programming for Logic Design	£6.30
Bardens	Z80	Microcomputer Handbook	£7.50
Wadsworths	Z80	Instruction Handbook	£2.95
and	Z80	Software Gourmet Guide & Cookbook	£7.95

No? Why not?

Here's the chance to fill this gap in your life!

HOW TO ORDER

Send cash, cheque, P.O. or credit card no. to

L.P. ENTERPRISES

ROOM PW 8/11 Cambridge House, Cambridge Road

Barking, Essex IG11 8NT

All payment must be in sterling and drawn against a UK bank

Telephone orders and enquiries welcome 01-591 6511

TRADE ENQUIRIES WELCOME

Some NEW Items

Compute — A super new magazine for the 6502 User. This magazine is at present divided into four sections. These are 1) 6502 section, covering areas of general interest. 2) Business and Industrial, for both learners and 'doers' 3) Education — intended as a resource guide for teachers. 4) The 'Gazettes' — including articles covering specific machines. i.e. the PET, the ATARI, the APPLE and single board computers. '68 Micro — Features articles of interest to the 6800 User: - ranging from software updates to hardware developments, covering such areas as SCOPE (SSB DOS Backspace), LIFE (a 6809 Program), INTEG MOD (Flex Utility), 6809 Adaptor for the 6800 and Data Files.

Compute	Sub £17.50 s.i.	£1.95
68'Micro	Sub £17.50 s.i.	£1.95
Introduction to LOW RESOLUTION GRAPHICS		£5.50
6502 Assembly Language Programming		£6.45
Business With Your Microcomputer		T.B.A.
Running Wild		£2.95
More BASIC Computer Games		£5.50

Thinking Computers?



Then come to the number one micro-computer centre

If you're wondering if a micro-computer can help you, we are here to advise you. At Lion House—London's leading centre for micro-computers—you'll find:

- * Experts who'll explain the equipment in a way you can easily understand, showing how and where it applies to *your* work.

- * Demonstration areas where you can get immediate experience of using micro-computers yourself.

- * Probably the biggest range of software in the UK.

- * Programmes can be tailored for your particular commercial needs by our In-House Analysts and Programmers.

- * Total service—including the availability of full maintenance after you've bought an installation.

- * Leasing and H.P. facilities immediately available.

- * A computer book section with publications that give you new insight into the world of micro-computers.

How will micro-computers help you? In thousands of ways—only a few can be mentioned here...

MICRO-COMPUTERS FOR BUSINESS



For business and professional, the versatility of compact micro-computers means that all the benefits of big computers are made available to all at low cost. The businessman can now computerise his accountancy, his stock control, his records and much more—cutting his overheads and improving his efficiency.

For the home, micro-computers have innumerable uses and considerable value too—sometimes in unexpected ways.

MICRO-COMPUTERS FOR THE HOME



Budgeting... investments... controlling heating or security... storing information on things like recipes... designing complex and fascinating games... education...

Come and see. We invite you to visit us and investigate the possibilities and the potential. If you're too far away, phone or write and we'll send you more information.

You need a micro-computer. We can supply it.



LION MICRO-COMPUTERS

SMALL COMPUTERS—TO MAKE YOUR BUSINESS BIGGER

Lion Computer Shops Ltd, Lion House, 227 Tottenham Court Road, London W1 (First Floor). Telephone: 01-637 1601.

Telex: 28394 Lion G.

Open 9 to 6, Monday to Saturday (Thursday to 7).

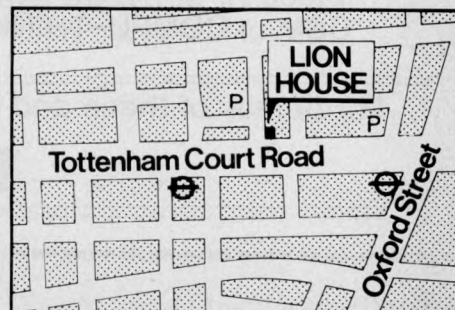

COMPUTERMANIA
PRESENT
COMPUCOLOR II

Includes integral **floppy disc**
and full **colour display**

sensational offer £895



• 13" COLOUR MONITOR for COLOUR GRAPHICS etc
• Built in MINIFLOPPY DRIVE 51.2K per side
• Impressive EXTENDED BASIC on 16K ROM
• HIGH RESOLUTION GRAPHICS 128x128
• RS232C port simplifies PRINTER or MODEM attach.

prices excl. VAT

16K user RAM £895.00
32K user RAM £999.00
PRINTER 9128 £495.00

Computermania (08446) 729 102 WALTON ST OXFORD

Fantastic FREE OFFER!! worth £11!
With all purchases from COMPUTERMANIA

nascom-2 IN STOCK! £295

THE BASIC HANDBOOK
ENCYCLOPEDIA of the BASIC
by Dr. David A. Lien



9K ROM Basic . 8K RAM . IBM type keyboard
Onboard Cassette, TV, Video interfaces
This must be the most powerful and
flexible development kit to hit the
European market
Phone for Computermania's mad offer!

TECS

The most exciting breakthrough
since the chip converts TV
into a Prestel and/or teletext
receiver whilst also providing
a powerful personal computer
(Computermania)
PHONE NOW FOR OUR PRICES

PRINTER IMP

- Serial RS232 interface
- 80 characters wide
- Bidirectional printing
- 60 lines per minute
- 10 line print buffer
- 98 character ASCII set
(includes upper/lower case, 5 # £)

- Automatic CR/LF
- 8 1/2" paper
- Optional tractor feed
- Baud rate from 110 to 3600
- External signal for optional
synchronisation of baud rate

ONLY £325

aculab Ltd

> ACULAB 735, a fully self-contained interface for IBM 735 output golfball typewriters

The ACULAB 735P INTERFACE is a self-contained controller for IBM I/O typewriters and printers. The 735P accepts standard 7-bit parallel ASCII data and provides all of the handshake protocol, code conversion and solenoid voltages to run the printer at full speed using any correspondence or ASCII golfball to produce letter quality printing at 15 chars/sec
... £155.00 + VAT

The TRS-1 PARALLEL PORT DECODER plugs into the bus connector on the TRS-80 keyboard and decodes the port used by the ELECTRIC PENCIL and the LPRINT and LLIST commands in TRS-80 BASIC.
... £55.00 + VAT

The IEEE TO PARALLEL PORT CONVERTER plugs onto the PET IEEE bus connector and converts it into a parallel printer port. It also converts PET's unique version of ASCII to standard ASCII and provides a switch to give UC/LC compatibility with the new PET
... £45.00 + VAT

The ADDRESSABLE IEEE PARALLEL PORT DECODER has all of the features of the converter but may be set to answer to any of the available addresses on the PET IEEE bus and so be used along with the PET disc or any other bus compatible devices
... £66.00 + VAT

These last three devices are all fitted with 2 metres of heavyweight cable and a metal shrouded Centronics compatible connector.

IBM 735 typewriters and 1051 printers are available wired tested and ready to go.

aculab Ltd.

For further information
Telephone. 0525-371393.

24 Heath Road,
Leighton Buzzard, Beds.
LU7 8AB

dam
dams
OFFICE EQUIPMENT LTD.,
30-36, Dale Street,
Liverpool

WE CAN HELP YOU WITH:

STOP PRESS: NOW DEALERS FOR THE ACT 800!

PETS: PRINTERS: DISKS

2001(32K) £715	CBM 3022 £675 inc cable	CBM 3040 £880
2001(16K) £607	ANADEX £650	COMPU { 400K £875
2001(8K) £495	TELETYPE 43 from £889	THINK { 800K £1095

SOFTWARE

PETAID: From Stage One Computers, disk based file handling in hours, not weeks - possibly the most useful piece of software available for PET.
CBM or COMPU-THINK £140

PETACT: Well written business systems covering Sales & Purchase Ledger, Invoicing, and Stock Control: from £270

Many more items in stock

For details of these and many more products and services; telephone:-

051-227-3301

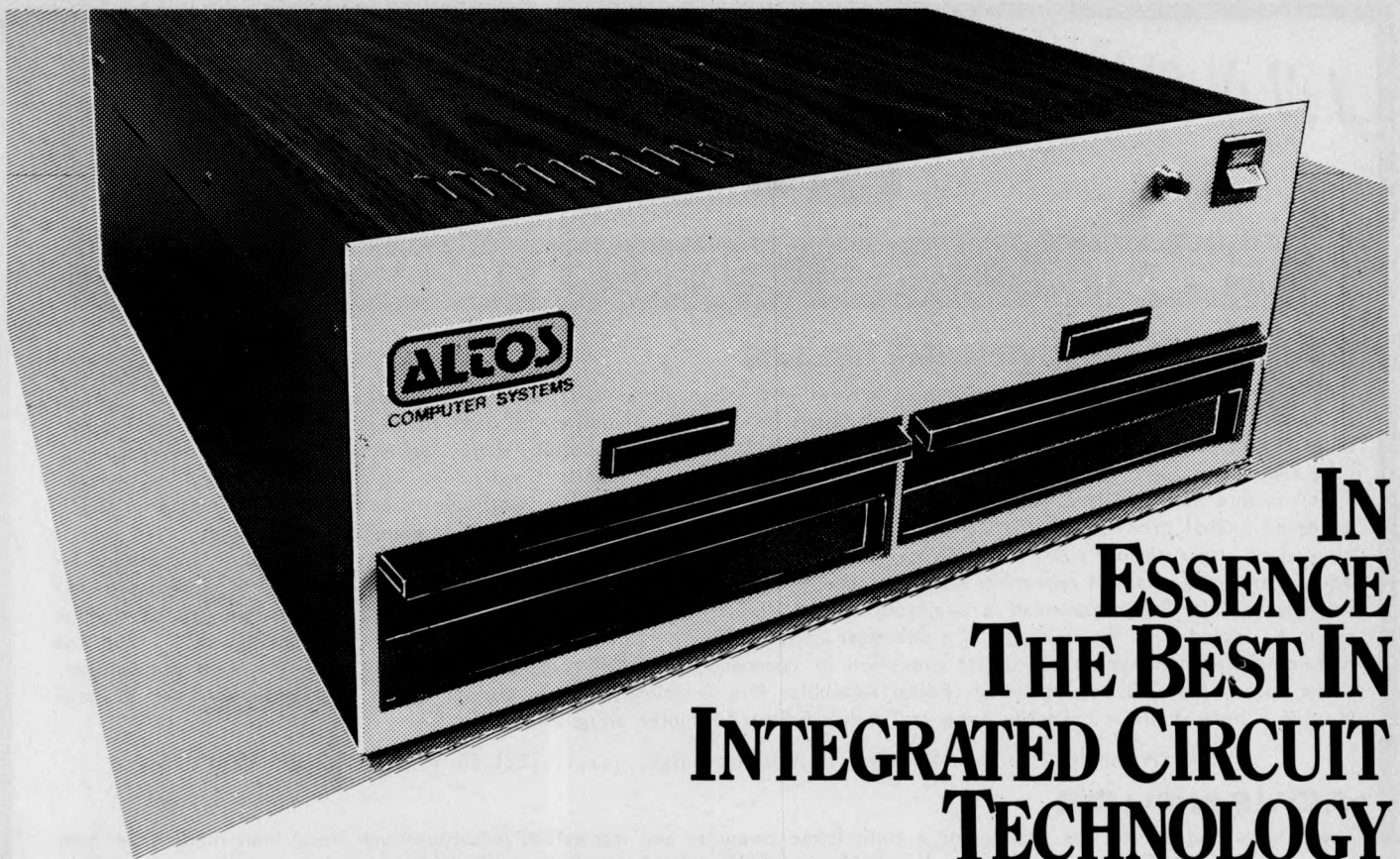

IN ESSENCE THE BEST IN INTEGRATED CIRCUIT TECHNOLOGY

The ALTOS Sun Series ACS 8000 BUSINESS/SCIENTIFIC micro computer creates a new standard in quality and reliability in high technology micro computers.

High Technology

The ACS 8000 is a single board, Z80 disc-based micro computer. It utilises the ultra reliable Shugart 8 inch, IBM compatible, disc drives, double density — single sided, and providing 1 M. byte of data storage. The ACS 8000 features the ultimate in high technology hardware: a fast 4 MHz.Z80CPU,64 kilobytes of 16 K dynamic RAM, 1 kilobyte of 2708 EPROM, an AMD 9511 floating point processor (OPTIONAL) a Western Digital floppy disc controller, a Z80 direct memory access (OPTIONAL), Z80 parallel and serial I/O (two serial RS232 ports, 1 parallel port), and a Z80 CTC Programmable Counter/Timer (real time clock). In essence, the best in integrated circuit technology.

Built-in Reliability

The ACS 8000 is a true single board micro computer. This makes it extremely reliable and maintainable. The board and two Shugart drives are easily accessible and can be removed in less than ten minutes. All electronics are socketed for quick replacement. Complete diagnostic utility software for drives and memory is provided.

Quality Software

Unlimited versatility. The ACS 8000 supports the widely accepted CP/M disc operating system plus basic (Microsoft and CBasic), Cobol, Pascal, and Fortran IV. All available now.

Logitek in conjunction with its own microsoftware house, Interface Software Ltd. of Camberley is able to supply a wide range of proven 'off the shelf' business software including general accounting, word processing, stock control, mailing list etc.

There are already over 1000 micro computer installations using this software.

A track record which we consider speaks for itself.

Why 're-invent the wheel' when there is standard software of this quality available now?



Hard Disk/ Multi User Systems

The Winchester hard disk, single and multi user ALTOS systems are now available, supporting from 1 to 4 users and providing up to 58 Megabytes of data storage capacity. The systems are truly flexible and allow the ALTOS floppy disc system to be expanded to keep pace with the users requirements.

Availability

Logitek carry deep shelf stocks of ALTOS hardware and compatible peripherals.

If you are a dealer who may be interested in promoting ALTOS and/or Interface Software by joining the fast growing network of approved suppliers, contact Logitek.

We can offer you something rather special now.

Approved Dealers

LONDON

Logic Box Ltd.
Tel: (01) 222 1122

Boyd Microsystems
(Watford)
Tel: (01) 950 0303

GLASGOW

Robox
Tel: (041) 221 5401

Aethotrol Consultancy Services
Tel: (041) 641 7758

BIRMINGHAM

Saba Computer Systems
Tel: (021) 643 2021

University of Birmingham
(Tony Clewett)
Tel: (021) 472 1301
ext. 2001/2273

SHEFFIELD

Sheffield Computer Centre
Tel: (0742) 53519

GLOUCESTERSHIRE

Woolsack Computer Centre (Tetbury)
Tel: (06666) 269

DARLINGTON

Vane Consultants
Tel: (0325) 67766

WILTSHIRE

Validata Services (Melksham)
Tel: (0225) 705957

BOLTON

B. & B. Consultants
Tel: (0204) 26644

PERTH

Peter Macnaughton & Associates
Glenalmond
Tel: (073 888) 267



Logitek
E.I.C. Electronics Ltd.
All enquiries to:
Portland St., Chorley, Lancs.
Tel 02572 66803

also at:
30 Kelvin Ave.,
Hillington Industrial Estate,
Glasgow G52 4LH
Telex: 777255

INNOVATIVE TRS-80 SOFTWARE

FROM THE PROFESSIONALS

EDITOR/ASSEMBLER PLUS

Now get every feature of Tandy's Editor Assembler and T-Bug all in one package. PLUS - many "big computer" features to simplify your programming, editing and debugging. Its no longer necessary to waste time creating both source and object tapes - Assembler Plus assembles directly into memory. Macros are supported, simply define a Macro and any frequently used sequencies are automatically assembled. Assembler Plus also supports Conditional Assembly with 2 new pseudo ops, which enable assembly if a condition is true. There are 7 new expressions available, together with an automatic ORG, improved symbol print out and a Quash command to give you more storage space for general text editing. And that is all just on the Assembly side! The Editor is improved with extra commands like Substitute, Move, Copy and Extend for moving entire blocks and repeating them anywhere in the file, and for searching and substituting occurrences in old text for new text. A Range command is available for both Edit and Find enabling you to operate on a single line or a range of lines. Included in the package is a debugger called Z-Bug which includes all of the features of Tandy's T-Bug and features single step execution, direct execution in command mode and symbolic references, plus up to 8 breakpoints, rather than the single one in T-Bug. Editor/Assembler Plus is written by the original author and comes with an 80 page Manual - best of all it costs the same as Tandy's Editor/Assembler alone!

Editor/Assembler Plus for 16K Level II. Cassette based.....£21.70 + VAT = £24.95 50p P & P

ADVENTURE

The original Adventure was written for a main frame computer and was called Adventureland. Since then there have been many derivatives. The best are written in machine code like the Scott Adams series (for which label we happen to be the sole importers!) but good as they are, they have had to be shortened to fit into 16K. This Microsoft Adventure is the original uncut main frame version, for the first time available for a microcomputer. Once you enter the Colossal Cave, your journey takes you through a labyrinth of caves containing active volcanoes, green snakes, sulfur lakes, killer dwarves, trolls, five foot oysters and many many more surprises before you can collect the 25 Treasures and be a Grand Master! All the while directing your journey with commands and questions to the computer in English. Over 400 messages and descriptions are combined in an endless number of ways in the program vocabulary. Almost literally mind blowing!

Adventure. 32K single drive minimum. Disk based£19.50 + VAT = £22.43 50p P & P

ASSEMBLY LANGUAGE PACKAGE

A Complete Assembly Language package for the user who requires the ultimate in programming aids. This package consists of a Macro Assembler, a Linking Loader, a Text Editor and a Cross Reference Facility. The Macro Assembler accepts Z-80 opcodes and supports a complete Intel standard macro facility including IRP, IRPC, Repeat, local variables and ExitM. The code is assembled in relocatable modules which offer the advantages of easier coding, faster testing, debugging and modifying. An expanded set of conditional pseudo ops allows testing of assembly pass, symbol definition and parameters to macros. Other assembler features include comment blocks, octal or hex listings, titles and subtitles, variable input radix (base 2 to 16) and a complete set of listing controls. The Linking Loader provides a number of loader capabilities executed by means of easy command lines and switches. Any number of programs may be loaded in user specified locations. Internal and external references between modules are resolved automatically. The Loader also performs library searches for system subroutines and generates a load map of memory showing the locations. The Text Editor is a random access line orientated text editor similar to those used on the IBM 360 and PDP-10 computers. The Editor's speed and simplicity make it easy to insert, replace, print or delete lines; edit individual lines; renumber lines in a file and to find or substitute specified text. The Cross Reference Facility provides a convenient alphabetical list of all program variable names, together with the line numbers where they are referenced and defined.

Assembly Language Package. 32K single drive minimum.....£65.00 + VAT = £74.75 50p P & P

FORTRAN

The best Fortran Language Compiler available for the TRS-80 - a standard ANSI Fortran from Microsoft. The package includes the Compiler, a Linking Loader, a Text Editor and a Fortran Runtime Library. The Compiler has a number of enhancements to the ANSI standard: LOGICAL variables which can be used as integer quantities, +127 to -128; LOGICAL DO loops for tighter, faster execution of small valued integer loops; mixed mode arithmetic; hexadecimal constants; Literals and Holleriths allowed in expressions; logical operations on integer data AND..OR..NOT..XOR can be used for 8 or 16 bit Boolean operations; READ/WRITE End of File or Error Condition transfer, that is, control may be transferred to a specified statement on end of file or error encounter; Encode/Decode for Format operations to memory. The standard library supplied includes 49 subroutines, together with routines for 32 bit and 64 bit floating point functions. Users may write non-standard I/O drivers for each Logical Unit Number - making the task of interfacing non standard devices to Fortran, a straightforward one.

Fortran Package. 32K single drive minimum£65.00 + VAT = £74.75 50p P & P

Send large SAE (27p) for our current Catalogue of TRS-80 Software. Add £1.45 for a binder.

A.J.HARDING (MOLIMERX)

28 COLLINGTON AVENUE, BEXHILL-ON-SEA, E.SUSSEX. TEL: (0424) 220391

TELEX 86736 SOTEX G FOR A. J. HARDING



OUR SYSTEMS CAN GROW ON YOU

When you buy one of our low price microcomputer development systems you not only get a fully burnt-in and tested system designed and manufactured to industrial standards. You also get access to an ever-increasing range of software tools. And if you require a VDU or printer now or later, there is a selection of these and other peripherals from which to choose. So your system can grow and grow.

Our systems start to grow on you at £1450. This buys you a 32KB system with dual 5¼ inch double density floppy drives. At £1675 you can have a 48KB system or for £2495 one with the extra memory storage provided by dual 8 inch double density floppy drives. All the systems are based on the powerful Z80 microprocessor and S100 bus structure and can provide memory management. Cartridge disc drives are available providing up to 40MB of storage.

The prices include an operating system and language, in this case CP/M and C-BASIC, to

give a typical system cost. But with slight cost adjustment the software options are:

Operating Systems

- CP/M ● PASCAL ● CAP MICROCOBOL BOS
- Multi-User, Multi-Tasking Operating Systems

Languages

- C-BASIC COMPILER ● M-BASIC ● FORTRAN-80
- COBOL-80 ● PASCAL ● CIS-COBOL

There is also a word and text processing system available that is ideal for report writing.

You simply take your pick from the software options. Or visit our London showroom and see the systems demonstrated.

SYSTEMS
WITH CP/M AND
C-BASIC:

32KB + Dual 5¼ inch Floppies: **£1450**

48KB + Dual 5¼ inch Floppies: **£1675**

48KB + Dual 8 inch Floppies: **£2495**

Prices exclude VAT.

Nationwide maintenance facilities available.

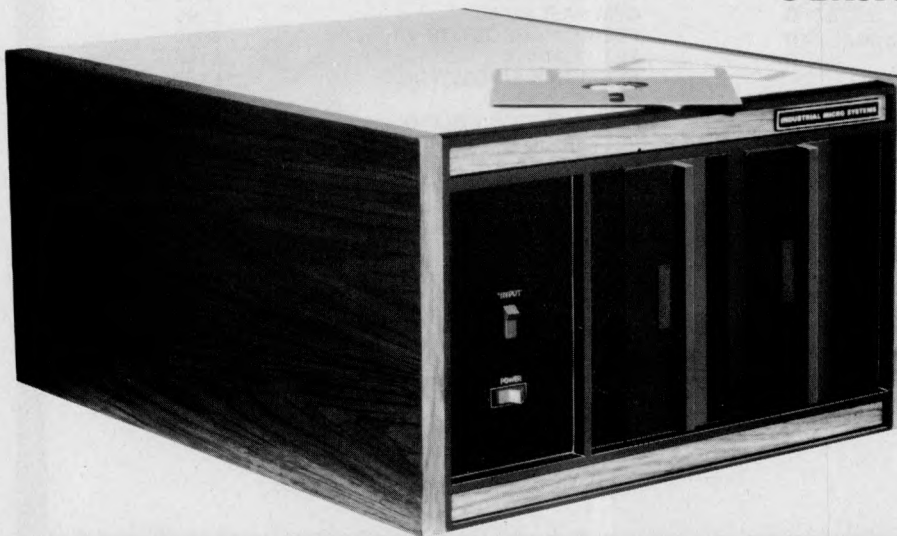

EQUINOX

COMPUTER SYSTEMS LTD.

Kleeman House, 16 Anning Street,
New Inn Yard, London EC2A 3HB
Tel: 01-739 2387/9 & 01-729 4460

*New! Produced in the UK and widely used here and in the USA –
COMPLETE BUSINESS PACKAGE*

**INCLUDES EVERYTHING FROM INVENTORY TO SALES SUMMARY
PROMPTS USER, VALIDATES EACH ENTRY, MENU DRIVEN**

Approximately 60-100 entries/inputs require only 2-4hours weekly and your entire business is under control

PROGRAMS ARE INTEGRATED

01 = ENTER NAMES/ADDRESS, ETC
02 = *ENTER /PRINT INVOICES
03 = *ENTER PURCHASES
04 = *ENTER A/C RECEIVABLES
05 = *ENTER A/C PAYABLES
06 = ENTER/UPDATE INVENTORY
07 = ENTER/UPDATE ORDERS
08 = ENTER/UPDATE BANKS
09 = EXAMINE/MONITOR SALES LEDGER
10 = EXAMINE/MONITOR PURCHASE LEDGER
11 = EXAMINE/MONITOR (INCOMPLETE RECORDS)
12 = EXAMINE PRODUCT SALES

SELECT FUNCTION BY NUMBER

13 = PRINT CUSTOMER STATEMENTS
14 = PRINT SUPPLIER STATEMENTS
15 = PRINT AGENT STATEMENTS
16 = PRINT TAX STATEMENTS
17 = PRINT WEEK/MONTH SALES
18 = PRINT WEEK/MONTH PURCHASES
19 = PRINT YEAR AUDIT
20 = PRINT PROFIT/LOSS ACCOUNT
21 = UPDATE END MONTH FILES MAINTENANCE
22 = PRINT CASH FLOW FORECAST
23 = ENTER/UPDATE PAYROLL (NOT YET AVAILABLE)
24 = RETURN TO BASIC

WHICH ONE? (ENTER 1-24)

01 SUB. MENU EXAMPLE: 01 = EXAMINE: 02 = INSERT: 03 = AMEND: 04 = DELETE
05 = PRINT (1,2,3): 06 = NUMERIC COMBINATIONS: 07 = SORT

ALLOW ONE DISK . VERY FLEXIBLE . ADD YOUR OWN FUNCTIONS . EASY TO INTEGRATE . SINGLE REY PROMPTS

All programs in BASIC for CP/M . PET . 6800

G. W. COMPUTERS LTD the producers of this beautiful package

We export to all countries: Callers by appointment only:

Contact Tony Winter. Tel: 01-636 8210

G. W. COMPUTERS LTD

89 Bedford Court Mansions, Bedford Avenue, London WC1

IMPORTANT! We also sell the hardware to do the above tasks so you can purchase the entire package from one source.

.PET.PET.PET.PET.PET.PET.PET.PET.PET.PET

PET COMPUTER 32K	£795.00
PET Floppy Disc	£795.00
PET Printer T/Feed	£645.00
PET Cables	£45.00
PAPER	£28.50
10 Diskettes	£28.50
1 year software support	£50.00
	£2387.00

.SUPERBRAIN.SUPERBRAIN.SUPERBRAIN.SUPER

Twin Floppy D/Density 5¼	£1950
--------------------------	-------

.SPECIALS.SPECIALS.SPECIALS.SPECIALS.SPECI

48K Industrial Microsystems and Twin D/Drives 5¼	£2000
Intertube Video Terminals	£495
40K SWTP 6800 & Twin; S/Density 5¼" Drives	£1000

.PRINTER OPTIONS.PRINTER OPTIONS.PRINTER

a) Paper Tiger	195 cps	£685
b) Texas 810	150 cps	£1495
c) Teletype 43	30 cps	£895
d) DEC LA34	30 cps	£895
e) OUME Daisywheel	45 cps	£2450
f) NEC Sprinwriter	65 cps	£1950

.SOFTWARE.SOFTWARE.SOFTWARE.SOFTWARE.

CPM MBASIC-80	£156
CPM FORTRAN-80	£200
CPM COBOL 80	£320
CPM WORD STAR	£250
CPM SUPER SORT	£20
CPM BSTAM	£75
CPM DESPOOL	£30
CPM PASCAL M	£200
PET COMACCOUNTS	£650
PET COMPAY	£150
PET COMBIS/COMSTOCK	£150
PET WORDPRO	£75
PET SUPER COMWORD	£150
PET MASTER LIBRARY	various

Walkie Talkie Telephone (freedom Phone)
Connects to normal telephone make. or take calls
300ft from home. £195 (not P.O. Approved)

Telephone Answering Machine. Recall Message
anywhere in World £195 (not P.O. Approved)

Call for Special All-in Deal Offers

Warranty includes free replacement of equipment
within 90 days if found defective

SUPERBRAIN Dealer enquiry invited

We export to all countries: Callers by appointment only:

Contact Tony Winter. Tel: 01-636 8210

G. W. COMPUTERS LTD

89 Bedford Court Mansions, Bedford Avenue, London WC1

TAKE CONTROL



Advanced interfacing for micro-mainframe connection, control instrumentation and communications for the microcomputer user.

We have interfacing experience with

Mainframes

IBM, ICL, Univac, Honeywell, DEC, Harris, Etc.

Instrumentation

Strain Gauges, Gas Chromatographs, Chart Recorders, Auto Analysers, Digital Oscilloscopes, Thermocouples, Accelerometers, Etc.

Peripherals

Punches, Readers, Discs, Tapes, Plotters, Bar Codes, Etc.

For further information please contact **Graham Knott** or **Jeff Orr** on **051-933 5511**

Stack Computer Services

290/298 Derby Road, Bootle, Liverpool 20.



TANGERINE

COMPUTER SYSTEMS LIMITED

microtan 65

Small enough to learn with
Big enough to work with!

£69
plus VAT

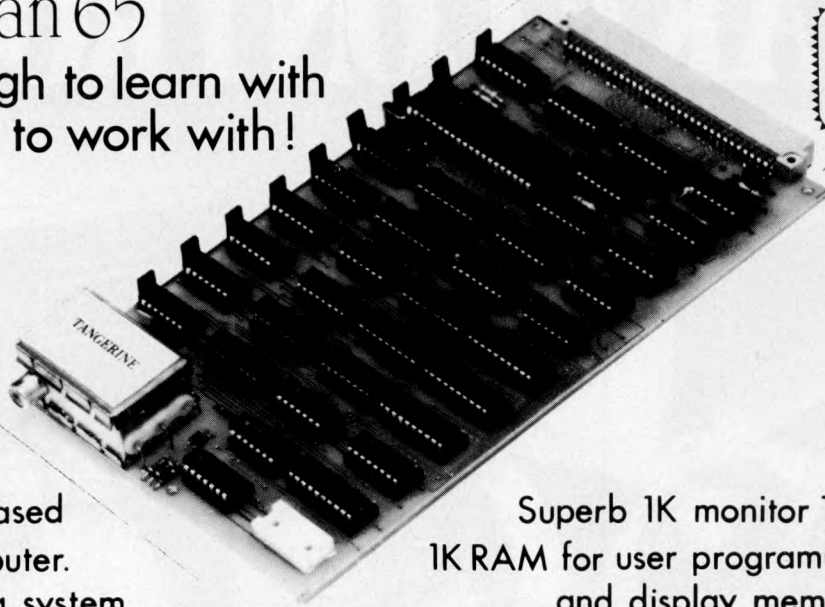

A 6502 based
microcomputer.

Expands into a system.

VDU alphanumeric display on un-modified domestic TV of 16 by 32 characters.
Optional lower case pack making a total of 128 displayable characters.
Optional chunky graphics pack (64x64 pixels) ● Excellent documentation.

MICROTAN 65 outperforms all other small microcomputers in terms of value for money and performance. It is much easier to use as a result of the video display, intelligent keyboard socket, and very powerful monitor. The system grows to become a very useful, complete microcomputer in sensibly priced and very well designed modules. Each module is superbly packaged and with comprehensive hardware and software documentation. The Microtan users manual is A4 size, 136 pages thick, and comes beautifully bound.

TANBUG is probably the most powerful 1K monitor available. Apart from bringing the hardware alive it really does serve the purpose of programme debugging. TANBUG offers memory and register examine, modify and list, block moves, single instruction, multiple non-destructive breakpoints with ability for multiple passes, address offset calculation and many other useful features. MICROTAN 65- More power for your money!

Superb 1K monitor TANBUG
1K RAM for user programme, stack
and display memory.

The TANEX expansion board opens the door to a full system as well as including an abundance of features. In its minimum configuration TANEX is supplied with 1K RAM, 16 parallel I/O lines, TTL serial I/O port, cassette interface, 2x16 bit counter timers, memory mapping, data bus buffering, and is fully socketed. When fully expanded TANEX offers all of the above plus a further 6K RAM, 6K ROM, 8K MICROSOFT BASIC, a further 16 parallel I/O lines, 2 counter timers and TTL serial I/O port, and a third serial I/O port with RS232/20mA, full modem control and 16 different baud rates. Check the price list below to see how cheap it is to fully expand the system.

20 Way keypad- plugs into the intelligent keyboard socket and gets you going without the expense of a full ASCII keyboard. Keyboard socket will accept any ASCII keyboard.

Mini-mother board, comes complete with connectors and reset switch.

ORDER FORM:

Qty. Microtan 65 Kit	£79.35
Qty. Microtan 65 Assembled	£90.85
Qty. Tanex (min.con) Kit	£49.45
Qty. Tanex Assembled	£60.95
Qty. Lower case pack	£10.90
Qty. Chunky Graphics pack	£ 7.50
Qty. 20 Way Keypad	£ 8.95
Qty. Mini-mother board	£ 9.95

ALL PRICES INCLUDE VAT. Add £ 1.50 P&P Please.

EXPANSION COMPONENTS:

Qty. Serial I/O Kit	£14.80	6552	£ 9.20
Qty. 2716(5V type)	£28.75	2114	£ 4.80

NAME: _____

ADDRESS: _____

BROCHURE AVAILABLE ON REQUEST PLEASE SEND 10p.
TANGERINE COMPUTER SYSTEMS LTD.
FOREHILL, ELY, CAMBS. Tel: (0353) 3633.

TANGERINE

COMPUTER SYSTEMS LIMITED

SUGGESTION FOR MARCH P.C.W.

HOW ABOUT:

A PAPER ELEPHANT
COULDN'T FORGET
TO ASK FOR
KINGSTON ???

No - Paper elephants
have no brains

PRECISELY !!!

Forget it !! Just type set
the offers, they speak
for themselves !!!

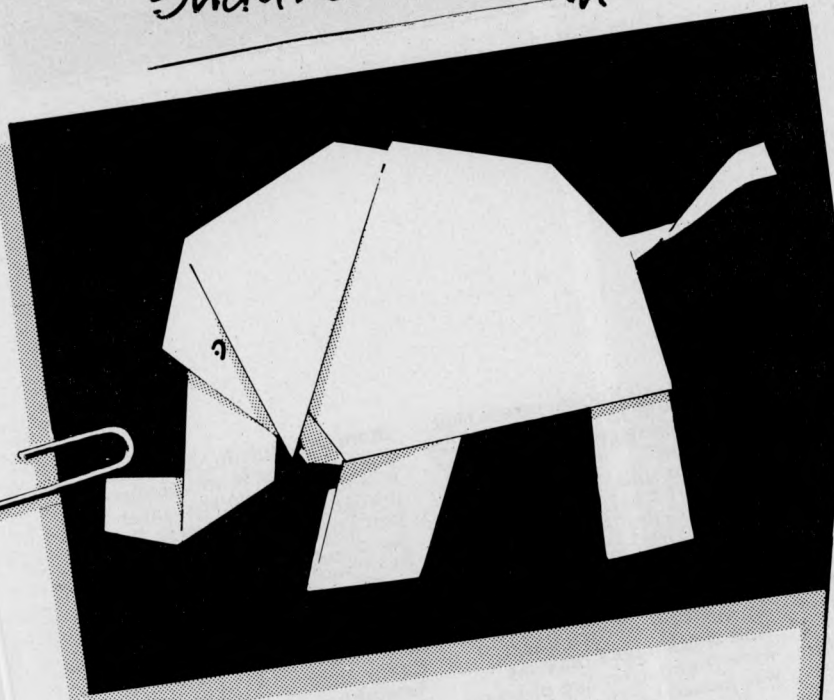

COMPUTHINK

400K Random access disc drive for the 8K PET. PLUS 32K Expandamem memory expansion board.
LIST PRICE £1115.00 **OUR PRICE £835.00**

KINGSTON: KRK-1

Hardware Repeat Keys for all models of PET. Fitted in two minutes - Do not interfere with any other function - Can speed up programming by 25%. PLUS New Rapid Cursor Programme.
Basic number and cursor pad unit **£17.50**

KINGSTON: TNW/K-2000

The well known TNW-2000 bidirectional IEEE 488/RS232 interface in a new durable KINGSTON steel case.
Despite improvements still only **£135.00**

CMC: ADA-1200

Still a few special price units left of the ADA-1200 unidirectional IEEE 488/RS232 interface
LIST PRICE £85.00 **OUR PRICE £65.00**

CMC: ADA-1400

A new addressable unidirectional IEEE 488/RS232 interface, which we hope will outdistance its predecessor, the ADA-1200, now moving into its three thousandth U.K. sale. **£90.00**

CMC: PETSET/APPLESET

At last the relatively inexperienced PET and APPLE owner can tackle 16 channels of analogue input with nothing more than a screwdriver. **£135.00**

KINGSTON: TNW/K-3000

The first KINGSTON rework of the TNW-232. A biported bidirectional IEEE 488/RS232 interface, which is intended for the user who demands a lot from this equipment.

NOTES

1. ALL KINGSTON products carry a full ONE YEAR guarantee PLUS fixed price 'return to factory' Maintenance/Service Agreement, which offers a ninety day second guarantee after each repair.
2. We will supply dealers with a sample unit on a full price C.W.O. basis. However any follow up orders will be discounted/credited, as if the initial sample were a part thereof.
3. All cheques, money orders etc., should be made payable to 'KINGSTON COMPUTERS LTD'.

OFFER

NEW PRODUCT

IMPROVED PRODUCT

OFFER

NEW PRODUCT

NEW PRODUCT

NEW PRODUCT

OK?

Fine - Now, get rid of that
elephant. It's bringing on
my hay fever.



PCW 31

KINGSTON COMPUTERS LTD., Scarborough House, Scarborough Road, Bridlington
Telex 52642 Telephone 0262 73036
A MEMBER OF THE DALE GROUP OF COMPANIES

Newsprint is the place where Guy Kewney reports the happenings of the micro world — read on for product news, rumour, gossip, prediction, speculation and fearless exposés.



Cobol up on Tandy

People who do not work with computers tend to dismiss as cynics, those who say: "the one thing you can be sure of in talking about software is that it will have mistakes in it". It is, however, a simple statement of observable fact.

That fact always causes a sinking feeling when a particularly ambitious piece of software is announced: I have to pass on the claims of the vendors with no real idea of how well they have been achieved, but with the certainty that there are serious flaws which will only reveal themselves after many hours use of the program.

This heart searching is prompted by the release of a Cobol compiler from Microsoft, for the Tandy TRS-80.

The best microprocessor Cobol is, without any real doubt, that produced in this country by Paul O'Grady's

Micro Focus. It has been tested by American Navy and Government departments who have put it through the most gruelling tests they know of — and it has come through with flying colours, in a way that no other microprocessor Cobol has done.

Yet the tests that the Americans run to prove that Cobol reaches American National Standards Institute level are themselves software. They have flaws. . . some are trivial, errors which a little thought allows the user (the tester) to make suitable compensation, others are disastrous failures of anticipation by the people who devised the tests.

In essence, the tests consist of a long (two million bytes) string of Cobol instructions, some of which are deliberately faulty, some of which are deliberately tricky and some of which generate deliberately large amounts of code that need careful managing. The idea is, these programs are designed

to trap all known errors that can occur in Cobol compilers. The important word here is "known".

I am told, by people whom I trust, that the Micro Focus Cobol is now a very good Cobol compiler indeed. The same people assure me that this is because several major "bugs" have been cleaned out of the code. And these bugs I may say were found *after* the program was passed by the Americans.

Microsoft, the company that produced the standard BASIC interpreter for micros, has now adapted that BASIC to run on the TRS-80 model II, as a compiler. It has also adapted its Cobol compiler to run on the same machine.

And it has announced a program which does the work of three Tandy programs which is designed to assist the user who writes assembly mnemonics for machine code, rather than high level Cobol or BASIC statements. The Cobol is described as an ANSI-74 implementation featuring complete interactive screen handling capability using ACCEPT and DISPLAY; indexed and relative files, and an optional packed decimal format that significantly "reduces mass storage requirements". (More significantly that happens to be a feature of IBM Cobol, so it should make it easier to borrow IBM Cobol programs.) It includes advanced data manipulation verbs (COMPUTE? INSPECT STRING UNSTRING SEARCH), three dimensional arrays, and a full COPY facility.

The BASIC compiler generates machine code from your favourite BASIC programs. The advantage is that when you load and run this machine code, it goes between three and ten times faster than the original BASIC statements can be processed by an interpreter — also it can be loaded onto a machine that doesn't have an interpreter. The drawback is that even at three to ten times faster than interpreted statements, BASIC programs are abominably slow, and Microsoft's claim that the machine code is "highly optimised" has to be taken in that context. Highly optimised *for BASIC*.

The other snag is that if

there is a fault in your program, finding it and changing it is not the snip that interpreted BASIC makes it. But you knew that anyway, and besides, your programs don't have faults.

The assembler mnemonic package is the Editor/Assembler Plus. "In addition to providing every feature of Radio Shack's Editor/Assembler and T-Bug in one package, this cassette based software has features previously available only on large computers, to make working in assembly language easier and faster", says Microsoft. Major new assembler features are listed as "the ability to assemble directly into memory; conditional assembly (you only assemble a section of code if an indicator is set, allowing you to generate different versions of a program) and macro assembly, where a whole sequence of machine code instructions can be generated by one mnemonic.

In America, the Cobol costs \$750, the BASIC costs \$395, and the Ed/Ass costs \$30. BASIC and Ed/Ass will run on the Level I Tandy.

Prestel meets Appletel

Very sensibly, the Post Office is letting Apple II owners use the machine to call up pages from its Prestel data banks. And very sensibly, Apple II distributor Microsense has decided to distribute a product, made by Owl Computers, which will allow the machine to do the job of calling up these pages.

The product is called Appletel, and costs £595. For that money the buyer gets a communications circuit card, modified to Prestel standards; a master disc holding the software and instructions to the owner; and a protective lead to link the Apple II to the Post Office modem, (to protect the Post Office lines, not the Apple) — plus a manual to explain it all.

The user will also need a modem. A modem is a device that turns dots and dashes of binary code into beeps and bleeps of frequency modulated sound — different notes, if you prefer. A Post Office modem is rather a

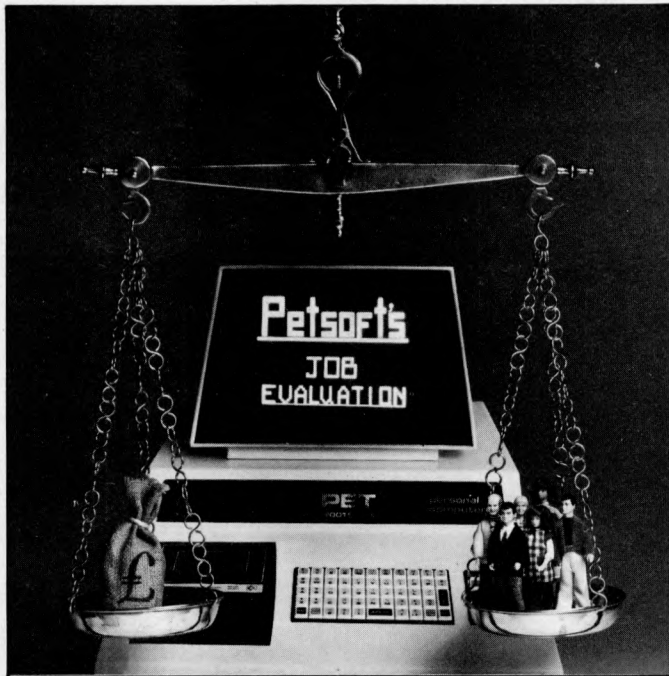

Nobody can say Julian Allason hasn't responded brilliantly to our suggestion that some of the photographs sent in have been more like illustrations of sexual fantasies than a guide to the product on offer. How about this, showing what a £25 job evaluation program for PET is meant to do? It's intended for the company that doesn't know what to offer for a new job inside it: the computer asks questions designed to establish what the management really expect from the new employee, and from that it works out a reasonable salary level. Details on 021 455 8585.

different beast from a Prestel modem, and as things stand today, I don't know of anybody who will sell a Prestel modem.

Mike Gardner of Owl Computers: "will be pleased to talk about the system in more detail," on 0279 52682 and Microsense in Hemel Hempstead will provide details of local dealers.

First the good news...

Terry Brown (I read) is, at 15, one of the younger members of the South East London microcomputer club, SELMIC, which meets regularly at the Thames Poly in Woolwich. A year ago, knowing nothing about micros, Terry was given a computer kit — the Nascom 1 — as a birthday present. Within four days, with a little help from his friends, Terry got the computer built and working; soon he became involved in programming. After "much dedication and study" he sold his first program, making enough money to buy 40 blank cassettes, and making enough of a splash to be offered stand space at the Online Micro Show in July.

There, Terry sold even more programs, and met the marketing boss of Nascom, Kerr Borland. Kerr now hopes to make Terry's future products into "stars" by marketing them worldwide. South East London Software, a small software business, is Terry Brown's latest venture and he's recently built a Nascom 2, financed entirely from his business success in the last year.

The afore piece of news came direct from Selmic. I didn't have to include it, but it owes its reproduction here to two things. First, if the many clubs around the country want the world to know what they are doing, little reports like this (showing what can be done by stating simply what has been done) are invaluable, and I want to hear more.

Second, it gives me "a platform of nice things about Nascom" on which to stand while I mention the unfortunate lawsuit between Nascom and Mine of Information.

From where I sit, it's hard not to sympathise with both parties. Richard Ross-Langley of MoI, like many who wanted to do things with the Nascom 1, got caught in the touch-and-go early delays as the company juggled a revolutionary product with tight finances, amid astonishing sales; his plans to develop software on the machine were scuppered.

Whether this was the fault of Nascom for being disorganised, or of MoI for relying on the guesswork predictions of an overloaded new

company, or again, whether it was just plain bad luck that Ross-Langley, instead of plumping for the 32K byte memory board backed the 8K byte (which never quite got debugged) isn't really the point.

The thing is that lawsuits are bad guides to events — and the events that precede them are often even worse guides to reality. Reality is that companies will get clobbered by angry users and the sound of fists hitting faces will be reported here much more often than the sound of Terry Brown's successful business. Similarly as long as dealers and distributors pretend machines have no faults, those faults will cause rage and disappointment to buyers. It's important to add though that this rage and disappointment is only what *can* happen — not necessarily what *will* happen.

Course notes

PCW's very own book reviewer, Malcolm Peltu, has long been conducting a determined campaign to make human beings pay serious attention to computer technology, and not just run around shouting "Gee Whizz!" while Rome burns.

He will give a two day residential course, costing a miserly £15 (including all meals) at Holly Royde College in April, starting on Friday 18, and finishing on the Saturday.

His subject will be "the social impact of micro electronics" and the organisers at the department of extra mural studies for the University of Manchester, promise that he will show how this technology relates to real world environments, rather than rabbiting on about the number of transistors that can sit on the head of a pin. Enquiries to Mrs L Palethorpe at the Department, Manchester M13 9PL. Phone 061 273 3333.

Post Office taps in Wedge

Want a microcomputer? Ask the Post Office because that corporation is now renting microcomputers to customers of its computer bureau, NDPS (National Data Processing Service).

It's hard to see this information going down quietly in the computing business, even though the first PO steps are small, timid, and have been kept particularly quiet. Too many people will see it as the thin end of a very thick wedge.

The micro business will be delighted, of course. The Post Office is currently buying close to 80% of the production of Casu microcomputers — this being a UK-built micro based on the Z80 chip, using



Dust covers for terminals are available from Data Efficiency (as shown) and South Coast Enterprises of Anaheim, California. DE is on 0442 57137; South Coast on (714) 630 3940.

the standard micro skeleton and the S100 bus. And it's providing these — or most of these — to existing customers of the bureau. What a badge of respectability for the personal computer people!

Think, however, of the people who are chewing their nails. Taking politicians first, nobody can seriously claim it to be coincidence that the NDPS, having lost a packet when its computer staff went on strike last year, has now started supplying machines that will not be affected by any future strikes. It may be only prudence — taking some eggs out of the basket and spreading them around — but no labour organiser worth his salary will let the move go unchallenged, since it strikes (sorry) at one of the most promising new industrial muscles unions have found.

Computer retailers next: can they seriously hope to compete with the country-wide Post Office personnel network? At present, all maintenance of Casu systems is the job of Casu, not the PO. For the future, it need only be said that Casu is small, and plans to stay that way; from that, one deduces that other machines will have to be added, and central maintenance introduced.

In the end, even if the PO does not abuse its monopoly position in telecommunications, its sheer size and staff abilities will make it a good bet for biggest micro rental outfit.

After politicians and retailers; bureaux. These people started off the way the PO bureau did — as a side-line operation for companies which wanted their own computers, but didn't have enough work (or money) to justify the move internally. So they sold off spare time to outsiders, sometimes at a profit. All bureaux are now looking the same way as the Post Office in terms of how they expand. More and more are offering a stand alone machine to sit in the user's own premises, for the cost of the software they run on the

bureau's central machine already. Few have been so radical as to move into microcomputers, and fewer still have gone as far as NDPS which will actually stop all payroll bureau services at the end of this financial year — in April 1980.

One of the most admirably sensible and public spirited policies of that normally predatory outfit, IBM, is its insistence that no supplier of goods or services provides IBM with more than 40% of that supplier's output. The Post Office has no such scruples, and in fact does the opposite; equipment supplied to the PO is normally not permitted for sale to anyone else. The terrible effect on companies like Plessey and STC, as the PO switches from electro-mechanical exchanges to computerised ones, is well documented. In micros, it has taken the sensible approach of using standard products, so far. Within five years, I'll bet anybody that the Official PO Micro is an exclusive design, good at transmitting or storing messages, and inside which thou shalt not stick thy British Standard Finger. It may all be for the best, but until that is proved we will all live in interesting times.

Z80 gets real database?

Theoretically, it makes a great deal of sense to keep all your computer records in one, enormous, automatically house-kept "database" — with all the customer names in alphabetical order, all the account numbers in numerical order, all the important people in priority order, all the tax fiddles in secrecy order, and all the prices in profitability order. Theoretically, this is possible on a big mainframe computer with a database management system, in a package costing upwards of £30,000.

A new piece of software which theoretically allows all

the apparent benefits of this expensive old software, has been announced by an American company, Micro Data Base Systems of Lafayette, Indiana.

The MDBS product runs on the Zilog Z80 micro, and will shortly be available, on other major central processor chips.

It was launched at an introductory cost of \$750, with the promise of hefty price rises: unfortunately the announcement didn't get here until the day before the price rises were to go into effect, and accordingly the marketing coup of a cut-price introduction has been ever so slightly "blown". MDBS has enclosed its apologies, and when I think of something useful to do with them I'll do it!

Meanwhile it's worth recording my total belief that database software is what all micro users of the future are really waiting for. When a good, working foolproof database package hits the market, everybody will want one. "While large mainframe and minicomputer systems have available, sophisticated, data base management tools", says Lafayette blandly, "microcomputers have usually been limited to some variant of an indexed sequential access method file management package".

It's not fair to speak slightly of a new software product before talking to users. It remains unavoidable that if this system does what is claimed to be possible on mainframes, it is doing something that is still more a claim than a reality.

It is apparent from the Lafayette announcement that the company can speak the data base language. To quote: "MDBS provides a full network capability and even generalises some features of the Codasyl approach. For example, instead of restricting a set relationship to be "one of many", MDBS permits "many to many" set relationships. A record type can be both the owner and member of a set relationship. Full database security is maintained by providing read and write access levels for all record types, items, and set relationships".

Well, I've recorded the appearance of the Software, and that's all that anyone can do until some enterprising dealer gets onto PO Box 248, Lafayette, Indiana 47902 and arranges a month's hard use trial.

16-bit Monnex

Not the cheapest 16-bit micro on the market at £1,250, is the Monnex system developed by Systems Reliability for its commercially successful TEL-TAG telephone management and



After amusing ourselves at the Atari's expense last month when the distributor dressed two models in sports clothes to play video games, we relent here to show the Atari 800 (expected to cost under £750). There is still no need to get worked up about it, nice though it may look: demand in the US will exceed supply this year, say the importers. Don't expect to see any in the shops until June at the earliest. Details from 0628 32839.

information system.

That price buys a Texas Instruments 9900 micro, 8K bytes of read-and-write memory, 22 programmable lines for data input and output plus two serial communications ports; and a real time clock with two subsidiary timers. Details from Luton 38581.

Sinclair surprise cheapie

Clive Sinclair, the inventor of the pocket television ("for deep pockets", as Electronics Weekly once commented) has done it at last.

Exactly what he has done is to produce a personal micro with keyboard and TV interface and BASIC for under £80 in kit form, and I for one don't know how. Its only apparent drawback is the fact that it uses a touch sensitive keyboard. This is great for preventing spilled coffee or beer from getting into the switches and no doubt it keeps costs down

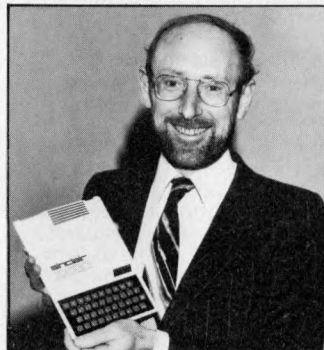

that little bit extra, but it does make touch typing impossible; that requires the operator to keep the fingertips on eight of the keys all the time.

Apart from that quibble, it's obviously non-standard in terms of getting programs off other people's cassettes. Sinclair has hinted that his BASIC is greatly compressed and uses a quarter of the memory that a competing BASIC would use — both for itself and for programs that run under it. This saves money, but since nobody else has done it, their programs will need to be rekeyed and

slightly modified to run on the Sinclair machine.

I am assured by Sinclair himself that I must have got this information from one of the advertising departments of the eight magazines in which he is advertising the launch of this machine. This is a tremendous relief. It means that, having assured my readers that all the people whose opinions I value are agreed that Sinclair has been very clever in the design of the machine, and that it looks like a bargain, I can almost certainly direct you all to the advertising pages of this journal for details. I know it's there, because Uncle Clive told me so, in a very suspicious tone of voice. . .

Apple slices prices

With a sense of triumph that can be felt through the small print, Apple distributor Microsense has cut prices on the Apple II. New prices for the machines start at £695 for a black-and-white display version with 16K bytes of memory or £744 for a colour display model. The full glory of a 64K byte Apple II with Pascal, Integer BASIC Applesoft (all software) two disc drives and controller, is now yours for £1780 plus tax.

According to Andre Souzan, president of Eurapple, these price cuts, far from being in response to competition from ITT (or critical comment in PCW) are due to "the level of cost effectiveness that our sales volume in the UK has allowed us to reach".

At Microsense, Mike Brewer, chairman, stated: "The Apple II European version now retails in the UK after allowing for necessary



Not just a pretty picture, the music shown here. It plays, through an Apple II synthesizer card now announced in the UK by Microsense at £180 — a much lower price than I was expecting. You can attach up to three of these synthesizer cards, and each will play three notes simultaneously. Unlike the HP-85 programmable BEEP, this will emulate the sound of any instrument you care to copy; I've heard it does a very good harpsicord.

Your Commodore PET System

The Commodore PET is Britain's best selling microcomputer and the most popular choice in every field:-

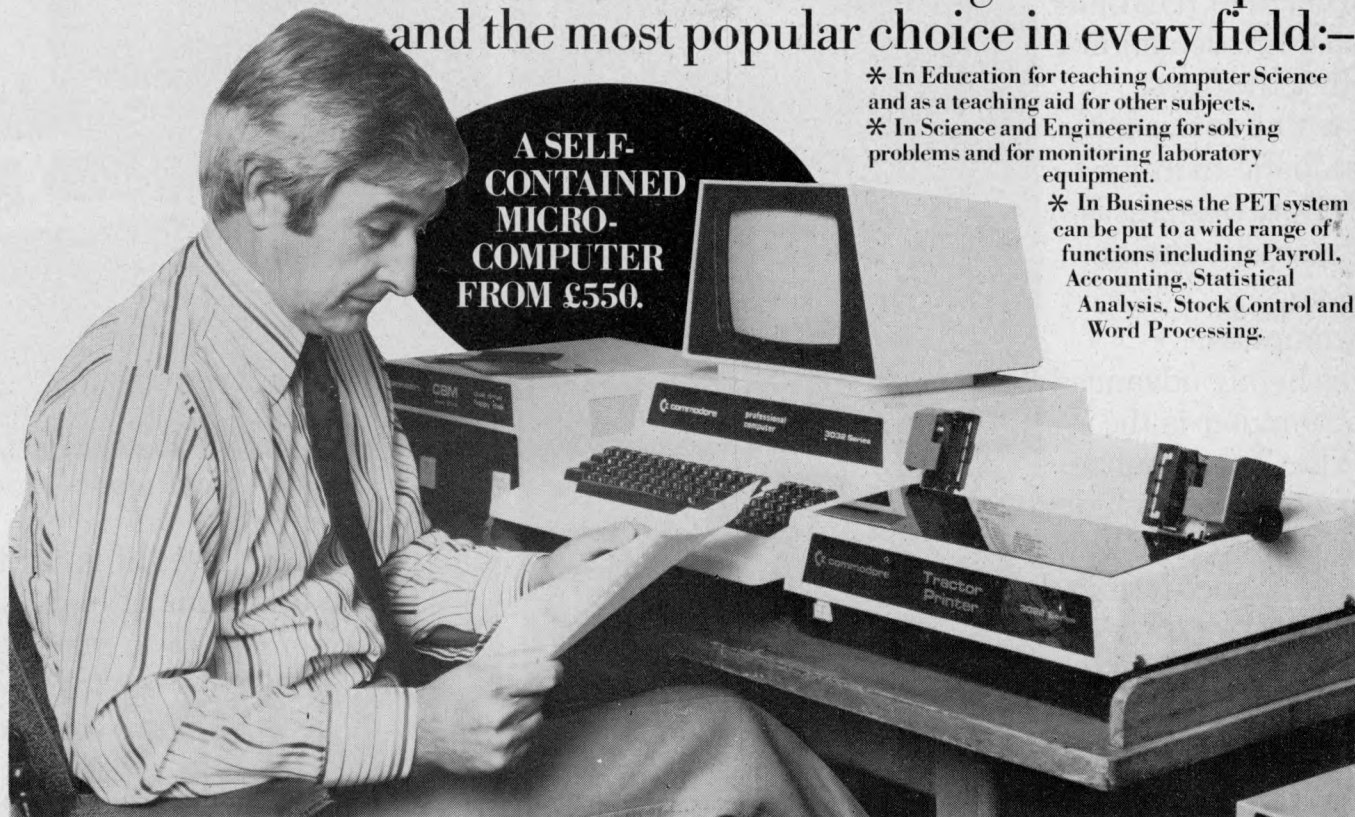

* In Education for teaching Computer Science and as a teaching aid for other subjects.
* In Science and Engineering for solving problems and for monitoring laboratory equipment.

* In Business the PET system can be put to a wide range of functions including Payroll, Accounting, Statistical Analysis, Stock Control and Word Processing.

Not least of its attractions is the price of a PET - from £550 for a self contained unit, to under £2,500 for the complete system including Floppy Disk Unit and high-speed Printer. Ask your nearest Commodore dealer below for details about Commodore hardware, software and training courses.

Our Dealer* Network

LONDON

Capital Computer Systems, W1. 637 5551
ACE (by Top TV Ltd), SW1. 730 1795
Micro Computer Centre, SW14. 876 6609
Logic Box Ltd, SW1. 222 1122
Sumlock Bondain Ltd, EC1. 250 0505
Da Vinci Computers Ltd, NW4. 202 9630
L & J Computers, NW9. 204 7525
Adda Computers, W1 408 1611
CSS Business Equipment Ltd, E8. 254 9293
Advanced Management, EC2. 638 9319
Metyclean Ltd, SW1. 828 2511
Microcomputation, Southgate. 882 5104
T.L.C. World Trading Ltd, WC2. 839 3894

HOME COUNTIES

Orchard Electronics Ltd, OXON. 0491 35529
D.L. Chittenden Ltd, CHESHAM, 4441
J. R. Ward Computers Ltd, MILTON KEYNES, 562850
Dataview Ltd, COLCHESTER, 78811
South East Computers Ltd, HASTINGS, 426844
Symtec Systems Ltd, SOUTHAMPTON, 38868
Alphascan Ltd, BANBURY, 75606
Super-vision, SOUTHAMPTON, 774023
Millhouse Designs Ltd, ALTON, (042) 050374
Micro Facilities Ltd, MIDDX, 979 4546
DDM, BRENTWOOD, 230480
Stuart R. Dean Ltd, SOUTHEND, 62707
Alpha Business Systems, HERTFORD, 57423
HSV Microcomputers, BASINGSTOKE, 62444
HSV Microcomputers, SOUTHAMPTON, 22131
RUF Computers (UK), BURGESS HILL, 45211
Wego Computers Ltd, CATERHAM, 49235

T. & V. Johnson, CAMBERLEY, 62506
T. & V. Johnson, OXFORD, 721461
Petalect Electronic Services Ltd, WOKING, 23637/21776
Business Electronics, SOUTHAMPTON, 738248
Amplicon Micro Systems Ltd, BRIGHTON, 562163
Bromwall Data Services Ltd, HATFIELD, 60980/64840
MMS Computer Systems, BEDFORD, 40601
Isher-Woods, LUTON, 416202
Sumlock Bondain, NORWICH, 26259
CSE (Computers), READING, 61492
Oxford Computer Systems, WOODSTOCK, 811976

MIDLANDS & STH. HUMBERSIDE

Taylor Wilson Systems Ltd, KNOWLE, 6192
Betos (Systems) Ltd, NOTTINGHAM, 48106
Holbrook Business Systems, DERBY, 368088
Lowe Electronics Limited, MATLOCK, 2817
Davidson-Richards Ltd, DERBY, 366803/4
Arden Data Processing, LEICESTER, 22255
Tekdata Ltd, STOKE-ON-TRENT, 813631
C.S.M. Computer Systems, BIRMINGHAM, 360 6264

Business & Leisure Microcomputers, KENILWORTH, 512127
Caddis Computer Systems Ltd, HINCKLEY, 613544
Allen Computers, GRIMSBY, 40568
CPS (Data Systems) Ltd, BIRMINGHAM, 707 3866
Camden Electronics, BIRMINGHAM, 773 8240
Cliffstock (Computer Systems) Ltd, WOLVERHAMPTON, 24221

YORKSHIRE & NTH. HUMBERSIDE

Microprocessor Services, HULL, 0482 23146
Microware Computers, HULL, 562107
Computer Workshop, LEEDS, 788466
Hallam Computer Systems Ltd, SHEFFIELD, 663125
Ackroyd Typewriters Ltd, BRADFORD, 31835
Datron Micro Centre, SHEFFIELD, 585490
Yorkshire Electronics Service Ltd, MORLEY, 522181
Sheffield Computer Centre, SHEFFIELD, 53519

NORTH EAST

Dyson Instruments, DURHAM, 66937
Currie & Maughan, GATESHEAD, 774540
Wards Office Supplies, GATESHEAD, 605915

Tripont Associated Systems, SUNDERLAND, 73310
Newcastle Computer Services, NEWCASTLE UPON TYNE, (0632) 615325

SOUTH WALES & WEST COUNTRY

Computer and Design, BROADSTONE, 0202 697341
A. C. Systems, EXETER, 71718
Computer Supplies (Swansea), SWANSEA, 290047
Sigma Systems Ltd, CARDIFF, 21515
Devon Computers, PAIGNTON, 526303
Bristol Computer Centre, BRISTOL, 23430
J. A. D. Integrated Services, PLYMOUTH, 62616
Sumlock Tabdown Ltd, BRISTOL, 26685
Radan Computational Ltd, BATH, 318483
T. & V. Johnson Ltd, BRISTOL, 422061

NORTH WEST & NORTH WALES

B. & B. Computers Ltd, BOLTON, 26644
Megapalm Ltd, CARNFORTH, 3801
Tharstern Ltd, BURNLEY, 38481
Fylde Business Machines Ltd, PRESTON, 731901
Preston Computer Centre, PRESTON, 57684
RPL Microsystems, DOUGLAS, 4247/8

LIVERPOOL

Microdigital, LIVERPOOL, 227 2535
Rockliff Brothers Ltd, LIVERPOOL, 521 5830

MANCHESTER

Cytek (UK) Ltd, MANCHESTER, 832 7604
Executive Reprographic Ltd, MANCHESTER, 228 1637
Sumlock Manchester Ltd, DEANSGATE, (0618) 834 4233
Computer Workshop, MANCHESTER, 832 2269
Professional Computer Services Ltd, OLDHAM 061-624 4065
D. Kipping Ltd, SALFORD, 834 6367
Catlands Computers Ltd, 0625 527166

SCOTLAND

Microcentre, EDINBURGH, 225 2022
Thistle Computers, KIRKWALL, 3140
McAllister Business Equipment, EDINBURGH, 336 2402

IRELAND

Softech Ltd, DUBLIN, 784739
Medical and Scientific, LISBURN, 77533

*This is a list of dealers participating in associated advertising and not a full list.

commodore

We made small computers big business.

Commodore Information Centre, 360 Euston Road, NW1 3BL. 01-388 5702

Whether you're a software engineer looking for the best hardware — in educationalist equiring versatility and the ultimate in reliability — or an OEM demanding flexibility, the finest documentation available, and 'realistic' margins — Zenith Data Systems is your automatic choice.

Z89 Series Microcomputer.

This highly advanced Microcomputer is the star of the Zenith range.

Specification includes: Floppy disc storage. 48K RAM. 'Intelligent' video terminal.

Two Z80 Microprocessors. Choice of operating systems including CPM.

Standardised communication, RS 232. Prices from £1570

Z11A Series 16-bit computer.

Based on the powerful new 8011-HA CPU (LSI — 11/2) it offers you the speed and versatility of a minicomputer at



Z89

Z19

The Professionals

a microcomputer price. With memory* to 32K words (64K Bytes). Seven additional I/O positions. PDP 11/03 compatible.

Systems from £4335.

*Memory boards available from £562 per 16K.

WH14 Serial Printer.

Microprocessor based electronics makes it capable of a wide variety of uses in most computing applications.

It features 5 x 7 dot matrix. Impact print. Operator/software selectable line width — 132, 96 and 80 characters per line. And sprocket paper feed with adjustable spacing. Price. £510

Z19 'Intelligent' Video Terminal.

Z80 based, it is capable of a multitude of high-speed functions. It has an easy-to-read, high resolution CRT. Heavy duty keyboard. 128 characters. Addressable cursor, relative and direct. Versatile edit functions. And E.I.A. RS 232/c at 110 to 9600 baud. Price. £735



Z11A

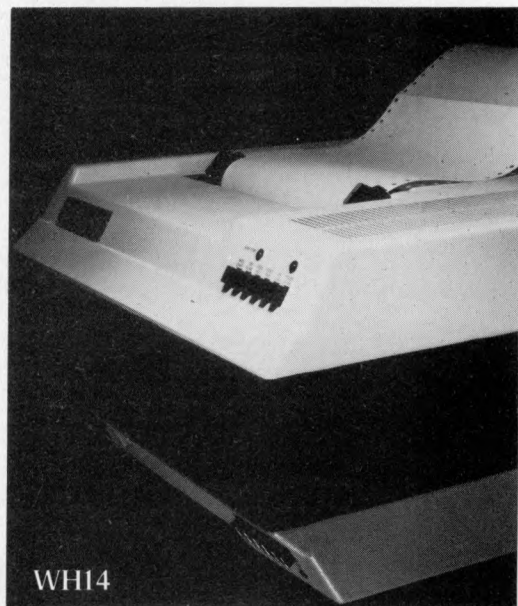

WH14

Zenith data systems
 THE ULTIMATE IN MICROCOMPUTERS



If you'd like more information about any, or all of the Zenith Data Systems range, just contact us at Zenith Data Systems Division, Heath Electronics (U.K.) Limited, Dept (PCW 3), Bristol Road, Gloucester GL2 6EE. Telephone (0452) 29451. All prices are exclusive of VAT and delivery charges. Generous OEM discounts available.

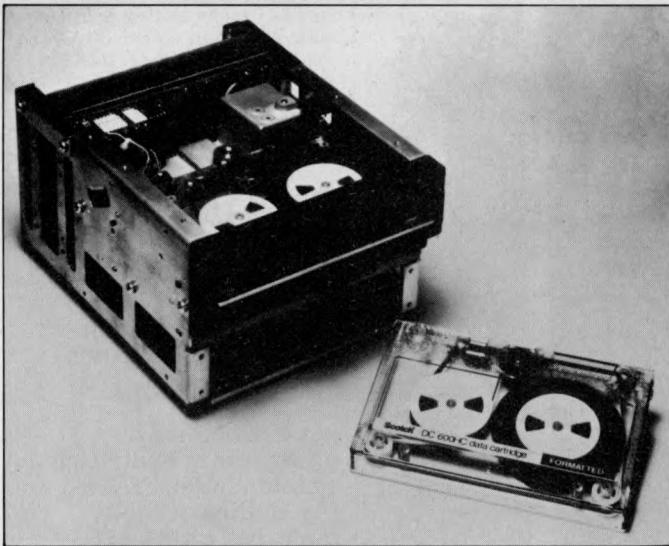

Attempting to catch up with the outside innovators at Courtest, the 3M Company has announced a disc-like tape cartridge as "the first truly intelligent data cartridge drive system". It differs from Courtest's in offering 16 track recording, and in being rather slower; also in being offered purely as a back-up system for the new mini hard discs, rather than as a systems component functioning in real time. There are other differences too. Details on 0344 58550.

modifications and for freight and duty, at very similar prices to those in the United States". Details on Hemel Hempstead (0442) 41191.

Intel chooses cartridges

Micro maker Intel has upgraded its supersystem, the Intellec development computer, to include a large, 7.3 million character, storage disc.

As would be expected of the market leader, it has adopted a conservative approach, using older, established cartridge discs, rather than the new fangled mini Winchester. The thinking is unshakeable; people who are developing new systems do not want to cope with too much innovation all at once. Also, new products aren't always readily available. Intel aims the new system at users of its big 16-bit 8086 and of the 8085, who have a large number of programs available to compile, assemble, link and load.

Keen to sell PETS

One of two distributors of the Apple II up to the middle of last year was Keen Computers of Nottingham. The appointment of Microsense as master distributor was a warning to Keen that it could no longer delegate the bulk sales to sub dealers and collect a small percentage, and that it would have to change its ways in the market. As a result, Dr Tim Keen's company has been the subject of considerable anxiety ever since, culminating in unfounded rumours that it

was going bust.

More important, Keen was forced to look to expand its market. It has now done so on two fronts. First, it sells the Corvus Winchester mini-disc, and second, it sells the PET.

Keen's announcement observed that to date, the company has marketed the Apple II to education and big business markets. Keen's approach to the Apple has always been a bit up-market — for example, where others tend to supply the computer with a card that broadcasts the display (down a wire) into the aerial socket of a colour television, Keen has preferred to sell it together with a colour monitor, taking the output of the computer direct to the red/green/blue controls of the colour tube.

So when Keen refers to the PET as "the best selling machine in the small business market," it's obvious that he sees it as a useful source of volume sales, as opposed to the more specialised deals done with Apple.

The move should convince people that he has found a replacement for any business lost with the Apple distributorship.

Byte shop sold to Comart

Computer enthusiasts were doubtless relieved to hear that the Byte Shop had been sold to somebody who knew the business, rather than to someone who planned to run it like a soap and soup supermarket. It was bought for over £300,000 by Comart's David Broad — one of the first people to sell American microcomputers in this country. Broad's main

anxiety on taking over Byte Shop (1980) was to reassure everybody except South West Technical Products and Ohio Scientific that business would continue as usual.

His own chain of retail outlets — the Comart franchises — are assured that this side of the business will continue to be controlled by John Lamb, "who will have nothing to do with Byte Shop". All former personnel are to be retained, and so are all the shops. The changes are not definite yet, but the fact that the product range would be rationalised was known before Comart took over.

In charge of the rationalisation will be Nottingham Byte Shop manager, John Braga. It is he who will have to decide which machines are to be sold, and which will be dropped. Since Comart handles Cromemco and North Star, it's a safe bet they won't go; and if Nascom keeps delivering up to scratch, with such a good seller, they should be in there too.

South West Tech Products, however, has moved its market position significantly towards selling minicomputers, rather than mail order or retail micros; Braga is known to be looking carefully at that line.

And problems already experienced by Byte Shop in handling Ohio Scientific machines, whether or not they were problems of Byte Shop's own making, have seen the entire stock of machines and parts sold off by the receiver. Contrary to rumour, the PET will defini-

tely not be dropped. "Apart from the money PET makes, we sell so much PET software that we wouldn't like to consider dropping it, even if it caused much more difficulty than it does," said Braga.

The question of what will happen to unsecured creditors of the old Byte Shop is no further advanced than it was when our long analysis appeared last month. The only news is, that, having made "a good sale" of the group, the receiver is now hopeful that they will get 50 pence in the £ — or possibly more.

Hop on the TRS80 bus

When Tandy launched its packaged microsystem, everybody pointed out that it would never have the benefit of being a standard add-on bus machine, like Altair, and that the job of expanding it would, therefore, be costly. Ingenuity will always find a way to prove these predictions wrong. In New Jersey, a company called Hartmann Lang is releasing add-on hardware for the TRS 80, by the devious method of using the official connector socket at the back of the computer, and expanding it to what Hartman calls the STD bus — a 56 pin 8-bit bus supported by "products from numerous manufacturers".

Hartmann-Lang now has available the following products for the TRS 80/STD bus: the bus interface, a 6 slot STD bus mother board,

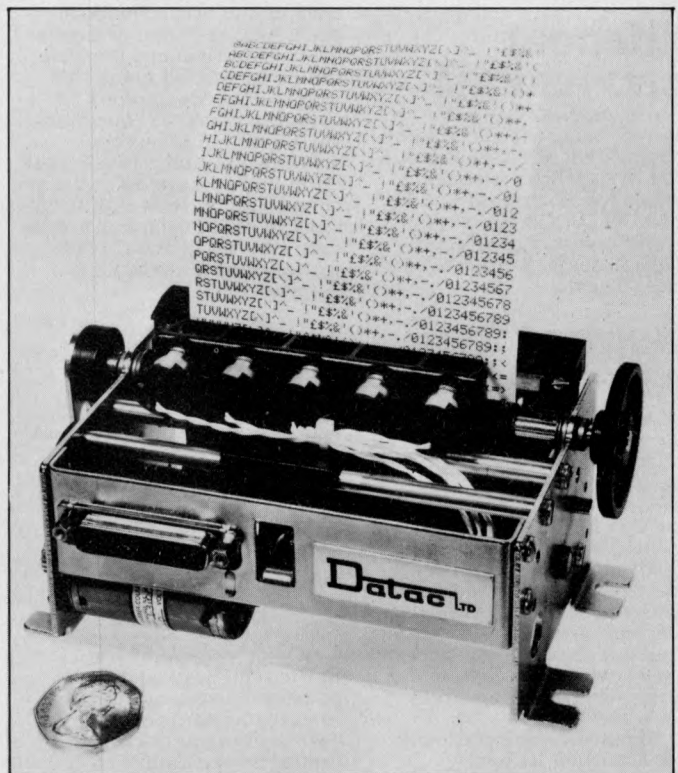

This little print unit costs £139, and will produce 120 lines of output a minute with its five print heads. It needs drive circuitry, and it is available without this from Datac on 061 941 2361.

a 16 channel ten and twelve bit analogue to digital converter board, a four channel 12-bit digital to analogue board, an eight channel reed relay output board, an eight channel triac board — useful for varying the speed of electric motors or the intensity of lights — plus a range of memory boards, input output ports, and printer interfaces.

Software available includes an intriguing emulator of the 6502 which, if it works, will allow the TRS-80 to run any program written for the Kim or PET family in machine code. There is also a collection of operating utilities, to make loading information from cassette easier, and to help with machine code programming.

For the freaky, there is a monitor program — written in BASIC — which “makes an interesting case study in interaction between machine code and BASIC”, comments the company. At least it isn't claimed to be any kind of useful breakthrough.

PET EPROM burner

A hardware and software package which allows PET users to “blow” erasable read only memory chips has been launched by GR Electronics. This allows the user to load permanent programs into silicon, for insertion into the PET itself, or into other micro based systems that will take the right chip. The chip is the single voltage 2716 EPROM. Details from 0633 67426.

Lifeboat carries mail

A mailing list system for any system using the CP/M operating system has been announced by Lifeboat Associates. It's called Postmaster, and it costs \$150. Details of your systems would be needed, since it comes in over 20 diskette formats.

Commodore goes soft

Commodore has given a big boost to writers of PET software by getting them all together in one place, to swap good ideas. It held a meeting early in February, to show its dealers what software had been sent in and approved, and no doubt the result will be that a great many more software products that were available from one or two outlets will suddenly appear from new dealers around Europe.

Meanwhile the company has launched its own Wordpro II word processing software at £75, for the big keyboard PET. With diskettes



Prices start at £218 for a new pair of printer ranges from Digitec, through dealer Aviquipo in Maidenhead. Details on 9628 34555.

and printer, Commodore estimates that a working word processing system would cost £2600; one with a daisy wheel printer, giving typewriter quality printout, would cost more, “but would still cost less than £4000”.

A model system

Financial modelling facilities for an Apple II now cost £95. That is the retail price of software, called Visicalc, which Personal Computers is selling as “a large financial notesheet that can be moved in any direction, to highlight specific problems”. The notesheet accepts the user's financial problems, and then illustrates the overall financial position on the screen, allowing the user to find the answers to complex “what if” questions. Mike Sterland offers the information that Visicalc cost £200,000 to develop — the need to sell at least 2,000 systems to break even must indicate something about what sort of people are buying Apples.

Newbear expands

Newbear Books, a division of the Newbear Computing Store, has opened another branch in Birmingham. It is at the Tivoli Centre, Yardley, next to the Swan landmark. Details from Dave Sperry or Sue Dunn on 021 707 7170.

Make a date

In the same way that a marriage bureau allows you to date one of its clients before filling in the licence, Productivity Unlimited management consultants has set up a room where prospective micro users can have an

intimate session with their hands on the micro — in a new centre in Gerrard's Cross. Andrew Jackson on 02813 89248 will give details of software available for test on Apple and Microstar computers.

Stop Press

The Third Personal Computer World Show will be held at the Cunard International Hotel in Hammersmith, London on Sept 4, 5 and 6th 1980.

Organizations interested in exhibiting should contact Timothy Collins of Mont-build Ltd on 01-486 1951. Further details will appear in next months P.C.W.

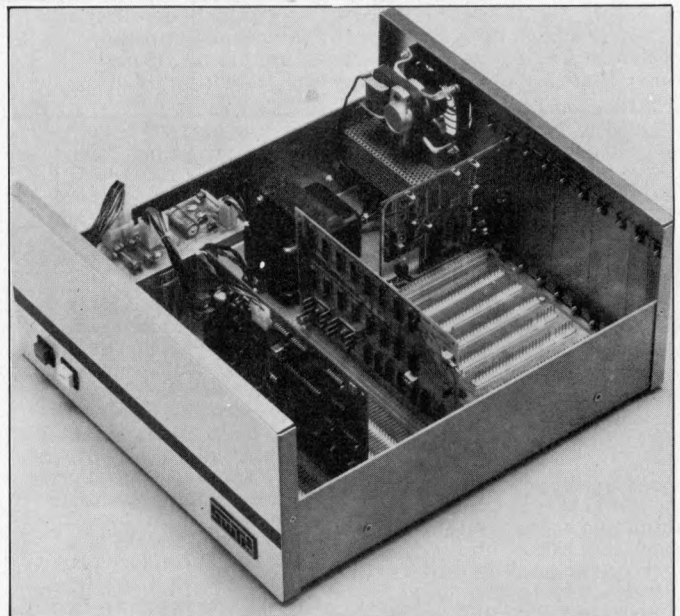

This is the box in which SWTPC sells its 6809 computer. Prices start at \$595 in the US. Details there on 512 344 0241.



To prove how clever they are, the guys at Logic Box in London have dreamed up the idea of putting a rev counter on the tape cassette of a PET. And to show how clever they really are, they are not going to sell it, or help you design it; you can have the idea of fitting it via a slotted spindle onto one of the tape drive wheels, drilling through the plastic cover — FOR FREE. Logic Box does sell an add-on cassette deck, with tape counter and loudspeaker, for the PET, at the PET price — when you get frustrated trying to build your own, you can buy theirs. On 01-222 1122.

Guy Kewney is technology editor of Computing.

The Panasonic

*Now you have decided why to get it,
a little reflection will tell you where.*

To the Customer

By now, all the advantages of buying Panasonic will be clear to you. As a spectacularly powerful, flexible and self-contained machine, the Panasonic's claim to supremacy amongst computers almost goes without saying. But if you knew nothing of DDP Five Star Computing or the range of CAP programs with which DDP support the Panasonic, you could be excused for thinking that where to buy might present a problem.

On the one hand, Five Star Computing is our literal Commitment to Excellence across the whole spectrum of DDP products, services and expertise. To uphold that commitment in the case of the Panasonic we rely, in part, on our wide experience at both ends of the computing scale. In particular, as the largest and longest serving UK distributor of the smaller ITT 2020 and as a 'System Builder' for the big Honeywell Level 6, we believe that we are uniquely suited to solving the problems of the Panasonic operator in the middle of our 'turnkey' computer range. Our confidence is also due, on the other hand, to our Five Star endorsement of the CAP programs for the Panasonic. One of the World's largest software houses, CAP have written such programs specifically for microcomputers like the Panasonic, but in such a way as to give enhanced performance comparable to that achieved on the very largest computers.

For both these reasons, your logical choice is to buy a DDP Panasonic. But if you are still unsure, please contact us and we'll go into the whys and wherefores together.

To the Dealer

To help support the growth of Five Star Computing, we are currently interested in extending our dealer network in the South-East to include more Panasonic outlets. Therefore if you are interested in becoming a DDP Five Star Panasonic Dealer, please contact Nick Yates at DDP now.



 **Five Star Computing**

A Commitment to Excellence from Distributed Data Processing
DDP Ltd, Essex House, Cherrydown, Basildon, Essex
Tel: Basildon (0268) 282155

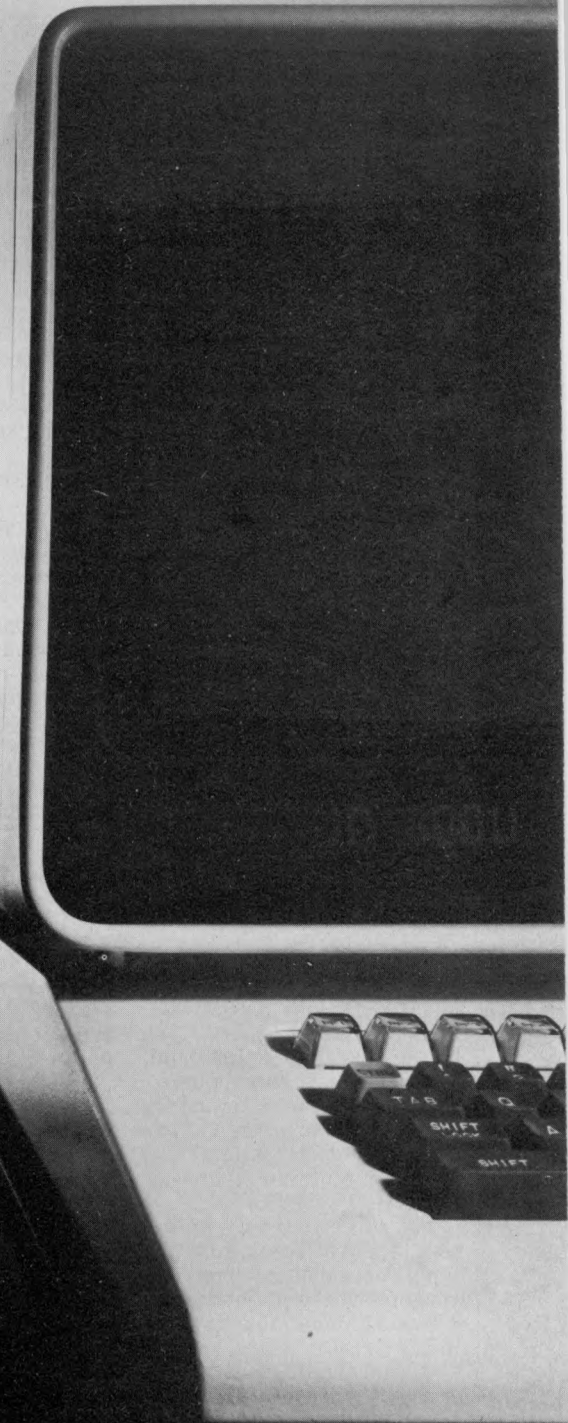

COMMUNICATION

PCW welcomes correspondence from its readers. Be as brief and concise as possible and please add "not for publication" if your comments/questions are to be kept private.

Address letters to: "Communications", Personal Computer World, 14 Rathbone Place, London W1P 1DE.

Cryptic comments

Excellent magazine. Like new format. Superlative show, superlative staff. Catering (restaurant) worse than lousy. Why don't you choose another venue if you must have it in London? Come to that why not move the show around the country? You'll eat better with our Northern hospitality and pay less, and we know better than the rudiments of service (which is more than can be said for a certain West London Hotel). Would you care to review the Superbrain? I'm sending a letter about the TI 59 review — watch out. Pascal series excellent. Why the hell can't you finish a **** article on the next page instead of completing it on some spare corner of some column twenty pages away. Use a word processor and edit out surplus text. Particularly on serious articles which your readers will wish to photocopy. Get the spelling right, and/or employ a proof reader. Happy new year. J. D. Briggs, Scawthorpe, Doncaster

Comments noted. What surplus text? Noticed the spelling improvement since November? — Ed.

Prizepraise

I thought it would come as a pleasant surprise to receive a letter glowing with admiration and praise, but as you didn't send me one, I'll send you one instead.

Needless to say I enjoyed my Christmas and New Year very much, thanks to the generosity of PCW. The Sharp MZ-80K will give me years of fun and interest and the opportunity to experience divorce first hand. I am currently working on a short transparent program for Sharp, PET etc. using TI\$ to prompt the programmer every 5 minutes or so to "SPEAK TO SPOUSE".

On a more personal note, I should like to thank everybody for making me feel so welcome at the presentation — a most memorable day for me.

If you should want a "users" appraisal of the machine sometime in the future, I should be happy to

supply one.

Once again thanks for everything. Terry Rigby, East Sheen

For those who don't know, Terry won the Sharp MZ-80K as a result of being first out of the hat in our recent readers survey. The machine was donated by Sharp and upgraded and guaranteed by Personal Computers Ltd. — Ed.

Prestel postbox

In December's Newsprint column you expressed surprise that ITT have announced a message keypad for Prestel. In fact the Post Office's prototype Prestel has got a mail box facility to allow users to swap messages. For some reason this has not been implemented in the commercial version for public use. I doubt that this is a Post Office secret since both versions were demonstrated at a local branch meeting of the BCS last year. Why not ask Prestel?

J McIntosh, Liverpool, Lancs

We asked Prestel and they tell us that there are no firm plans to make this facility available. Perhaps it poses too much of a threat to conventional mail. However, there is a form of message swapping service available now, in which details of an order for goods or services may be left for subsequent processing by the supplier — Ed.

Ghanaian gripe

I like the 'new look' PCW, because it gives more facts and information.

The new 'Bench Tests' are far better than what you were doing before. I hope you will do one on the Apple.

The new series 'Computer Answers' and 'The Complete Pascal' are very welcome.

'Bookfare' (Sept & Oct) is a disaster. Please change it quickly. The type of book review that I appreciate is the sort of thing we had in April or February of this year.

And now I am going to request one thing. In fact I will go further and beg you, on bended knees if necessary! Please do not print different articles back to back on consecutive pages. It only annoys

and frustrates those of us who cut up PCW and file it for future use. For example, in the October edition the 'Mini-Bench Test on the Sharp MZ-80K' was back to back with 'The Complete Pascal'; I wanted to file both articles, but couldn't. Please space such articles with adverts if necessary.

Now let me underline this last request once more!

By the way, I preferred the type you used on the original PCW.

Thanks for a good magazine.

G.R.Hunt, Tamale, Ghana

Thanks very much for your comments — we welcome both good and bad, as long as they're constructive. As far as your request about articles backing each other is concerned, this would involve putting far more advertisements into the body of the magazine. We feel that this would then make the interesting bits harder to find. I suppose you wouldn't consider buying two copies each month? . . .

All go algol

Pascal is being pushed by many people, as they think it should be the new language for the eighties. Unfortunately, a Pascal system is a very tight squeeze, even on big micros and yet on larger machines it has drawbacks when compared with a language such as Algol 68. I would suggest that Algol 68S, a strict sublanguage of Algol 68, would be a much better choice for micros such as the Z80 or 6809. This would allow users to "upgrade" to full Algol 68 when available with little trouble. Algol 68S is very clear and produces good code without complex optimisation. It has many features not found in Pascal, and is easy to learn.

An example of the language in use would be a solution to the "Pascal Question Mark" in the January 1980 issue:

```
FOR L From a BY 2 TO 19
DO IF L =x
```

```
THEN first thing
ELSE second thing
FI
```

OD

This shows clearly what is going on, and should produce efficient code.

The program body of the Sales Ledger in the same

issue would be easy to write in Algol 68S. The Algol 68 CASE has an OUT clause to take care of the selections which are not found. Notice also that the INTEGER value "selection" is only declared where it is needed:

```
DO menu;
  print ("please type in your selection");
  CASE INT selection:read (selection);
  selection
  IN
  list,
  stock code,
  invoice,
  amend,
  total
  OUT
  ESAC
  print("goodbye");stop
OD
```

Note that DO. . . .OD is equivalent to WHILE TRUE DO. . . .OD. Now an exercise for Pascal users: Write the equivalent of the BASIC code:

```
100 FOR J=A TO B STEP C
110 . . .a. . .
200 IF M=N THEN GOTO 400
210 . . .b. . .
300 NEXT J
400
```

The Algol 68 version would be:
FOR j FROM a BY c TO b
WHILE . . .a. . . ;n>=m
DO . . .b. . . OD

P.S. I enclose some ideologically sound stickers to stick round your office!

Raymond Anderson, Nottingham

Thanks for the Algol fan club stickers. The ones that haven't been nicked are now stuck round our ideologically sound office — Ed.

Home help

I should like to commend to your readers Compshop Ltd. Recently I visited their premises at 14 Station Road, New Barnet to see the Compukit UK 101. The staff were very helpful and enthusiastic, answering all my questions and spending as much time with me as I could wish.

Eventually I purchased the Compukit and during assembly telephoned the Compshop several times to ask advice of one sort or another. Always they were very pleasant and helpful. A few small components were found to be missing from the kit; these arrived within about four days of my telephoning the shop!

I believe that a firm who are willing to take trouble over a small customer such as myself, will be equally efficient over a customer spending much larger sums of money.

J.M.H. Taylor, Harrow, Middx.

Apple tip

Although the documentation on the use of the DOS for the APPLE is extremely well presented, well written and lists the various PEEKS and POKES and CALLS relevant to disc use, one point which perhaps is not brought out as clearly as it might have been is how to get from APPLE-SOFT or PALSOF into the monitor without the facility of being able to return via the recommended 3D0G, because, for instance, that area is being used for some other machine code programs.

In order to get round this, if, instead of getting into the monitor by pressing RESET, instead you do it by a CALL — 155 from the relevant BASIC you'll find that you can return from monitor by just typing FP and hitting the return, DOS intact.

The same process is the one used when controlling the Apple from an EXEC text file. This is where the machine is controlled by a sequence of instructions previously stored in a text file — the APPLE reacts to the instructions read from the text file just as if it had received them from the keyboard.

Richard Lawrence, Harlow, Essex

Frequency fudge

While at the Personal Computer World Show in London, several people asked me if I could let them know how to convert a VDM-1 (S-100 alphanumeric/graphic board from the late lamented Processor Technology) to operate on 50 Hz. These particular people have been notified, but in case there are any PTC "orphans" around, here is what to do.

On the VDM-1, disconnect pin-5 of IC8 from pin 6, and connect it to ground (pin 4). This increases the modulus of the counter to 8 in the VDISP element. This results in four extra character lines on the display. The total is now 312 lines per field, the equivalent of 624 lines per frame (sound familiar?). The field rate is now close enough to 50Hz to reduce the "swimming" effect to less than 0.1 Hz.

If you have trouble centering the display on screen — probably due to standoff time

to VSYNC from the bottom (which is still on the 60 Hz standard), increase the value of R34 (located in series with the VPOS control).

Les Solomon, New York

Tandy tunes

I am a young reader of your magazine (11) and I share a TRS-80 with my brother. My other interest apart from programming is music and I would like to add a music function to it. I would like the function to provide three octaves and various types of sound (clarinet and recorder). I would also like to see more TRS-80 level 1 programs in your magazine.

J. P. Chessell, Worthing, Sussex.

The word from Tandy is that they sell a music program called Micromusic. It has a five octave range and can play sharps, flats, whole notes, half notes, quarter notes and eighth notes. You can play the music by either recording it and then playing it back, or by attaching the grey cassette lead to an amplifier. As far as TRS-80 level 1 programs

are concerned, well we'd be happy to publish them if readers would care to submit them — Ed.

Nascom notes

I bought your magazine for the first time at the 'Breadboard' exhibition in London, after meeting Don Finlay and seeing his article on Nascom words and music. Unfortunately I cannot find a firm who can supply the DAC 1 and 2 for this circuit. These components are numbered MC1408L8. I would appreciate it if you could let me know where I could buy them and how much they cost. Sorry for the trouble. D Blackburn-Kane, Chard, Somerset.

No trouble at all, we called Don Finlay who very kindly supplied the following list: Crellon Electronics Ltd., Slough, Tel: 06286 4434 Celdis Ltd., Reading, Tel: 0734 585171 ITT Electronic Services, Harlow, Tel: 0279-26777 Jermyn Industries, Sevenoaks, Tel: 732-51174

Macro-Marketing Ltd., Slough, Tel: 06286 63011 He also thinks that some of these firms have a minimum order value, probably around £10. One MC1408L8 should cost £1.88 or thereabouts (last Novembers price) — Ed.

Research request

I am a final year student at Sheffield City Polytechnic, taking a degree course in Computing Science. My final year project is concerned with a study of the use of microcomputers in business applications. If any of your readers in the Sheffield area are using micros in business applications and are willing to help me in my investigations, would they either please write to me or phone Barnsley 45615 to arrange an interview. Any users not in the Sheffield area could help me by sending their address, and I will send them a questionnaire.

Steve Brown, 73 Swanee Road, Kendray, Barnsley, S. Yorks



Feedback

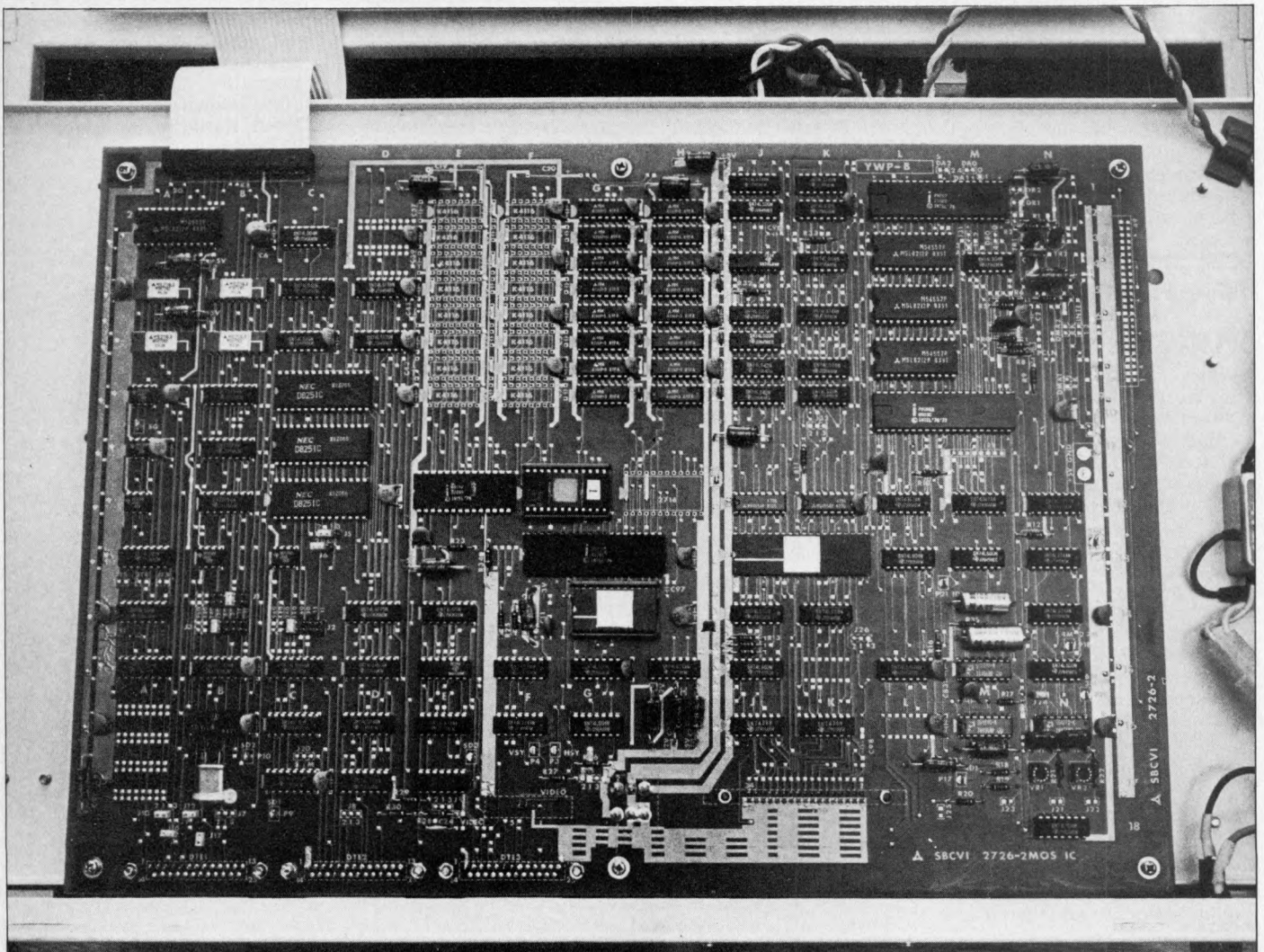
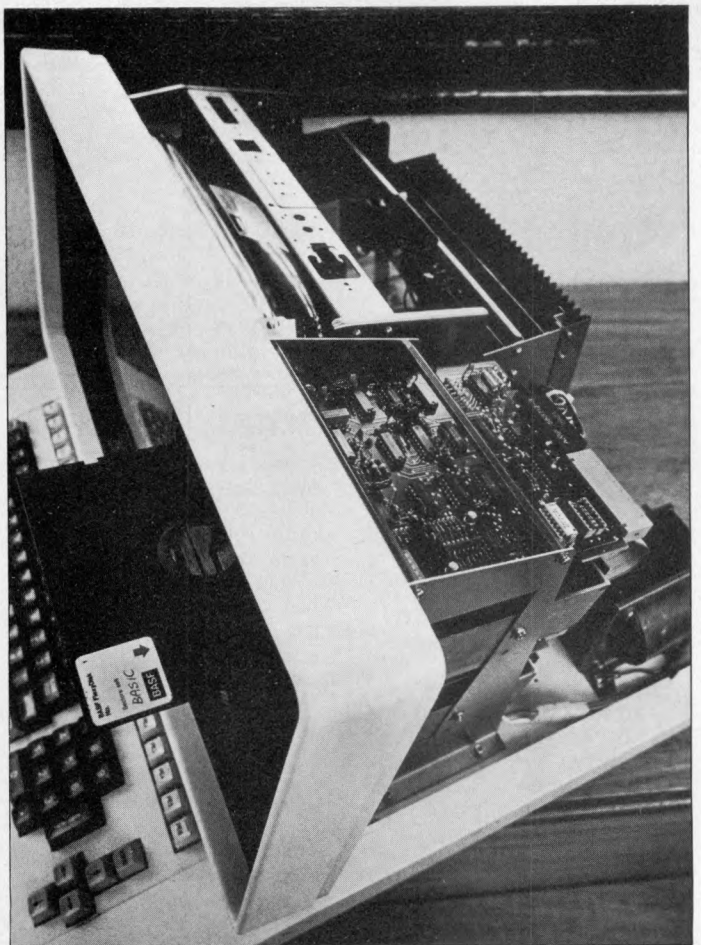

Top left: a general view of the Panasonic JD-700U; note the top row of user-assignable function keys. Top right: a peep inside shows the usual arrangement of disc drive, PSU and CRT. Bottom: revealed, the single board computer, with 8085A, 2MHz CPU, memory and all the circuitry for the disc drives, CRT and three RS232C ports.

BENCH TEST

PANASONIC JD-700U

With its JD series Panasonic has established itself as the first Japanese contender in what looks to be an increasingly competitive market . . . namely small businesses who find the PET and its rivals too limiting yet who aren't ready for the boxes and wires of a bus based machine with separate VDU. As is expected from the Japanese the hardware is well designed and built, although you couldn't say that it actually breaks new ground; neither does the software, which will need considerable development in order to exploit fully the available hardware features. Software enhancements and, of course, pricing are likely to be crucial factors in the battle for this market.

by Sue Eisenbach

Hardware

The Panasonic JD-700U is a single unit personal computer weighing 30kg. Because the peripherals — keyboard, screen and disc drives — are all contained within the cabinet, access is necessary only for maintenance or repair. The white metal case can be removed by unscrewing six retaining screws (the fan also needs to be disconnected). Revealed are the CRT, the disc drives and the power supply. To get to the computer itself, the unit has to be turned over on its side thus allowing access to underneath. Remove the black metal cover plate and the single board computer will be revealed, complete with 8085A, 2MHz CPU, memory and all the circuitry for the disc drives, CRT and 3 RS232C ports.

The review machine came with 32K dynamic RAM (4116s) which can be expanded to 56K. Above this 56K address space is 2K of static RAM for the CRT. The next 2K of address space isn't used, while the top 4K is reserved for PROM. There was a 2K (Intel 2716) PROM containing the bootstrap and a space on the board for an optional 2716 PROM.

The Intel 8257 direct memory access (DMA) controller is used to transfer data between memory and floppies or CRT display; it has the capability of transferring blocks up to 16K bytes between memory and peripheral without CPU intervention. The disc drives are controlled by a FDC 1771 floppy controller and each disc has a formatted capacity of approximately 71.68K bytes held on 32 tracks. Each track is divided into 16 sectors, each of which contains 128 bytes. Data is transferred using DMA in sector units with an average access time of 463ms. Panasonic are proud of the fact that they build the drives themselves.

The screen is 12 inches and provides 24 lines of 80 characters, which can be displayed in normal, highlight, reverse, underline or blink mode. The CRT is controlled by the 8275 programmable CRT controller. The characters are 7 x 12 dot matrices in a 10 x 14 dot matrix field. The screen is p.39 green phosphor and designed to minimise eye strain. Unfortunately, images linger long

enough after a line has scrolled up for it to be a distraction.

The keyboard consists of 95 keys divided into five different sections: standard qwerty, numeric keypad, cursor pad, editing keys and function keys. Each key can send four different 8 bit codes (using SHIFT and CONTROL). None of these codes is for graphics, rather there are several key combinations for every character (including lower case letters). Although the cursor pad provides an easy method for moving the cursor around the screen, none of the software provided acknowledges input from these keys. The six editing keys have no appreciable effect on either the screen image or the text being typed in. The input from both the cursor keys and the editing keys can be accepted through machine or assembly language programs and the fifteen function keys are set up for easy use in the BASIC system. Under CP/M the function keys have no effect, but can also be used through machine/assembly language programs. The labels on the function and editing keys (PF1-PF15, PE1-PE6) can easily be replaced with appropriate titles.

There are three RS232C ports easily accessible at the back of the machine. Ports 1 and 3 are for asynchronous transfers while port 2 can be used for either synchronous or asynchronous transfers. For asynchronous transfers speeds can be set (using a shorting plug inside the machine) between 110 and 9600 baud, whereas synchronous transfers can be set between 1200 and 9600 baud. The ports can be accessed through both CP/M and BASIC.

My overall impression of the hard-

ware is that it is robust and thoughtfully designed. The single board computer is clean and isolated from the heat producing power supply, drives and CRT. A design decision was made to use the CPU only for processing. Control of peripherals and memory transfers is delegated to programmable control devices.

Software

Two discs with the system software were supplied — one labelled BASIC, the other CP/M and to use either system the appropriate disc must be placed in the top drive (called 1 in BASIC and A in CP/M). Upon powering up with the BASIC disc in place, BASIC is automatically loaded into main memory and the following message appears on the screen:

```
BASIC Rev. 5.0
[Matsushita version]
Copyright 1977 (c) by Microsoft
8025 Bytes free
Ok
```

Despite the Rev number this is not Microsoft's new version 5 BASIC 80 but rather their previous Extended BASIC with a few extra features.

Four new BASIC commands associated with the function keys are:

- 1) KEY ASSIGN (string expression) TO PF(n) associates a string with key n.
- 2) KEY LIST prints key definitions on the CRT.
- 3) KEY SAVE (filename) saves all key assignments in the designated file.
- 4) KEY LOAD (filename) fetch all key assignments from the designated file.

The keys have initial assignments that include RUN, EDIT, PRINT etc.

TECHNICAL DATA

CPU	8085A, 2MHz
Memory	32K bytes dynamic, 2K bytes static (CRT), 2K PROM
Keyboard	95 Keys
Screen	12", 24 lines x 80 characters
Cassette	N/A
Disc Drives	Twin 5" discs, single density
Printer	N/A
Bus	N/A
Ports	3 RS-232C serial ports
System Software	CP/M
Language	BASIC, 8080 Assembler

In addition to the CP/M Microsoft BASIC disc accessing commands there are several commands that allow the user to have greater control over disc accesses. DSK1\$ (D,T,S) reads a string from disc D, track T, sector S while DSK0\$ D,T,S(string expression) writes the string expression to the stated sector. For all other accesses the file directory must be in memory. This is achieved by MOUNTING the disc. Before changing discs the first one should be REMOVED in order to update the disc directory. Files and discs can be SET to provide write protection or read after write checks, while the ATTR\$ function returns the current attributes of a file or disc. The DSKF function returns the number of free groups (1 group=8 sectors) on a disc.

The 3 RS232C ports can be accessed directly in BASIC by using PRINT%, PRINT% USING, INPUT%, LINE INPUT%, INIT%, INPUT\$ and PORT with appropriate port number. CSRLIN returns the line number of the cursor while LOCATE positions the cursor. FLP\$ is used to set the display to normal, blink, highlight, reverse or underline. Unfortunately there is nothing in BASIC for setting up or using the keyboard editing keys.

With the CP/M disc loaded in the top drive, CP/M rather than BASIC, comes up. Panasonic CP/M is a fairly standard minimal system. Minor differences include not implementing MOVCPM (The CP/M system can only be moved into memory by using SYSGEN), enhancing the STAT command and adding a command RSMODE. There are three possible logical peripherals (paper tape reader, paper tape punch and printer) that can be assigned to an RS232 port and STAT enables the user to enquire about what device is attached to each port as well as to alter the attachment. RSMODE allows the user to change information such as parity, character length etc of any of the RS232 ports. Although Digital Research expanded CP/M to allow for easy interface with the RS232 ports, no account was taken of any of the special keys on the console keyboard.

Potential

In small business terms the most useful, non-standard hardware features are the cursor control and programmable function and editing keys. Accompanied by suitably configured software, these can provide an ideal turnkey business computer making powerful editing facilities and entire programs available to an unskilled operator at the touch of a single key. Likewise, a development system could be streamlined by associating system commands with individual keys. Perhaps after general release, some software house will undertake the development of a CP/M implementation which is configured to exploit this powerful and convenient option.

The Panasonic BASIC has some unusual features for business software. Both the extra disc handling features and the easy to use function keys should allow for straightforward development of BASIC business systems that are easier to use and more secure



A close look at the Panasonic's comprehensive keyboard. Opposite: when scrolling, the characteristic high screen persistence causes severe "ghosting" of the image.

than systems developed in standard Microsoft BASIC.

Looking at the hardware, I think Panasonic are aiming at the word processing market. The special keys, neat appearance, ease of use and RS232 ports make it a nice word processor of word processing terminal in a network, always provided the software is forthcoming.

As a machine for educational purposes the Panasonic has its advantages. In its favour is its compact form and robust casing. It should survive frequent changes in location and much battering. Also having CP/M as its operating system means that the full range of CP/M system software is available.

Against these advantages should be balanced the price, lack of graphics and slow speed. In these times of educational cutbacks it is unlikely that the desirable features of the Panasonic are worth the money. Graphical techniques are useful in both CAL and the teaching of programming, while the benchmarks show that there are faster BASIC systems for users who want to use a machine for data logging or number crunching.

An expensive machine without graphics capabilities with delayed screen

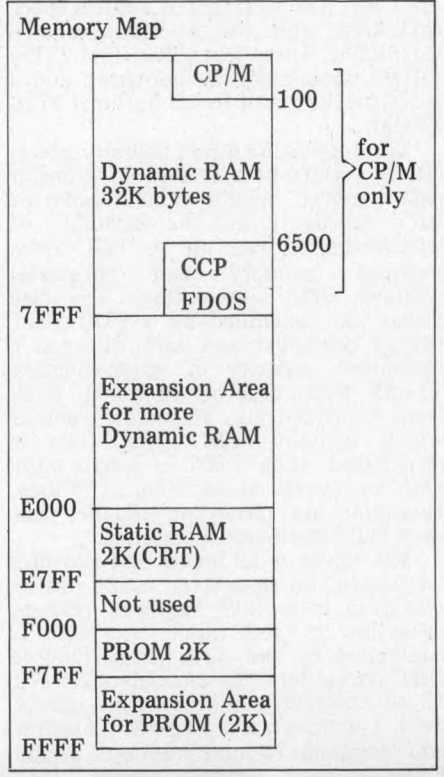

```

540 REMD:CPMTHENS=02L9E100KDB:IFKB5+1YTHENS10:GOT0585
550 REMD:IFPNT#E0B0E10E10MIDS(FS,1,1)*".THENIFI?>THENG2SELSE565
555 REMD:IFP#FS#E0R2E10E10FMSDORGS,1)*".GUMH301?>THENG2SELSE565
560 NEXT:IFP#THENG2SELSE6E#S#SPGES10#E15C00B50E1#7SPGES16#E1565
565 BS=RETS#FS;E#1#SEL#E#M#S#1#E#0#M#G#2#SEL#9#1#SPGES16-L)565
570 BS=HID#FS;E#1#3#EL#E#M#S#1#E#0#M#G#2#SEL#9#1#SPGES16-L)565
575 IS=HYZ#0E#E#1#0#E#IS#HID#(RS,1)1#E#IF#K#?":THENS#IS#YS:Z=1
580 IF#S#?":THENGZTHENG2S#HID#(RS,1)1#E#IF#K#?":THENS#IS#YS:Z=1
585 NEXT:FS#LEN#SPCES#S#LEN#S#1)1#E#IF#K#?":THENS#IS#YS:Z=1
590 FOR#E#1#0#E#IS#HID#(RS,1)1#E#IF#K#?":THENS#IS#YS:Z=1
595 IF#S#HID#(RS,1)1#E#IF#K#?":THENS#IS#YS:Z=1
600 IF#S#HID#(RS,1)1#E#IF#K#?":THENS#IS#YS:Z=1
605 NEXT:NEXT#(RS,1)1#E#IF#K#?":THENS#IS#YS:Z=1
610 GOSUB#PRINT#;" FILE IS NOT FOUND":RC=1:RETURN
615 IF#S#HID#(RS,1)1#E#IF#K#?":THENS#IS#YS:Z=1
620 GOSUB#PRINT#;" IF#E#(IS#NOT#OG#E#TYPE#):RC=1:RETURN
625 GOSUB#PRINT#;" IS#D#D#FILE#NAME#:#CP#:#RETURN#RETURN
630 GOSUB#PRINT#;" C#E#D#D#:#RETURN#":RC=1:RETURN#RETURN
635 GOSUB#PRINT#;" IS#D#D#FILE#NAME#:#CP#:#RETURN#RETURN
640 REMD:SSON#R#S#THENS#RES#NEXT
645 IF#R#S#ON#R#S#THENS#RES#NEXT
650 IF#R#S#ON#R#S#THENS#RES#NEXT
655 REMD:SET#H#C#E#R#T#O#N#(ON#R#Z#V#K#H#A#P#U#T#O#R#E#L#I#M#B#R#G#M#E
660 @#R#O#C#T#O#N#?:(RETURN ON OK)":KYS=INPUT#(1):PRINT#RESUME

```

clearing does not have a bright future in the games market.

Expansion

The Panasonic JD range of personal computers is not designed for expansion. There are three serial ports that can be used to add printers and modems or to turn their personal computer into an intelligent terminal of a larger system.

Rather than designing a computer that can be expanded, Panasonic decided to produce a range of similar computers. The review machine was the smallest in this range and the only one that does not come with 56K of RAM as standard. A memory expansion kit should be available soon. The second machine in the range called the JD-740 is similar to the JD-700 except that it has double density, double sided disc (580K bytes capacity). The JD-800 comes with 8" single density single sided discs (512K bytes capacity) while the current top of the range has double density double sided full size discs (2 megabyte capacity). Panasonic are expected to announce a hard disc 900 series computer.

The design philosophy for the hardware fortunately does not carry over to the software. Since Panasonic have put CP/M on their system, the full range of system and application software available under CP/M can be implemented on the Panasonic range of personal computers. CAP Microcobol should be available soon after the launch.

Documentation

Manuals for CP/M, BASIC and technical information were provided with the computer. The standard CP/M manuals are incorporated within the Panasonic CP/M manual as chapters, preceded by a chapter entitled 'A guide to Panasonic CP/M'. This first chapter contains an overview of the system and details of any deviations that Panasonic CP/M exhibits compared with standard CP/M.

Altering the rest of the chapters in the appropriate places to include this material would have been a preferable approach. Whereas I've not previously had difficulty locating specific details when using the original collection of CP/M manuals, I found using the single Panasonic manual awkward. Page numbers start from 1 in each chapter and though there is a brief table of contents (useful for finding the order of the chapters but not much more), there is no index.

The BASIC reference manual, an improvement over the CP/M one, is Microsoft's standard manual with additions interspersed for the special Panasonic language features. Unfortunately the detailed table of contents lacks page numbers but there is a good index.

The third manual, called "OEM Manual JD-700", is written in fairly poor (but understandable) English by Panasonic. It aims to describe the hardware components down to chip level for maintenance and customization purposes. Sufficient information including diagrams and tables is provided for altering such system attributes as screen format or block size for data transfers. Full instruction sets are included for the 8085 and the programmable controllers. The manual is paginated and has an adequate table of contents.

As the cost of getting manuals decently translated, paginated and indexed must be minor compared with that of hardware development, I can only assume that manufacturers underestimate the importance of well presented, easy to use documentation.

PRICES

JD 700 32K £3985
 JD 700 56K £4125
 JD 740 56K £4500
 JD 800 56K £4750
 JD 840 56K £5500
 The memory expansion kit for the 32K JD 700 is not yet available.

Conclusion

The Panasonic JD 700 is a well designed self contained small business computer and, although much attention has gone into the hardware, the same cannot be said of the software. With CP/M for its operating system, a large range of system and application programs can be transferred to it, but prior to the machine's general release they haven't been put on. As it stands, the user has the choice of either CP/M or Microsoft BASIC. Although the hardware seems most suitable, the software has not been set up for screen editing. However, because the machine is attractive, compact, robust and convenient without much software it will probably end up as the basis for a variety of turnkey business systems where its uncompetitive price can perhaps be disguised in the overall cost.

At a glance

FIRST IMPRESSIONS	
Looks	****
Setting Up	****
Ease of Use	****
HIGH LEVEL LANGUAGES	
BASIC	****
COBOL	N/A
FORTRAN	N/A
PASCAL	N/A
System Software	***
PACKAGES	
Business	****
Education	N/A
Home	N/A
PERFORMANCE	
Processor	***
Cassette	N/A
Disc	***
Peripherals	N/A
EXPANDIBILITY	
Memory	***
Cassette	N/A
Discs	N/A
Bus	N/A
COMPATIBILITY	
Hardware	**
Software	****
DOCUMENTATION	
	**
VALUE FOR MONEY	
	**

- ***** excellent
- **** v. good
- *** good
- ** fair
- * poor

Benchmarks	
1	2.8
2	9.1
3	24.6
4	24.7
5	26.2
6	43.9
7	69.7
8	11.8

Disc tests	
1	1.7
2	45.8
3	42.1
4	44.1
5	40.4



VIVA LAS VEGAS!

Where is the future in microcomputing? Julian Allason of Petsoft reports on a voyage of discovery that led him, via the giant Consumer Electronics Fair in Las Vegas, to the dustbins and back yards of Palo Alto

Holding the Consumer Electronics Fair in Las Vegas must have seemed like a good idea at the time. Four days later as 55,000 excited electronics retailers flew off home, Las Vegas was less sure. In Mob circles enquiries were said to be afoot into just whose bright idea it had been to invite so many computer experts into the casinos in the first place.

Nevada's fledgling anti-noise lobby found themselves in some disarray also. Vegas is hardly a haven of peace and tranquility at the best of times, but the CES had raised noise pollution to astonishing new levels.

Not all of the din was man-made. Visitors to the cavernously vast convention centre were assailed by the uninflected babble of myriad synthetic voices.

It has to be admitted that whilst artificial speech is perfectly comprehensible, the present level of development leaves a good deal to be desired from an aesthetic point of view. Quasar's talking calculator was described as resembling a dalek with a Swedish accent. Not surprisingly Texas Instrument's Language Translator had a certain cowboy drawl, the voice patterns having been modelled on those of a Dallas disc jockey.

The Translator is rather impressive, pronouncing and displaying over three hundred phrases and 3,000 words in Spanish, French, German and English, according to which module is plugged in. The handheld device is now on sale in the United States at \$300 including earplug and mains adaptor. Sharp's talking calculator had speech recognition as well, responding to twenty-two words and three different voices.

Randy Robots

A passing robot motioned towards Sanyo's talkative calculator and confided that it had once been out with one of them; "All talk and no action," it complained.

It seems that just about everything will be having its say in the not too distant future. One company had a refrigerator which noisily advised against "snacking" after midnight. Even the normally sedate Toshiba showed voice-activated hi-fi.

The distinguished software consultant Gregory Yob described his nightmare of pulling up at a red light and having the car stereo argue with the instrument console. When Windert Inc. release their \$99 talking watch, no doubt it will join in too.

Peripheral Paradise

Surprisingly it was in computer corner that visitors gained a brief respite from the clamour of synthetic voices. Relative peace reigned as Apple demonstrated their new Graphics Tablet. A shape traced on the 11" x 11" Mylar overlay is converted to digital values and the image displayed on the Apple's video monitor. It can also be stored on disc for later processing.

Resolution was 167 points to the inch and scaling user selectable. A reducer function allowed the composition of quite detailed figures. Other functions could be activated by touching a number of menu boxes at the top of the tablet. I found the system surprisingly fast considering that the control program and functions are written in BASIC.

The Graphics Tablet is to retail at \$795 complete with interface card,

connecting cable, ROM firmware and software on disc. Minimum system requirements are 48K of RAM, Applesoft BASIC and disk II.

And cheap too

A much less expensive accessory was the Presto Digitizer which enables PET, Apple, and Atari computers to recognize hand printed letters and graphics characters. Developed by Dr. David Thornburg of Innovision Inc., the digitizer consists of a copper tablet divided into seven oblong shapes. As each character is inscribed on the surface the stylus passes over them in a different order. The handwritten characters are converted to digital values and passed to the screen where they appear as alphanumeric or graphics characters. U.K. release of the Presto Digitizer is imminent and retail price is expected to be around the £40 mark.

Hot Computers

Considerable trade interest was expressed in Ohio Scientific's Challenger 4P colour computer. For a remarkable \$698 American customers are being offered a cassette based system with 8K BASIC in ROM and 8K bytes of RAM to plug into their TV sets. The 4P I saw featured 16 colours in both alphabetic and graphics, 32 rows by 64 columns of upper and lower case with an effective screen resolution of 256 x 512 points.

For prospective British purchasers the hook, as ever, is that the computer has been designed around the American 525 line NTSC colour TV system. An Ohio salesman claimed that the company had a 625-line PAL version in the works. In this connection it is perhaps worth noting that neither Texas nor Atari have succeeded in bringing out

European versions at time of writing, and Ohio may encounter similar difficulties.

Needless to say the Challenger 4P has a 200-20KHz programmable tone generator for voice (and music) generation. The provision for I/O is generous, including as it does two 10-key pad interfaces, two 8-axis joystick interfaces, a printer interface (which was not wired to a connector), and an AC remote control interface. Expansion up into 32K of RAM and two mini floppy drives is allowed for. The speed was impressive and claimed at three times that of the Tandy TRS-80.

HP Source

The real blockbuster was the launch of Hewlett Packard's desk top micro — the HP 85. This ultra compact computer incorporates a 5" 32 column by 16 line screen matching thermal printer and a tape cartridge drive. The whole package weighed no more than 20lbs and measured a modest 18x6½x16½ inches, approximately.

Hewlett Packard will probably not be thanked for introducing a new tape format. However, the cartridges store up to 195K bytes of program or 210 of data which may be accessed and loaded at "high speed" via a tape directory. In practice it took nearly half a minute to locate and load a 2K program. However, floppy discs and other peripherals are promised for the future.

For a hefty £1950 you get a system based on HP's own 8-bit CPU, with 16K bytes of RAM, expandable to 32K. Cartridges retail at £9 each. As might be expected from Hewlett Packard the BASIC is fast and very extensive with 42 predefined functions and 12-digit accuracy. Notable were the flexible high resolution graphics handling and a useful software security feature capable of protecting programs and data from listing, editing or copying. In graphics mode 256 x 192 points can be addressed on the screen or printer. Two buffers store last text and last graphics displays making it possible to switch between the two without loss of data. This is a *very* carefully thought-out computer. Biggest minus is that assembly language programming is not possible. A new PET it is not.

Peek-a-Boo

Most of the other microcomputer manufacturers maintained surprisingly low profiles, Tandy to the point of invisibility. Commodore teased everyone with a 'now-you-see-it, now-you-don't' display of its superb new large screen model. Already dubbed the 'Super-PET' by PRINTOUT magazine, it has a 12" 80 column screen and an improved BASIC. Although no formal announcement was made, dealers seemed confident that the new range would at the very least maintain Commodore's global number two position.

With the remaining micro houses like TI and Atari showing only new disc drives and modems for introduction at 'some time in 1980' the silence was deafening.

The impression conveyed to dealers was that the era of hyperactive development was over. The market was now safely in the hands of the big boys, with

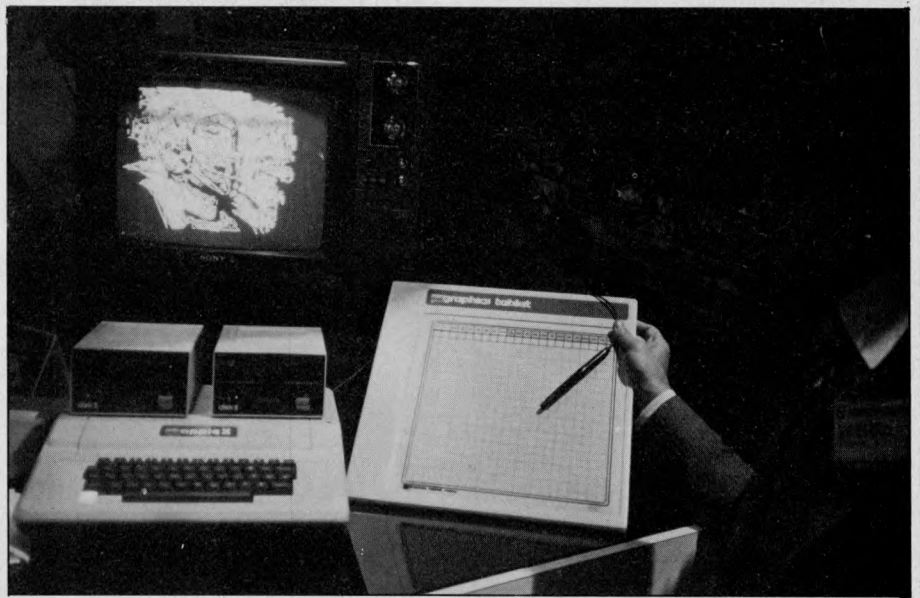

Above: Apple's new Graphics Tablet — fast response and useful facilities. Left: Julian and friend! Below: Xymec printer — prettiest peripheral, but is it really an Olivetti? Bottom: Boxing clever with Mattel — best colour graphics yet.

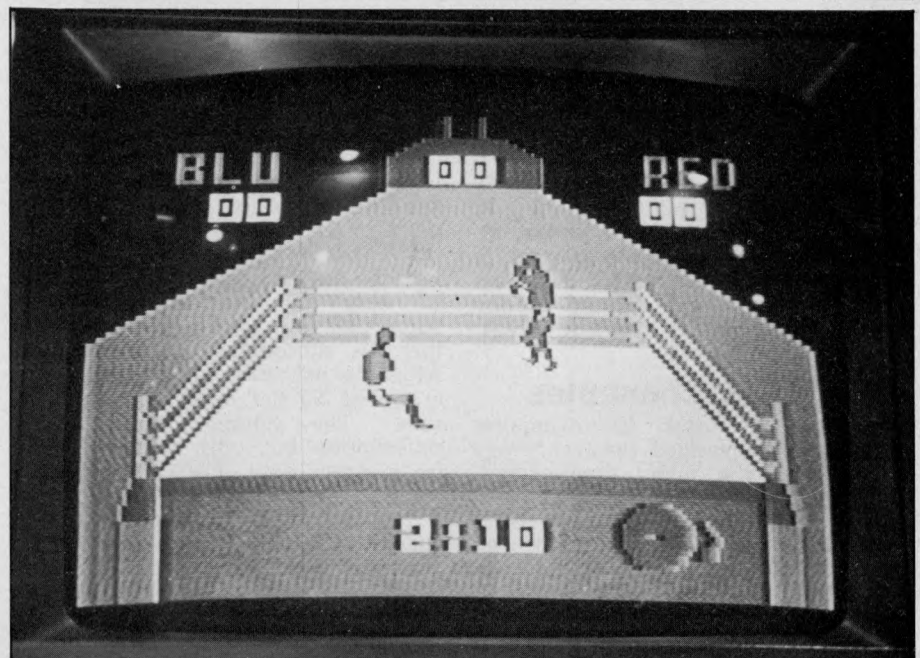
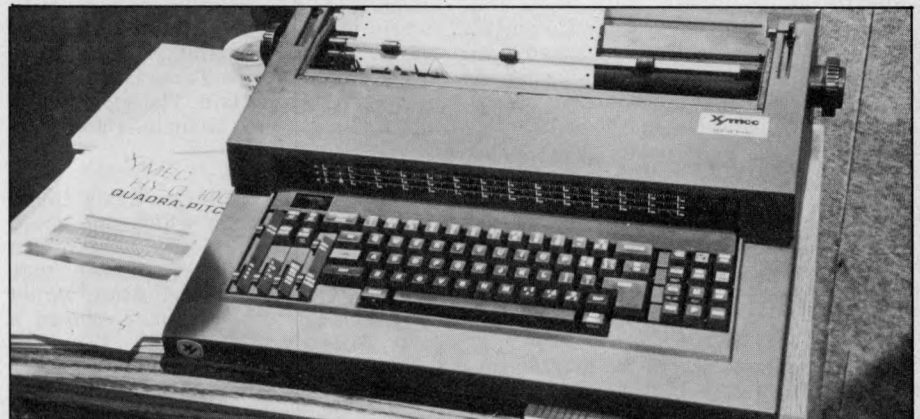



Left: Commodore's acoustic modem will let PETs converse over long distance telephone. Below: Common Sense security system — PET monitors alarm and displays security zones on screen.



most of the pioneers gone to the wall. From now on, the argument ran, controlled marketing strategy would be the order of the day. These at least were the conclusions reached by many CES visitors as they played the slot machines in the airport departure lounge.

Palo Alto Pilgrimage

If such really was the case, then it was a mighty reversal indeed. Both Apple and TRS-80 were born in garages. Could the situation really have changed so radically in two and a half years? A quick visit to the backyards and garages of Silicon Valley seemed called for.

Almost all of the innovators of the microcomputer world have outposts in that narrow spur of land which protects San Francisco from the Pacific Ocean. Five days on the peninsula convinced me that the era of rapid development is far from over.

Super Stringy

Developments to watch for include the Stringy Floppy, a budget priced high speed data storage system that will make the cassette drive obsolete. Using inexpensive tape 'wafers' like a miniature cartridge, which can store up to 150K bytes, the Stringy Floppy is as reliable as mini-floppy disc, nearly as fast, and a third the price. Manufactured by Exation Inc., a version configured for the SWTPC 6800 is already on sale, and I was shown a prototype running on the PET at an independent laboratory. With Microsoft developing a specially extended BASIC to handle data files and fast access, the Stringy Floppy looks set to make a major breakthrough.

Look Ma, no phonemes

One of the major Microcomputer manufacturers revealed the technology it currently has under development. Inevitably, one of the projects related to speech synthesis, in this case, of a somewhat higher order than had been demonstrated in Las Vegas. As each key on the keyboard was depressed it identified itself orally. For those who desire never to have to study phonetics

the system is a revelation. Words typed on the screen in normal English are rendered into clear inflected English.

This is achieved by referencing each word entered to a disc based dictionary of some 700 oft-used words. Instructions are then given to the synthesiser to enable it to generate the correct phonemes. If the word entered is not found in the dictionary it is enunciated phonetically according to certain key rules of pronunciation. This phoneme programmability approach is in direct contrast to Texas Instrument's digital storage method. The advantage is that it allows words to be inflected.

Tender Touch

Another prototype device was a touch sensitive screen upon which one could draw using a finger. It would also return the X, Y co-ordinates of the spot touched. One useful application would be direct menu selection. I played a game of touch Tic Tac Toe and promptly lost to the computer.

Throughout the visit to the Bay Area, I was asked: "Are you on the Source?" At first I took the reference to be to one of the quasi-religious California cults which spring up every few weeks. The Source turned out to be one of the two major communications networks now linking microcomputer users throughout the U.S. with large mainframe computers and with each other.

More Source

For the astonishingly low hook-up fee of only \$9 the other network, MicroNET, will grant a microcomputer user his subscription to the system. After this once-only charge, access costs a modest \$5 per hour for connection time. The Source has a \$100 subscription but only \$2.75 an hour for connect time. The only accessory required is a standard 300 baud modem.

MicroNET has local rate telephone charges from major cities and reduced charges from over 100 others. Subscribers get 128K bytes of free storage on the mainframe and can use the system during the off peak hours of

6pm to 5am and all day weekends and holidays.

The microcomputer owner can use the powerful mainframe processors in BASIC, Fortran, Pascal, APL and a number of other languages. The software includes personal, business, educational and games programs, including networking multi-player games. Software can also be purchased and down loaded to your personal computer. All charges are debited directly to the subscribers credit card account.

Micromail

Perhaps the greatest potential lies in the field of electronic mail. MicroNET subscribers can send messages or software to other users. Tom Williams, editor of the Intelligent Machines Journal, told me that he is already receiving stories via The Source. A UFO reporting service is also operating.

Source subscribers also have a nationwide toll-free computer based answering system available to them. They can send or receive electronic mail messages when a terminal is not available. Users simply dial a toll-free number from anywhere within the U.S. and dictate 'Voicegram' messages over the telephone. These can be retrieved from any terminal, communicating word processor or microcomputer, using one of these communications networks.

Voicegrams can be up to 100 words long and are forwarded within an average of 15 minutes for a cost of \$1.25 plus the normal connect time charge.

The Future

The sudden arrival of electronic mail has produced some amusing side effects. The U.S. Post Office is currently locked in litigation with the Federal Communications Commission in a battle for jurisdiction. While the bureaucrats squabble the networks grow. Micro-networking is an idea whose time has come. Now it is just a matter of time before it makes a satellite assisted leap across the Atlantic.

All Systems Are Not Created Equal

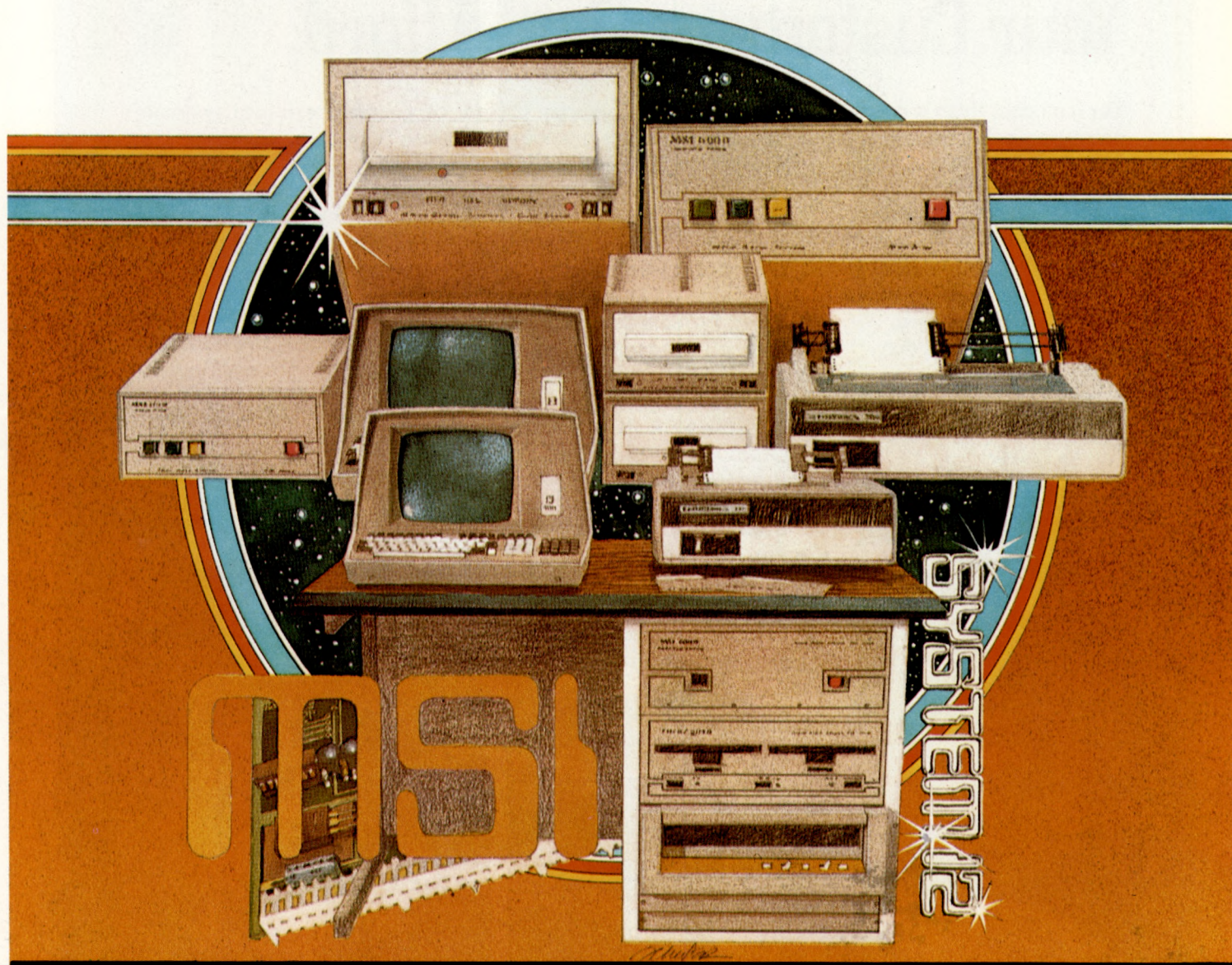

Your computer application is unique. It differs from all others. It is because not all applications are equal that MSI has developed a variety of computer systems.

At the heart of every MSI System is the powerful MSI 6800 Computer, one of the fastest and most versatile available. Depending on the System you select, the MSI 6800 has from 16K to 56K of RAM. Mass memory storage in MSI Systems range from 315K bytes in the System 1 to over 10 megabytes in our most powerful System 12.

In addition to the computer and memory subsystem, MSI Systems include a CRT terminal and high speed character printer. The System 12 is housed in a compact desk unit.

As with hardware, computer software is not always created equal. Since there are a myriad of programs available, MSI offers a choice of Operating Systems for use with your MSI Computer System. Of course, our favourite is MSIDOS, but we offer the powerful SDOS operating system as well. All MSI Systems will support the other software products associated with each operating system.

MSI also has a variety of software programs including a Multi-User Basic program capable of supporting up to four users.

MSI Systems are currently being used in a broad spectrum of personal, scientific, educational, professional, and business situations. In addition to our Systems, we

can supply you with individual components for personal and OEM use. All MSI System components are available, some in kit form.

Write or call us for more information about MSI Systems and products and the name of your nearest MSI dealer.

seed

Strumech Engineering
Electronic Developments
Portland House,
Coppice Side, Brownhills,
BRO 4321 Telex: 335243

DYNABYTE, The Business Computer System Your Customers Can Afford.

For less cost than a new company car, your prospects can own an expandable computer system that will fully automate their business. And you can teach their bookkeeper to run the system with just a few hours of training, on-site, in a single day.

Field Tested Programs: Over 600 Dynabyte systems are in use across America generating timely reports, P & L Statements, Payroll, Accounts Payable, Accounts Receivable, Inventory Control, Data Base Management, Word Processing and customized programs. Dynabyte supplies high level languages for specialized needs including BASIC, FORTRAN, COBOL and PASCAL.

Expandable Diskette Memory: Your customers can select from 5¼" or IBM compatible 8" floppies with compact single station memory storage from 650,000 words up to 2 million words;

or multiple terminal systems with 10 million word storage capacity. Users can start small and then add more memory and multi-tasking functions as needed by their growing business.

Price, Performance, Service: Dynabyte offers the business computer system at prices customers can afford, with proven reliability and modular construction allowing overnight service in most areas.

DYNABYTE

UK/EUROPE INTERNATIONAL LTD.
25 PARK ROAD, FALSGRAVE, SCARBOROUGH,
N. YORKS YO12 4AH
Telephone 0723-65559 73338 Telex 52317



Cassette input port

Unlike some microcomputer systems available at present which allow the transfer of data to and from a cassette recorder, the Apple II and ITT 2020 depend virtually entirely on software for analysing the output from the cassette when reading data, and generating a suitable signal for it when writing data. This means that the data is available to the processor in virtually the same form as it is recorded on the tape, with only a Schmitt in between to "clean" it up a bit; it's not buffered off from it by a p.l.l. or frequency comparator. This means that one can perform various functions on the signal fed into the data input (which of course, doesn't necessarily have to have come from a cassette recorder. This is, however, probably the best way to start as it will already be hooked up).

Period measurement

By deriving a means to measure the frequency or period at this point, the value obtained can be used by other programs for control or effect . . . or anything else.

In this case the result determines the colour of a pattern displayed in the lo. res. graphics mode. The number of other applications of the technique are only limited by the user's imagination.

Whistling is chosen as the best input (when using a microphone) as it gives a purer waveform than, for instance, voice input. Hence results are more reliable (see later, however).

Software

The technique produces a number proportional to the period of the incoming signal by starting a counter at a 1 to 0 transition and stopping it as soon as a 0 to 1 transition is encountered.

One sample of the period measurement would probably do on its own if the signal to be measured were clean (a pure sinewave or squarewave for example), but there are bound to be various discontinuities or extraneous noises involved too and these will almost inevitably cause errors.

To get round these problems not just one, but sixteen samples are taken and the results stored in memory.

Averaging

In the next stage all the sixteen samples are added together, the result being stored in memory (two bytes). This value is then divided by sixteen to yield the average value of all the samples. This has a far greater chance of being representative of the actual period than the value obtained from a single measurement.

Initially this part of the program was done in BASIC with only the period measurements in machine code; but the BASIC section proved too slow for most applications and so the averaging is now included in the machine code section.

The sixteen samples are stored in memory locations 0300-030F. Locations 0310-0325 contain the subroutine which actually carries out the period measurement, whilst locations 0350-037F is the averaging program. The control program (0330-0348) calls

WHISTLE UP A COLOUR ON YOUR APPLE II/ITT 2020

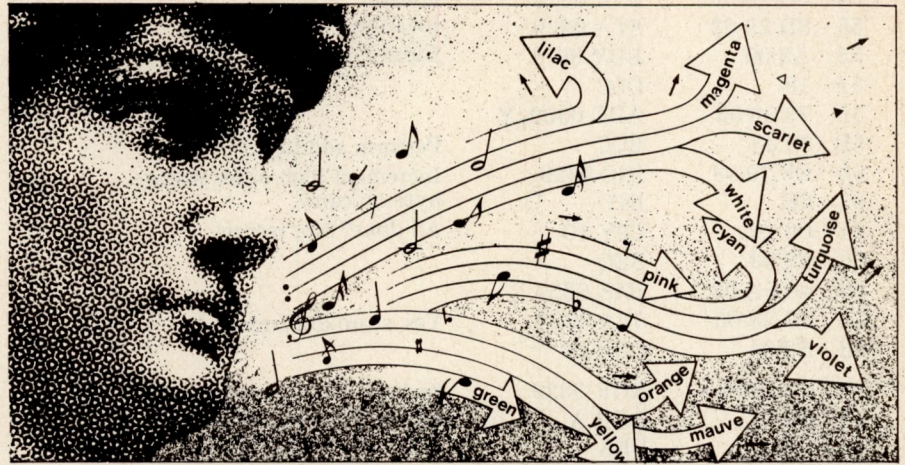

Using only the cassette data input port of the Apple system (plus a microphone/pre-amp.) the software described here provides a technique to generate effects or alter program direction as a result of the user whistling at different frequencies. R. W. Lawrence BSc explains. . .

up the above two subroutines, and also determines the number of samples to be taken and where they are stored.

Locations 0328 and 0329 hold the low and high order bytes of the sum of the samples, and the final average value is stored in location 038F. This can be examined when in BASIC by PEEK-ing (911).

Source code

The programs are fairly self-explanatory. The division by sixteen is per-

formed by a right shift operation done four times, from location 0329 through the accumulator. Since none of the period samples taken could be greater than 225_{10} , it follows that the average must be less than this too — hence the result must fit into the accumulator.

Basic program

This program puts the colour display up on the screen, and after calling up the machine code program, varies the colour of the display depending on the

Listing

0300			
01			
02			Storage locations
03			for period measurements
04			
0F	A		
0310	A9 01	LDA 01	Initialise flags and counter
12	A2 00	LDX 00	
14	2C 60 C0	BITC060	
17	30 FB	BMI	Zero yet? No, test again
19	E8	INX	Yes: Increment X
1A	2C 60 C0	BIT C060	One yet? No? Go back and inc. X
			Yes: Go on
1D	30 03	BMI	
1F	4C 19 03	JMP 0319	
22	8A	TXA	Transfer X to A and store
23	91 FA	STA (FA), Y	final count in relevant
25	60	RTS	location. Return.
0330	A9 00	LDA 00	
32	85 FA	STA	Set up pointer
34	A9 03	LDA 03	
36	85 FB	STA	

38	A0 00	LDY 00	Zero counter for no. of samples
3A	20 10 03	JSR 0310	Call subr. for period measurement
3D	C8	INCY	
3E	C0 10	CPY 10	16 ₁₀ samples taken yet?
40	F0 03	BEQ	No, repeat. Yes, finished.
42	FC 2A 03	JMP 033A	
45	20 50 03	JSR 0350	Call averaging subr.
0348	60	RTS	Return to Basic prog.
0350	A9 00	LDA 00	Clear
52	8D 28 03	STA 0328	storage
55	8D 29 03	STA 0329	locations.
58	A0 00	LDY 00	Clear Y reg.
5A	18	CLC	
5B	79 00 03	ADC 0300, Y	
5E	90 03	BCC	Perform additions
60	EE 29 03	INC 0329	Increment high order storage
63	C8	INY	byte on carry
64	C0 10	CPY 10	All done? No, return
66	F0 03	BEQ	
68	4C 5A 03	JMP 035A	
6B	8D 28 03	STA 0328	Yes, store low order byte
6E	A2 04	LDX 04	
0370	6E 29 03	ROR 0329	Perform ÷ 16 ₁₀ process by 4
73	6A	ROR A	right shift operations
74	CA	DEX	through accumulator
75	E0 00	CPX 00	
77	F0 03	BEQ	4 completed? No, return
79	4C 70 03	JMP 0370	
7C	7D 8F 03	STA 038F	Yes, store result
7F	60	RTS	Return

Basic program listing

```

200 GR
205 CALL 816: W = PEEK (911)
220 IF W < 11 THEN W = 11
230 IF W > 110 THEN W = 110
240 COLOR = INT ((W - 3)/108 * 15)
242 R = RND(1): IF R > 0.5 GOTO 245
243 FOR N=1 TO 19 STEP 2: HLIN(20-N), (20+N) AT
(20+N): VLIN(20-N), (20+N) AT (20+N): HLIN (20-N),
(20+N) AT (20-N): VLIN(20-N), (20+N) AT (20-N)
: NEXT
244 GOTO 205
245 FOR N = 19 TO 1 STEP -2: HLIN (20-N), (20+N)
AT (20+N): VLIN(20-N), (20+N) AT (20+N): HLIN
(20-N), (20+N) AT (20-N): VLIN(20-N), (20+N)
AT (20-N): NEXT
250 GOTO 205

```

Generator listing in M/C code

038F			Location for pitch data
0390	A9 08	LDA 08	Load A with duration
92	8D 30 C0	STA C030	Toggle Speaker
95	88	DEY	
96	D0 04	BNE	Decrement X until zero and
98	E9 01	SBC 01	toggle speaker each time
9A	FO 11	BEQ	round. Decrement Y too, but
9C	CA	DEX	only decrement A by 1 after
9D	D0 F6	BNE	255 ₁₀ Y decrements.
9F	AE 8F 03	LDX 038F	
A2	48	PHA	Variable delay in pitch loop
A3	A9 03	LDA 03	to tune final o/p frequ. to
A5	E9 01	SBC 01	match that coming in
A7	D0 FC	BNE	
A9	68	PLA	
AA	4C 92 03	JMP 0392	
AD	4C 30 03	JMP 0330	Back to main prog.

frequency of the incoming signal.

The system assumes the signal has a frequency range from about 400Hz to about 2KHz, this being considered a reasonable range to whistle over. Any measurement yielding values that are outside this preset range are "clipped" into it by lines 220 and 230. Line 240 normalises the measurement into an integer between 1 and 15: ready to set the colour of the pattern to one of the fifteen possible on the system.

Line 242 makes the display slightly more interesting by randomly selecting the "tunnel in" (line 245), or the "tunnel out" (line 243) subroutine. These two subroutines change the colour of about ten concentric squares, the only difference between them being the STEP value which selects motion inwards if -2, and outwards is +2.

Looping

As it stands, the processor remains in a loop in the machine code program awaiting any input to the cassette input port. Whilst in this loop it cannot accept data entered from the keyboard - or anywhere else - only, in fact, from the cassette input. Control can be returned to the keyboard via the usual RESET; control C. If desired this can be remedied by putting in a "look at keyboard to see if the key has been depressed" type of programme between lines 0314 and 0317, and jumping out of the loop if it has. This was omitted to keep the number of machine cycles within the loop to a minimum and thus allow the highest possible frequencies to be measured.

Other applications

The technique has been used successfully in other applications (the one described here was really by way of an example) such as in a software frequency of the incoming signal against time; and, if suitably modified, in speech analysis and synthesis.

A reciprocal machine code program could be added. This would form a generator (using the internal speaker) producing tones of the same frequency as those measured by the above arrangement when presented with the same data. Thus the Apple could "whistle" along with you - albeit rather roughly as it would have to stop every so often to see what you're whistling.

A suitable machine code generator program is also given. It's a modified form of the one listed in the Apple II Reference manual, except that the duration is preset (byte in location 0391) and also a "tuning" factor is added to make sure it "whistles" what it "hears" (using the terms euphemistically). Lines 03A2 - 03A9 perform the latter. Increase the value at 03A4 to flatten the generated frequency for a given input, and reduce it to sharpen the generated frequency.

Linking up

The generator program can be linked in to the analyser program as follows: Line 0348 changes from 60 (RTS) to: 0348 4C 90 03 (JMP 0390).

P.S: If you can't whistle, you'll just have to learn to hum sinusoidally.

COMPUTER ANSWERS

Each month Sheridan Williams and his panel of consultants answer readers questions. Topics may be hardware — from kits to mainframes, or software — from differential equations and statistics to file handling or sorting; the choice is yours. Send your questions direct to Sheridan Williams at 35 St Julians Road, St. Albans Herts.

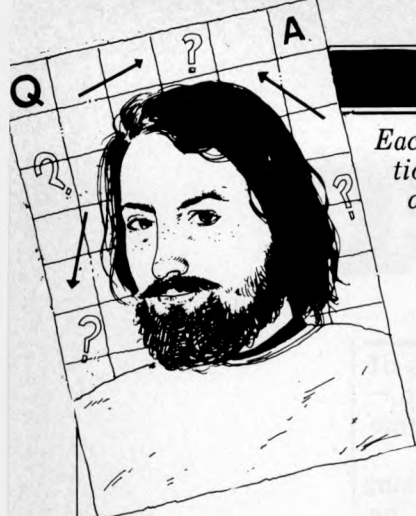

Either/or

I am presently trying to decide which of two computers to purchase, either the Apple II or the CompuColor II.

As you most probably will already have realised, I am looking for a computer with good colour graphics and a good information store (floppy system). Could I have a list of pros and cons on both computers?

Do you know if Apple is working on a Mk III and when it will be released? And, finally, could you please tell me the difference between the Apple II and the ITT 2020?
Mr. M Randall, Bury St. Edmunds, Suffolk.

As you imply, when choosing between the Apple II and the CompuColor II it's very much a question of pros and cons rather than a "best buy". The balance is going to depend on which features are of most importance to you.

As you already know, Apple II and CompuColor II are the only two real contenders in their class for colour graphics. Both also aim at being general purpose micro-computers, and both have floppy disc drives available.

So how to choose between them? That, I think depends on where you wish to place the emphasis — colour graphics, or general purpose computing ability. Look at some of the differences between the two machines:

Once you have added a disc drive to Apple you have upwards of 110K bytes on-line, and a flexible system which will let you add other drives. CompuColor comes with a built-in single drive, but it gives less than 52K bytes of storage. A second identical drive can be added, but that's all.

Apple can readily be interfaced to a wide variety of peripherals, not so CompuColor. Apple is about 50% faster. Apple can LIST from one specified line number to another — CompuColor can only do a complete LIST from beginning to end. There is a lot of software available in this country for Apple — not much (as yet anyway) for CompuColor. And there is a surprising range of firmware

for Apple — from light pens to speech input and output.

CompuColor displays 32 lines of 64 characters — Apple only 24 lines of 40 characters. CompuColor has consistent colours. There are places on the screen with Apple where a line of a specified colour just does not appear! The trouble seems to be that Apple uses a colour TV set for its display, and the compromises involved with the UK television system are not entirely happy. CompuColor comes with its own built-in colour monitor, and is largely free of these problems.

So there, in my opinion, you have it apart from the fact that for a single drive system with 32K of memory, CompuColor could be up to £200 cheaper. It's all a question of where your preferences lie — if colour graphics is the most important, I'd think long and hard about a CompuColor — if you want versatility, Apple certainly scores. Do try to see both in action before choosing.

The closest we are right now to an Apple III is the Apple II EUROPLUS, and its main difference from the Apple II is an "Autostart" ROM. This enables the computer to start RUNNING a program as soon as you turn it on and includes improved edit facilities.

Turning now to the differences between Apple II EUROPLUS and ITT 2020, the extended BASICS (available in ROM) seem to differ mainly in their handling of high resolution graphics. This shows up most with the plot grid which is 280 x 192 on the Apple, but 360 x 192 on the 2020. While a plot of, say, 50 x 50 on the Apple is square, on the 2020 it's a rectangle. The colours on the 2020 are somewhat purer and richer and the machine does not have Autostart, although it will accept an Apple Autostart card. It has, however, overcome the problem of the closeness of the RETURN and RESET keys on the Apple. On the 2020 you have to hold down CONTROL before RESET will work. Costs for the two machines are very similar.

Once again, I would urge you to see the machines in action, side by side, if at all possible.

Apart from the August 1978 review of Apple II in

PCW, you will find more on Apple II in the January 1979 issue, and a "Bench Test" of CompuColor II in the September 1979 issue.

P. McIlmoyle.

Vetting a pet

I wish to buy a secondhand PET (no discs or printer but with as much memory as possible). How do I test it to ensure that I am not buying a load of rubbish? The tests would have to be carried out at the current owner's home and should take no more than 30 minutes.

I have used PETs before and found some software bugs I would like to eliminate (e.g. pressing return only, after an INPUT request and the system crashes). Having extensive assembler, operating system and compiler experience, I feel this is within my capabilities. Is there a simple and practical guide to micro hardware for people with only software experience? Also is there anywhere I can obtain listings of the system software and BASIC interpreter?

T. Edwards, Chalfont St. Giles, Bucks.

The Commodore PET is an excellent buy as a "switch on and go" microcomputer, and there is no reason to suppose that a secondhand one will be a waste of money. The critical stage of any electronic equipment is the first few months of its life. Generally, any faults will become apparent during this period. The PET is reasonably trouble free after this term.

There are a number of points to look for when buying a secondhand machine. The cassette drive is the most likely part to give trouble. This can be a simple fault — such as a dirty or poorly aligned tape head — or, more seriously, there may be problems with the power supply. The power supply is not very well regulated on the PET and the earth not very secure, which gives problems reading tapes. Faults of this nature can usually be seen as a wobble on the screen. The easiest way to test the tape unit is to load a few program and data tapes; if they load without error, you can assume it's working correctly. You should check that the RAMs are okay; there are a number of tapes available which will test them and these should be obtainable from any Commodore dealer. It's important that you don't just rely on the FRE(X) function to test the memory as it's not always indicative of a functioning memory.

The external ports are a little more difficult to test. It is possible to check them by "poking" the PIA output registers and measuring the voltage on the output connections, but if you don't intend to add a printer or discs, there's no need to bother.

There are a number of bugs in the PET software, some of which are cured by the new ROM machines, but usually it's far better to learn to live with them, rather than overcome them with machine code routines. Remember that BASIC is in ROM and is not easily changeable.



"Looks like PET expansion to me!"

COMPUTER ANSWERS

Incidentally, the one you mention doesn't actually crash the system, it just reverts to BASIC from program control; it's also very easily cured by ensuring that the cursor is positioned over a character (e.g. INPUT "sp sp sp ↵ crl crl crl";X\$). Here, sp = space and crl = cursor left.

There are a number of publications, some available from Commodore which will assist in using the system software for advanced programming, and also for the hardware. A trip to a technical bookshop or a glance through the book suppliers in PCW will be worthwhile as there are a large number of publications available dedicated to the 6502 IC (the microprocessor used in the PET).

Mark Wratten.

Pointing the way

I have a program that will put a straight line through a set of points and allow me to make a prediction based on that straight line. For example, given the population of the world over the last 100 years, I could predict the future population with a fair amount of accuracy. Suppose that the set of points is nowhere near a straight line, what do I do? Is there a way of putting a curve through the given points?

T. Williams, Croydon, Surrey.

Yes, there is, it's called curve fitting, and a curve is put through the set of points so as to give the best fit; it's not an exact fit as there will always be a small amount of error. Provided that there are not too many transcription errors, what follows should be useful. Ask someone with at least A level maths to help as it would take many pages to put the following formulae into words. I have replied personally to the writer, but if other people are interested I'll turn this into an article for future publication — please write and let me know. To fit a straight line of the form $y=ax+b$.

$\Sigma y = a\Sigma x + nb$
where n is the number of pairs of points

$\Sigma xy = a\Sigma x^2 + b\Sigma x$
now solve for a, b and c in the equation $y=ax^2+bx+c$

To fit a quadratic you would use

$\Sigma y = a\Sigma x^2 + b\Sigma x + nc$
 $\Sigma xy = a\Sigma x^3 + b\Sigma x^2 + c\Sigma x$
 $\Sigma x^2 y = a\Sigma x^4 + b\Sigma x^3 + c\Sigma x^2$
now solve for a, b and c in the equation $y=ax^2+bx+c$

You can easily extend this to cubics and quartics etc.

Many sets of points are not suited to a polynomial though, so try this function:

$y = a f(x) + b g(x)$

Use
 $a\Sigma f(x).f(x) + b\Sigma f(x).g(x)$

$= \Sigma y.f(x)$

$a\Sigma f(x).g(x) + b\Sigma g(x).g(x)$
 $= \Sigma y.g(x)$

Examples of functions are:

$y=ae^x+be^{-x}$

$y=a \sin x + b \cos x$

putting $f(x)=x$ and $g(x)=1$ will give a straight line fit.

Of course you now have a problem solving the resulting simultaneous equations, but there are many programs around that will do that.
S.W.

UK okay?

I am thinking of buying a UK 101 as a hobby computer. Would you recommend this computer for a "first" and which book on BASIC would you suggest bearing in mind the use to which it would be put?

PCW Reader, Harrow, Middx.

A personal computer can start from a chip set or with a ready to run complete boxed system, plus you can buy in at almost any level in between. It's largely a choice of how many problems you pay the manufacturer to solve, and how many you take on yourself.

Buying a kit solves the vital problems of design and layout, but leaves you the assembly and test work. This size of computer has 1,000 or more soldered joints and they all have to be good. If you can't make a perfect joint almost in your sleep, practise on something much less complex first. When it's all together, double check for components the wrong way round before applying power. The checkout procedure will test each section of the machine and localise any hardware faults. In the unlikely event of an elusive fault, you will have to pay the supplier a small service charge to find and fix it for you. The buoyant state of the kit market suggests that few have trouble with kit assembly.

Complete details of the Compukit UK101 were published in *Practical Electronics*, August-November '79. Its advantage over cheaper kits includes the "industry standard" Microsoft BASIC, a powerful learning and program development tool, and compatibility with proven Ohio Scientific memory expansion and floppy disc for when you outgrow the maximum 8K on board. One of the best introductory BASIC books is *Illustrating BASIC* by Donald Alcock, but once you have learnt your way around the language, you should brush up your programming style with the *Little Book of BASIC Style* by John Nevison or *BASIC with Style* by Nagin / Ledgard.
Len Warner, Kelek Systems Ltd.



Small
Systems
Engineering
Limited

IEEE-488/PET INTERFACES

Type B £186
Bidirectional serial interface is fully addressable and can have split BAUD rates

Type C £120
Serial interface - output only
PET disk, compatible, RS232 C Handshake (Printer Busy), switch selectable Baud rates, Listen Address link selectable.

Type CS £132
Serial interface output only with switchable character sets to match the new PET's lower case Screen mode, otherwise as Type C.

All interfaces are crystal controlled

Type G.P.I. A.P. £249
Micro-based, bidirectional with buffering. The General Purpose Interface allows free use of PET's INPUT # statement without hangup problems. Software changeable BAUD rates optional features include: Second Serial I.O. Port, 20 mA Loop I.O.

Addressable parallel (disc compatible) for Centronics, Anadex etc. £106

Non addressable parallel £45

TV/Video monitor interface £35

Real Time Audio Spectrum Analyser for Commodore PET Microcomputer
32 Channels 1/3 Octave Filters, 1K ROM ROUTINES on board for analysis and graphical display. USR Functions for linkage to PET basic operating system £450

PET MEMORY EXPANSION BOARDS INTERNALLY MOUNTED

24K £328
32K £432

S100 BOARDS

Dynamic Memory Boards
IEEE-S100 Specification Timing
Transparent on Board Refresh
4Mhz Z80 Operation with no wait states.
Fully tested and Burned In
Bank Select versions available -
North Star, Cromemco and Alpha Micro
I.O. Port Bank select
Bank Size to 64K in 16K increments

Size	Standard	Bank Select
64K	£449	£595
48K	£398	£539
32K	£346	£483

P&T IEEE-488 Interface
Provides S100 computers with IEEE-488 Controller, Listener, Talker, Capability £350

All prices exclude VAT
P&P £5.00 (includes Securicor Express Delivery)

62 New Cavendish Street · London W1M 7LD
Telephone: 01-637 0777 Telex: 8813085 (Abacus)

PAYROLL

Compiled and edited by Mike Knight of Mike Rose Micros

What is the most important administrative system in your company? Ask that question of any business manager and you will get a variety of answers. Ask that question of an employee and he will almost certainly say "The Payroll"! One of my earliest recollections in the computer industry just over twenty years ago is of a very emotional wages clerk talking to the data processing manager saying: "He (sob) didn't say what was wrong (sob) with his payslip (sob) he just punched me on the nose (how)!!"

There are some business functions where mistakes can be rectified by actions taken sometimes many months later, Payroll is NOT one of these.

Objectives

The objective of payroll is to pay employees the amount due on time and to meet statutory requirements.

Most people think of payroll as an automatic choice for computerisation. However, bearing in mind my warning illustration above, I think it is one major application which MUST give benefits if it is going to be computerised. What benefits you may ask?

Well firstly payroll has specific deadlines so will it fit in with any other applications which you are either considering or have already implemented on your micro-computer? In many businesses everything has to stop for payroll so you may find that payday means no despatch notes for example.

If you do go ahead will it cost less in time, money or effort than your present system?

Will it provide you with the same information or more than you have at present and will you get this information before you get it now?

Will you be able to get rid of any equipment you use for payroll or will it save you bureau charges? Finally will the system allow for expansion?

Functional requirements

Having determined that payroll will benefit our business we can set down what we would expect from

our package.

1 We must be able to create new employee records, amend existing ones (including department transfers) and delete or mark leavers.

2 We must be able to input all variable information on hours worked at various rates together with bonus calculation information.

3 We must produce payslips and we may wish to produce a coinage analysis if cash payments are to be made.

4 We should be able to do all up to gross calculations automatically including bonus calculations.

5 We should be able to do all gross to nett calculations and must be able to calculate Tax and National Insurance.

6 We must be able to analyse both payments and deductions of varying types.

7 We must be able to cater for any variation of pay cycle, particularly weekly and monthly.

8 It should make no difference whether pay is calculated by hourly rates or if salaries are paid.

9 Finally year end requirements should be catered for automatically.

Evaluations

VLASAK PAYROLL

This system was written by Vlasak Electronics Ltd, of Marlow, Bucks (06284 74789) and is available direct from them or from any of their countrywide dealers. The minimum hardware required is a 48K Apple II, two disc drives and a 132 column printer, which costs approximately £3300. The package is written in BASIC (Applesoft) and the cost includes personalisation. If required, customisation would be undertaken and charged according to the amount of work involved. A user manual is provided which gives some systems details and a good explanation of the operation of the system. If the package is purchased together with the hardware then an installation and training service is provided. If any "bugs" were found they would be repaired free but any corruption of either the program disc or data files by misoperation would involve a charge for repair or replacement. Linkages are provided to Vlasak's Sales, Purchase, Nominal and Stock systems.

WISBECH PAYROLL

This package was written by Wisebech Computer Services Ltd., of Wisbech, Cambs (0945 64146) and is based on their successful "WISPAY" system for the IBM 370. It is available from their dealers throughout the country. There are 34 programs within the package written in BASIC and linked by a main menu and six sub-menus. The package is heavily parameterised and as such has not required either personalisation or additional customisation (as yet). It has been available since August 1979 and there are 8 users who pay a quarterly lease dependent on the number of employees. The cost per employee varies from 10p per week up to 50 employees down to 5p per week for over 250 employees. There is an installation and training charge of £50+ expenses and an annual maintenance charge of £100. The charges include an on site installation and training service, automatic updating of both statutory changes and system enhancements, automatic correction of bugs or defects found and a day to day telephone backup service. The minimum hardware required is a 32K North Star Horizon with two discs, VDU and printer and costs £3700. The documentation provided is a user manual which contains both systems and operations information and, although printed on a computer, is supplied in a presentation binder with each page in a plastic "page cover". The content is excellent and I am certain their users have no difficulty in running the system. (If any of the users are reading this article perhaps they would like to write and let us know what they think.)

INTEX PAYROLL-200

This package was written by Intex Datalog Ltd of Stockton-on-Tees, Cleveland (0642 781193) and is designed to run on a 32K PET with dual floppy discs and a printer. The package costs £50 and is supplied with an operating manual which has obviously been produced with the first time user in mind. The illustrations are of the screens the user would see on his VDU and a full explanation is given of every function. A customisation service is provided on request.

SYSTEMS

Tasks and volumes

TASKS	VLASAK	WISBECH	INTEX	MICROSOLVE	ARMSTRONG	TRIDATA
Create new employee record	*	*	*	*	*	*
Amend existing employee	*	*	*	*	*	*
Delete employee	*	*	*			
Transfer employee		*				
Pay cycle — weekly	*	*	*	*	*	*
— 2 weekly				*		*
— 3 weekly						*
— 4 weekly						*
— monthly	*	*	*	*	*	*
Pay type — hourly	*	*		*	*	*
— weekly	*	*	*	*	*	*
— monthly	*	*	*	*	*	*
Print — payslips	*	*	*	*	*	*
— payment analysis	*	*	*	*	*	*
— NI ”		*		*	*	
— Tax ”		*		*	*	
— Coinage ”	*	*	*	*	*	*
— Employee list	*	*	*			
— Bank ”		*				*
— Year end tax returns		*		*		*
— Unused employee numbers						*
Pay means — Cash	*	*	*	*	*	*
— Credit transfer		*				*
— Cheque		*				
Pensions	*	*			*	
Holiday pay		*	*	*		*
Sick pay		*	*	*		
Employee enquiry						*
VOLUMES AND COSTS						
No. of hourly rates	4	15	3	2	1	5
Payment elements	5	15		3		
Deduction elements	5	15		3		5
No. of employees	200/ disc	300/ disc	200	200/ disc	150	400/ disc
Cost of hardware	£ 3300	£ 3700		£ 2429		£ 3334
software	£	lease		£ 400	(200)	£ 218
TOTAL	£			£ 2829	£ 4000	£ 3552

MICROSOLVE PAYROLL

This package was written by Microsolve Computer Services Ltd of Edgware, Middlesex (01-951 0218) and is available directly from them. The package consists of ten programs linked by main menu options or called direct by other programs. It is written in Applesoft BASIC and personalisation of the Payslip layout is included in the cost of the package. Customisation is undertaken on request and, to date, users who have taken advantage of this service have paid approximately £100 to £150. The package was first made available in Sep/Oct 1979 and the minimum hardware configuration is a 48K Apple, two disc drives and a printer costing £2429. An on site installation and training service is provided together with a telephone backup included in the cost of the package. Bugs are corrected free of charge and, if the user inadvertently corrupted his data, advice is given to correct the problem. A detailed operating manual is supplied with the system which contains not only the operating instructions but a good overview including contents of files used.

ARMSTRONG PAYROLL

This package was written by Armstrong Computer Services of Telford,

Salop (095283 373) and is normally sold as a complete system together with the minimum hardware — 48K Apple II, Apple II disc drive, serial printer and 9" VDU, at a total cost of £4000. This price includes a tailoring service and full support, including an updating service for tax changes. The package may also be bought as standard at £200 without the tailoring service.

TRIDATA PAYROLL

This package was written by Tridata Micros Ltd of Birmingham (021-622 6085) and is available direct from them, from all Tandy stores or from Tridata dealers. The package consists of 15 programs linked via the menu

and is written in BASIC. It was first made available in November 1979 and there are 67 users. The minimum hardware is a Tandy TRS 80 with 32K, two disc drives and a printer and costs £3334. The package is supplied with a user instruction manual which gives not only full operating instructions but many helpful hints for the first time user with no computer experience. A telephone backup service is provided for installation but no training is offered currently (no installation problems have yet been encountered). A normal warranty and update service is provided at 15% of the price and there are linkages to the Tridata nominal ledger.

OTHER SYSTEMS KNOWN BUT NOT EVALUATED

Gramma-Winter London 01-636 8210
A. J. Harding Bexhill 0424-220391
Computastore Manchester 061-832 4761
Databank Loughborough 0509-217671
Microsense Hemel Hempstead 0442 41191
Commodore London 01-388 5702
Keen Computers Nottingham 0602-583254
Arden Data Processing Leicester 0533-22255
Sumlock Bondain London 01-250 0505
Graffcom Systems Ltd London 01-734 8862
ACT Microcomputer Systems 021-455 8686
Algobel Computers Ltd 021-233 2407
Katanna Management Services Ltd 0245 76127
Landsler Software 01-399 2476
Sail 01-359 2818

LOW COST FLOPPY DISK SYSTEMS FOR YOUR TRS80 FROM CUMANA

The high quality and very reliable
TEAC FD-50A 5¼ inch mini floppy drive packaged
in single disk and dual disk configurations with
integral mains power supply unit.

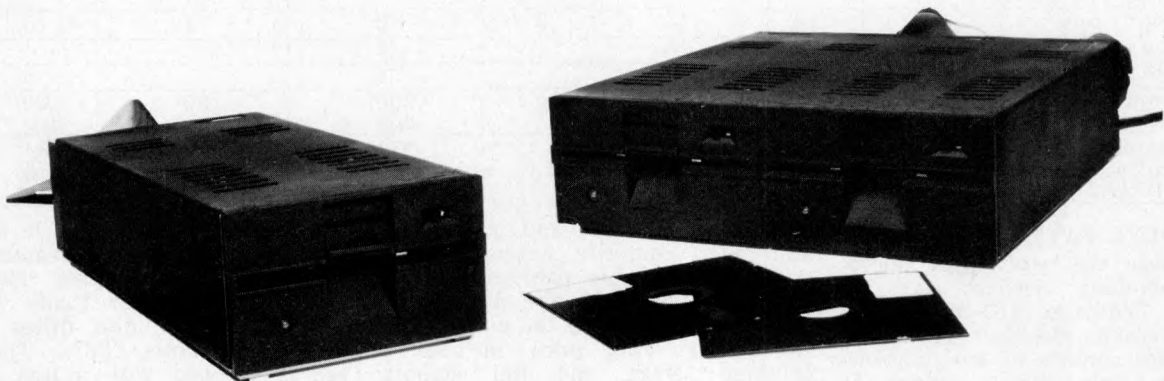

SINGLE DISK UNIT £250

DUAL DISK UNIT £440

- * Shugart SA 400 compatibility
- * Extra 5 tracks – 40 total
- * 125K bytes unformatted on 40 tracks
- * Daisy chain up to 3 FD-50A drives
- * Plugs directly onto your TRS 80 disk interface cable
- * Japanese quality and reliability
- * 220v-240v 50HZ Mains power input
- * Full warranty and service back up from Cumana

DEALER ENQUIRIES WELCOMED

Please add VAT to all prices. Delivery at cost will be invoiced separately.

Make cheques payable to

CUMANA LTD

35 Walnut Tree Close, Guildford, Surrey GU1 4UN

Tel: (0483) 503121 Telex: 859680 (INPUT G)

MACRONOIA

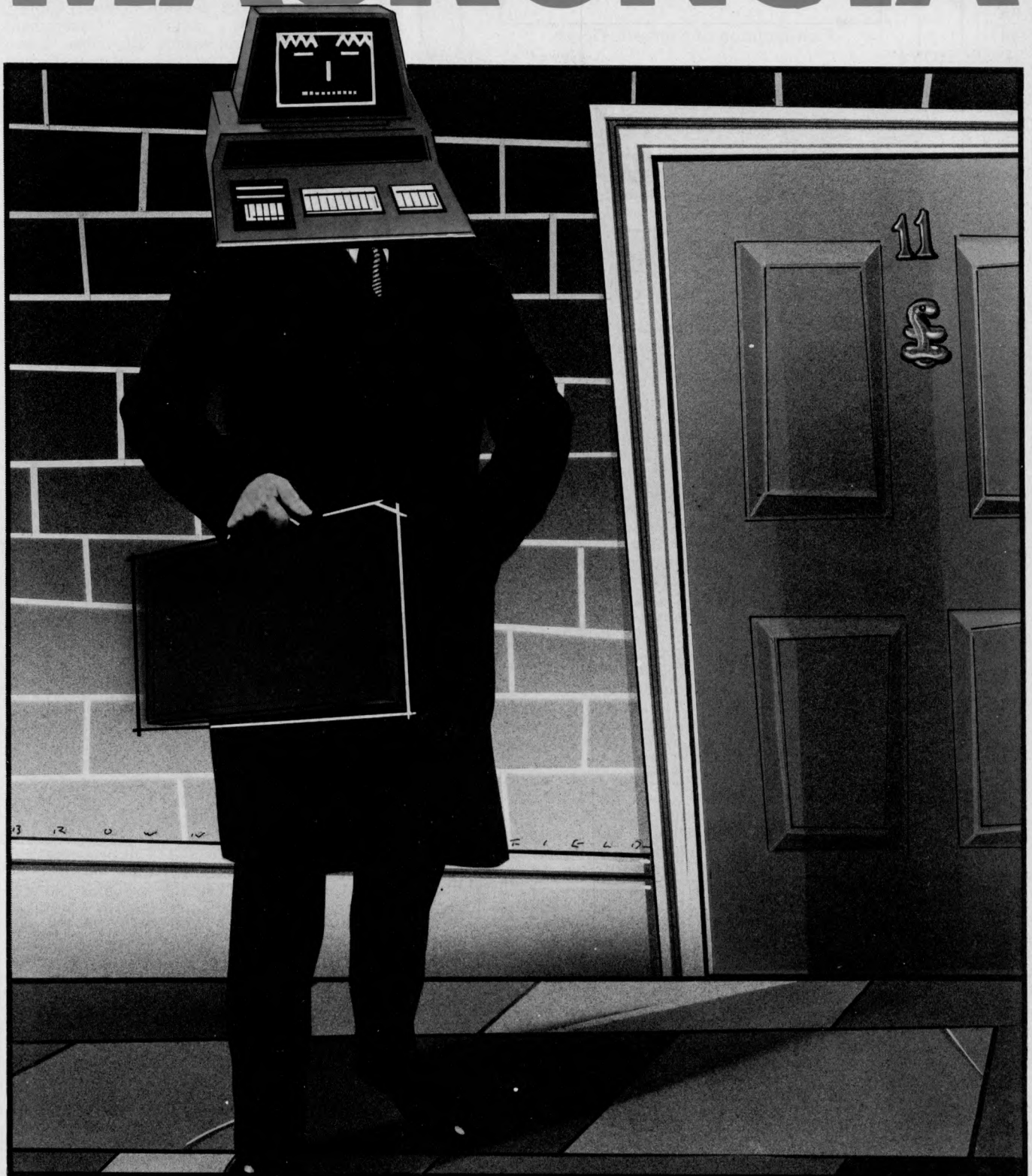

Battle with the country's economy from the relative safety of your own armchair. Can you succeed (where all others seem to be failing) at conquering the evil consequences of our bourgeois capitalist existence? Economist, Graham Addis, sets out the rules . . . the programs are in PET BASIC.

You always did think that you could do better at running the country than the Chancellor of the Exchequer (whatever his political leanings!). Well here's your chance, and the computer lets you have eight years in office to prove it! I've made the model a lot simpler than the real thing, (though it does bear some relationship to the UK economy), so

you shouldn't have any difficulty. The trouble is that no two economists can ever agree about how the economy actually works, so the program models two different theories and you can choose the one you prefer. Doubtless economists will argue with the particular set of assumptions built into the models, but then economists always

will.

THE KEYNESIAN MODEL.

John Maynard Keynes, the great economist of the 1930s who showed post-war Governments how to solve the problem of unemployment, gives his name to the first model. He taught that the economy is like a bath tub with water (money) flowing in

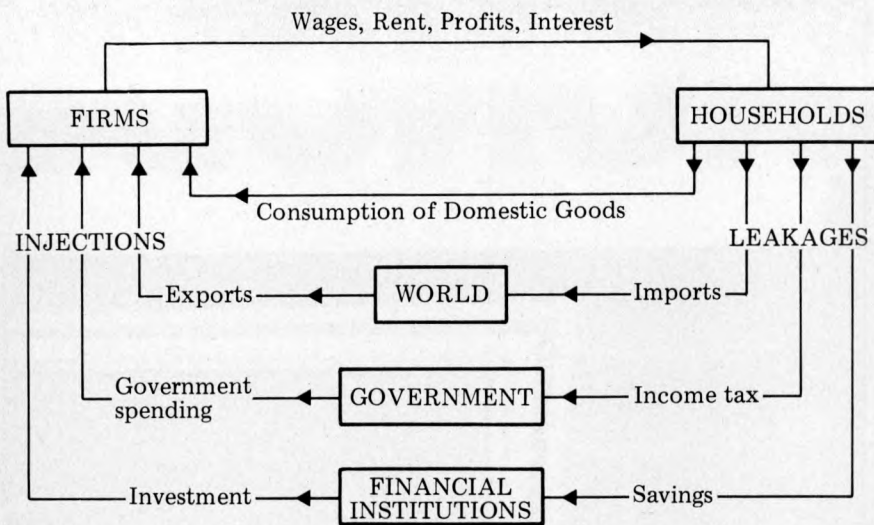

Figure 1 THE CIRCULAR FLOW OF INCOME

through the taps and leaking out through the plughole. As you will remember from your schoolday maths, if the water flows into the bath faster than it flows out, the water in the bath rises; you can control the level of the water (the level of National Income) by controlling the flow of water through the tap ("injections") and through the plughole ("leakages"). If the "water" level falls too low, you have 1930s-style unemployment, if it rises too high and slops on the floor, you have 1970s-style inflation.

The economy is of course rather more complicated than this and there are in fact several injections and several leakages, as can be seen more clearly in Figure 1, which shows the flow of Income round the economy. First break up the economy into "sectors": *firms* where goods and services are made, *households* where they are consumed, and *financial institutions* like Banks, the Stock Market, Insurance and Pension funds which channel our savings and lend our money to firms to build new factories; *the World*, to which we export and from which we import, and finally *the Government*, which controls (or at least tries to) the whole thing.

Follow the flow through with me. Firms pay out wages, salaries, dividends etc., to households which receive them as Income (the sum total paid out in one year is known as National Income). Quite a lot of that Income "leaks" out of the economy as Savings, Tax, and expenditure on Imports. Only a part of our Income is actually spent on British goods and services, and if that was the end of the story, the "bath" would soon be empty. However other sectors buy British goods and so "inject" money into the economy. Foreigners buy our exports, the Government buys hospitals and pays dustmen, and firms build new factories and buy new machinery (this is called "Investment" by economists).

The Government has control of one injection and one leakage: Government spending and taxation, and these form the main "weapons" of the Keynesian Government.

2) THE MONETARIST MODEL.

Despised by Keynes, and popularised by Milton Friedman, monetarist theories have made a remarkable come-back in the last few years, as Keynesian policies

seem to become ever less successful; indeed Margaret Thatcher is now a firm believer in Monetarism.

The theory rests on a remarkably simple equation, a tautology: $MV=PT$.

To explain it, imagine a desert island and a small community of shipwrecked sailors, with one hundred £1 notes saved from the wreck. The stock, or supply of money (M) on the island, is £100.

Suppose that each week £100 is paid out in wages, and spent, then in one year each pound will have been spent 52 times. The "Velocity of circulation" (V) is 52, and £5,200 worth of goods and services have been bought in that year.

That £5,200 could have bought 52 goods at £100, or 200 goods at £26 and so on. So we see that price (P) times the number of transactions (T) must always, by definition, equal the number of pounds spent (MV).

What happens if we change M? Clearly if M rises to 200, then either V must fall to 26, or P or T must rise, or more likely some combination of all three. Now monetarists generally assume that V is pretty well constant, and that any increase in M (money supply) must therefore lead either to an equivalent rise in the number of goods sold, or more likely in their price, and monetarists can produce statistics from the last 80 years to prove it. What makes the theory complicated is that the effects are not instantaneous, but occur after a time lag, typically of 18-24 months. Their recipe for long term success is to slow the rate of growth of the money supply to around 2-3% (the average rate at which the economy has grown in the last 20 years) arguing that this must, eventually, squeeze out inflation although at the price of some short term (how short?) unemployment.

THE AIMS OF GOVERNMENT AND HOW TO ACHIEVE THEM.

So the Keynesians believe that the economy can be controlled by altering levels of Government spending and rates of Tax, while the Monetarists believe that controlling the growth of the money supply is the only effective way to manage the country. Both however agree on what they are trying to achieve. Both want (don't we all) to bring inflation and unemployment down to some low figure (around 3% for each perhaps) while increasing the

rate at which the economy, and so our standard of living, can grow (all the while ensuring that the Balance of Payments stays firmly in the black). And that is not easy, as you will soon discover.

To control inflation, you reduce the level of total demand in the economy, either by reducing Government spending and raising Tax rates, if you are a Keynesian, or by reducing the rate of growth of the money supply, if you are a Monetarist. Keynesians believe that inflation is made worse by excessive wage settlements and so introduce incomes policies; Monetarists know that higher wages can only be paid by printing more money and say that therefore an incomes policy is irrelevant.

To reduce unemployment you reverse your anti-inflation policies.

To increase the rate of economic growth you need higher Investment (more new factories), and this is determined partly by the rate of interest (and as we are only too painfully aware, cutting back money supply growth makes borrowing money very expensive), and partly by the level of Government spending (money that the Government borrows from us to pay for its own expenditure cannot be borrowed by Industry). You may also find that Investment is temporarily reduced one year if there is a shortage of essential raw materials or labour, and boosted the next as the shortfall is made good.

To correct a Balance of Payments deficit, you can deflate, devalue, or impose import restrictions. Deflation means reducing the level of National Income so that we have less money to spend, and so less to spend on imports. Devaluation means lowering the exchange rate of Sterling, to make our exports cheaper and our imports less competitive, but at the price of higher inflation. Import quotas reduce the level of imports and some argue that they are the only means by which we can lower unemployment without running up massive Balance of Payments deficits.

It all sounds pretty complicated, but you will understand it all better as you play the game. The interrelationships in the model are fairly complex and you may be surprised at some of the things that happen, but if you don't like the look of one set of policies you can easily go back and try that year over again with different policies. There are in fact no implementation lags in executing Government policy decisions and it is deemed that all policy changes take effect as from January 1st in the current year. Why not run through eight years twice with the same policies, once with the Keynesian model, and once with the Monetarist model and compare the results?

Maybe at the end of it you will understand some of Sir Geoffrey Howe's problems better than you did before. If you do really well, why not let Sir Geoffrey know? He might recommend you as the next Chancellor!

RUNNING THE PROGRAM.

As it stands, the program needs less than 8K Bytes of store, and should run happily on most machines with a reasonable BASIC interpreter or compiler. Although written for a PET, machine dependent commands have been avoided wherever possible. To

reduce the size of the program, cut out all the REM statements and shorten or remove the comments. If you are really short of space, consider removing one or other of the main models.

The program has been deliberately written in modular form so that amending parts of the model should be relatively simple if you should want to

build in different assumptions, or extend the program.

POLICY WEAPONS.

Five policy weapons are available to you:
 1 The Level of Government Spending (in £ million at constant 1980 prices). You cannot change the level by more than 10% in any one year because it

takes time to plan cuts and put them into effect, and even more time before planned new roads etc. can be constructed.

2 The rate of Income Tax as a %. A realistic rate is between 20% and 60%. For simplicity it was decided to leave out VAT.

3 The rate of growth of the Money Supply. Again for simplicity, the model assumes that you can achieve your target rate of growth. In practice this is very unlikely to be true, because the money supply is affected not only by the level of Government spending and taxation, but also by the Balance of Payments, and the activities of the High Street banks.

4 Import Quotas (as a % reduction). You can impose quotas on all imports up to a maximum of 50%, which will reduce the level of imports below what it would otherwise have been. Other countries do not retaliate.

5 Incomes policy. You may, if you wish to, set a "norm" for wage increases, which you ask the Trade Unions to accept. You will not find them all that cooperative!

You may run the economy for eight years. During that period you should aim to keep inflation in single figures, unemployment below a million, growth of the economy of better than the historical figure of 2½% and a Balance of Payments deficit of no more than £500 million in any year.

At the end of each year you will be offered the option of rerunning that year with different policies, and at the end of your term in Office you will be offered a second term of Office, starting back in 1980 again. Have fun!

THE ASSUMPTIONS IMPLICIT IN THE EQUATIONS

The form of the equations is mostly conventional to Economics, although the parameters were chosen to make the model relatively stable, rather than to make it conform closely to reality. Even so the model may become unstable if Government policy is subject to violent changes.

The capacity of the economy is determined by the Investment/Income ratio, the rate of growth rising by 1% for every 5% increase in that ratio. Historically it has been growing at

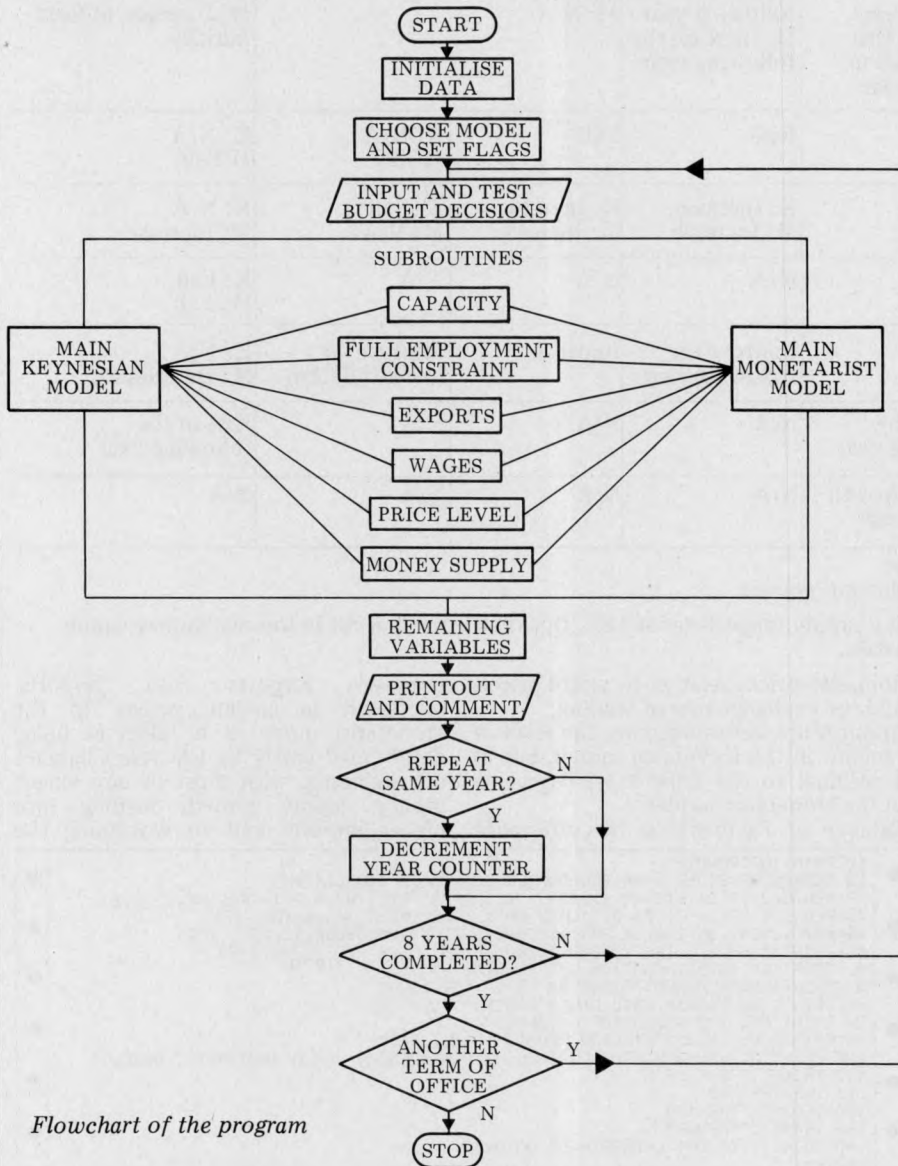

Flowchart of the program

The EQUATIONS USED IN THE MODEL

$$Q(t) = (I(t-1)/Y(t-1))^2 \times Q(t-1) \times 1.45$$

$$I(t) = 1.03 \times I(t-1) \times R(t-1)^{-1} \times 1.23$$

$$X(t) = 17324 \times 1.02^t \times (E(t)/2 \times P1(t-1)/(2.71 \times 1.05^t))^{-1.5}$$

$$K: P1(t) = (((U(t)/.26 - 2)^{-1.4} \times 9 + 2)/100 + 1) \times P1(t-1) \times W2(t-1)^2 \times (1.05^t \times 2/E(t))^{-3} / 2.58$$

$$M: P1(t) = C(t-1)^{-3} \times .83 \times .5 \times M(t)/q(t) \times .3 \times M(t-1)/Q(t-1) \times .2 \times M(t-2)/Q(t-2)$$

$$K: Y(t) = (I(t) + G(t) + D(t-1) + X(t) - 6156 + 7740.9 - 1460)/K9 \text{ where } K9 = (.1 \times (1 - T(t)) + T(t) + .35 + .35 \times (1 - A(t)))$$

$$M: Y(t) = 10 \times (X(t) + G(t) + I(t))^{-2.5} \times (M(t)/P1(t))^{-2} \times (M(t-1)/P1(t-1))^{.33} \times 2.02 \times C(t) = Y(t)/Q(t) / 1.08 \times 100$$

$$K: U(t) = ((Y(t)/Q(t)/.96)^{-2.5} + 2) \times .26$$

$$U(t) = (1 - (Y(t)/Q(t)/.96)^{1.42}) \times 260$$

$$M: U(t) = U(t) + (W2(t) \times 460/W(t))^{1.0} \times .26$$

$$K: F(t) = (Y(t) \times .35 + D(t-1) + 7740) \times (1 - A(t))$$

$$M: F(t) = X(t) - B(t)/P1(t)$$

$$B1(t) = .6 + .8 \times B1(t-1) - .16 \times (M(t)/M(t-1))/Y(t)/P1(t)/100$$

$$K: B(t) = X(t) \times P1(t) - F(t) \times 2.85 \times 1.05^t \times (2/E(t))$$

$$M: B(t) = Y(t) \times P1(t) \times B1(t)/100$$

$$W2(t) = 1360/52 \times 1.03^t \times P1(t-1)$$

$$W(t) = .08 \times M(t)^8 \times M(t-1)^{-2} \times C(t-1)^{-5}$$

$$R(t) = Y(t) \times P1(t) / .9 / \text{ABS}(M(t) + 0(t))^2 + 2$$

$$O(t) = T(t) \times Y(t) - 1460 - G(t)$$

POLICY MATRIX – summarising the effects of policy changes, all other things remaining constant.

Policy change	Increase in Government spending	Increase in rate of Income tax	Fall in rate of Exchange	Imposition of Import quota	Incomes Policy	*Increase in real Money Supply (M/P1)
Effect on: National Income	K: Increase M: Increase	K: Fall M: No direct effect in first year – fall in second year	K: Increase the following year M: Increase the following year	K: Increase M: N/A	N/A	K: N/A M: Increase, at least initially
Unemployment	Fall	Rise	Rise	Fall	K: N/A M: Fall	K: N/A M: Fall
Inflation	K: Increase M: Increase	K: Fall M: Fall	K: Increase M: Increase	K: Increase M: Increase	K: Fall M: N/A	K: N/A M: Increase
Rate of Interest	Increase	Fall	N/A	N/A	N/A	K: Fall M: Fall
Balance of Payments	Deteriorate	Improve	Improve the following year	Improve	Improve via lower inflation	K: N/A M: Deteriorate
Investment	Fall in the following year	Rise in the following year	N/A	N/A	N/A	Rise in the following year
Capacity	Rate of growth will fall	Rate of growth will increase	N/A	N/A	N/A	N/A

K: Keynesian Model – M: Monetarist Model
N/A – Not applicable or the effects are small and indirect.

*If inflation is running at 18% and the money supply target is set at 12%, this is effectively a *cut* in the real money supply, and should be interpreted as such on this matrix.

around 2.5% p.a.
Investment grows at 3% p.a. but the rate of growth is reduced by 0.1% for every 1% increase in the rate of interest.
The Price Level is a complicated function, expressed as an Index, a percentage of some base year. In the Keynesian model it is a non-linear equation determined by the level of unemployment, the level of average wages, and the price of imports (itself affected by world prices growing at 5% p.a., and the exchange rate of Sterling). Every 1% rise in wages, raises the Price Index by .2%, every 1% increase in import prices raises it by .3%.

In the Monetarist model the Price level is determined by the level of capacity utilisation, and the ratio of the money supply to capacity, lagged over three years. For every 1% of excess money supply growth over capacity growth, the Price Index grows eventually by 1%.

Income in the Keynesian model is determined by the level of injections and the rates of the various leakages. In the Monetarist model National Income is determined partly by the level of injections, and partly by the level of money supply (adjusted for inflation). Clearly an increase in the money supply will initially increase Income, through the unlagged term, but the effect on the price level will tend to depress Income in the following year.

Unemployment – two non-linear equations are used, but essentially unemployment is determined by the ratio of Income to Capacity. In the Monetarist model unemployment is increased if wage rates increase faster than the money available to pay those wages.

Exports are determined partly by the growth in world trade (2% p.a.), and partly by their dollar price, which is affected both by our own level of

domestic prices relative to world prices, and the exchange rate of sterling.

Imports are determined by the level of Income in the Keynesian model, but as a residual to the Balance of Payments in the Monetarist model.

Balance of Payments is the difference

between Exports and Imports, expressed in current prices. In the Monetarist model it is taken as being determined partly by last year's balance of payments, with most of any excess money supply growth feeding into higher imports and so worsening the

```

10 PRINT"MACRONOIA"
20 REM***COPYRIGHT 1980:BROADWATER ECONOMICS SIMULATIONS
70 READG(2),T(2),E(2),A(2),M3(2),I(2),Y(2),Y(1),Q(2),Q(1),R(2),P(2),U(2)
75 READZ(2),B(2),P1(2),D(2),M(2),M(1),C(2),M2(2),K3,B1(2),K6,K7
80 DATA12500.,35,2.0.,1.9241,50289,49272,54100,53000,12,16,1.102
85 DATA2.8,-871,3.14,0.55000,50000,86,78,17324,-.57,7740,1460
91 PRINT"IN 1979 INFLATION WAS RUNNING AT 16%"
92 PRINT"UNEMPLOYMENT STOOD AT";U(2);"MILLION"
93 PRINT"THE GROWTH RATE WAS A PALTRY";Z(2);"%
94 PRINT"AND THE BALANCE OF PAYMENTS"
95 PRINT"WAS";B(2);"MILLION POUNDS IN THE RED"
100 PRINT"DO YOU WANT TO RUN THIS AS A KEYNESIAN OR A MONETARIST MODEL?"
112 PRINT"TYPE K OR M";
115 INPUTA$:K=0
120 IFA#="K"THEN150
130 IFA#="M"THEN200
140 PRINT"I DO NOT UNDERSTAND":GOTO100
150 K=1
200 FORJ=3TO10:PRINT"ENTER BUDGET DECISIONS FOR THE YEAR";1977+J:PRINT
210 PRINT"LEVEL OF GOVERNMENT EXPENDITURE"
211 PRINT"LAST YEAR WAS";G(J-1);": INPUTG(J)
220 IFABS(G(J)-G(J-1))<.1*G(J-1)THEN240
230 PRINT"CHANGE IN GOVERNMENT EXPENDITURE EXCEEDS"
231 PRINT"PRACTICAL LIMITS":GOTO210
240 PRINT"AVERAGE RATE OF DIRECT TAX % LAST YEAR"
241 PRINT"WAS";T(J-1)*100;": INPUTT(J)
250 T(J)=T(J)/100:IF(T(J)-.2)*(.6-T(J))>0THEN270
260 PRINT"TAX RATE IS OUTSIDE POLITICALLY"
261 PRINT"ACCEPTABLE LIMITS":GOTO240
270 PRINT"EXCHANGE RATE OF STERLING LAST YEAR"
271 PRINT"WAS";E(J-1);": INPUTE(J)
280 IF(E(J)-1)*(.3-E(J))>0THEN300
290 PRINT"EXCHANGE RATE IS OUTSIDE POLITICALLY"
291 PRINT"ACCEPTABLE LIMITS":GOTO270
300 PRINT"IMPORT QUOTA-% REDUCTION IN IMPORTS LAST YEAR WAS";A(J-1)*100;":
301 INPUTA(J):A(J)=A(J)/100
310 IFA(J)<.5THEN320
315 PRINT"QUOTA IS UNACCEPTABLY HIGH":GOTO300
320 PRINT"DO YOU WANT AN INCOMES POLICY?(TYPE Y OR N)":INPUTA#
330 IFA#="N"THEN390
340 IFA#<"Y"THEN360
341 K2=K2+1:IFK2<3THEN370
350 PRINT"UNIONS WILL NOT TOLERATE A FURTHER";
351 PRINT"YEAR OF WAGE RESTRAINT":GOTO390
360 PRINT"I DO NOT UNDERSTAND":GOTO320
370 PRINT"GOVERNMENT NORM FOR PAY INCREASES"
371 INPUTK1
375 IFK1=0THEN400
380 PRINT"UNIONS INSIST THAT PAY NORM BE POSITIVE ":GOTO370
390 K2=0
400 PRINT"MONEY SUPPLY GROWTH TARGET-ENTER % LAST YEAR ";
405 PRINT"WAS";M3(J-1)*100;":
406 INPUTM3(J):M3(J)=M3(J)/100:IF(.5-M3(N))>0THEN430
    
```



```

● 420 PRINT"GROWTH TARGET UNREALISTIC":GOTO440
430 IF K=0THEN800
440 REM***KEYNESIAN MODEL*****
● 454 GOSUB1000
460 GOSUB1100
465 K9=(.1*(1-T(J))+T(J)+.35*(1-A(J)))
470 Y(J)=(I(J)-6156+G(J)+X(J)+D(J-1)+K6*.9-K7)/K9:K8=Y(J)
480 GOSUB1050
483 GOSUB1200
485 GOSUB1300
490 IFQ(J)>=(Y(J)/.95)THENGOTO510
500 Y(J)=Q(J)*.95
510 F(J)=(Y(J)*.35+D(J-1)+K7)*(1-A(J)):C1(J)=(Y(J)*(1-T(J))+K6)*.9-6156
530 B(J)=X(J)*P1(J)-F(J)*2.85*1.05↑J*2/E(J)
550 GOSUB1500
560 GOTO900
795 REM***MONETARIST MODEL*****
800 GOSUB1500
810 GOSUB1000
820 K4=.5*(M(J)/Q(J)+.3*(M(J-1)/Q(J-1)+.2*(M(J-2)/Q(J-2)))
830 GOSUB1300
840 GOSUB1100
850 Y(J)=10*(X(J)+G(J)+I(J))+.25*(M(J)/P1(J))+.2*(M(J-1)/P1(J-1))+.33*2.02
860 C(J)=Y(J)/Q(J)*100/1.08
865 IFQ(J)>=(Y(J)/.95)THEN868
866 Y(J)=Q(J)*.95
868 GOSUB1200
870 GOSUB1050
871 U(J)=U(J)+W2(J)*460/W(J)+10*.26
875 B1(J)=.6+.8*B1(J-1)-.16*(M(J)-M(J-1))/Y(J)/P1(J)*100
880 B(J)=Y(J)*P1(J)*B1(J)/100
890 F(J)=X(J)-B(J)/P1(J)
895 B(J)=B(J)+A(J)*F(J):F(J)=F(J)*(1-A(J))
900 R(J)=(Y(J)*P1(J)/.9/(ABS(M(J)+O(J))))↑2+2
905 D(J)=(K8-Y(J))*K9/2:K5=I(J)-D(J)
910 O(J)=(T(J)*Y(J)-G(J)-K6)*P1(J)
920 Z(J)=(Y(J)/Y(J-1)-1)*100
930 GOSUB1600
935 PRINT"IF YOU WANT TO RERUN YEAR";1977+J;"PRESS Y -";
940 PRINT"TO CONTINUE WITH YEAR";1978+J;"PRESS ANY KEY";
950 INPUTA#:IFA#<"Y"THEN980
960 J=J-1
980 NEXTJ
990 GOSUB1800
991 STOP
995 REM***CAPACITY*****
1000 Q(J)=(I(J-1)/Y(J-1))+.2*1.45*(O(J-1)-I(J)=1.03*I(J-1)*R(J-1)+(-.1)*1.23
1010 RETURN
1049 REM***FULL EMPLOYMENT BARRIER*****
1050 IFY(J)<.85*(O(J)THEN1070
1060 U(J)=(Y(J)/Q(J)/.96)+(-25)+2)*.26:GOTO1080
1070 U(J)=(1-(Y(J)/Q(J)/.96)+1.42)*260
1080 RETURN
1095 REM***EXPORTS*****
1100 X(J)=K3*1.02↑J*((E(J-1)/2)*(P1(J-1)/2.71/1.05↑J))+(-1.5)
1110 RETURN
1195 REM***WAGES*****
1200 IFK2=0THEN1250
1220 IFK2=2THEN1240
1230 W2(J)=W2(J-1)*((100+K1*1.2)/100):GOTO1255
1240 W2(J)=W2(J-1)*((100+K1*1.5)/100):GOTO1255
1250 W2(J)=(1360/52)*1.03↑J*P1(J-1)
1255 IFK=0THEN1270
1260 RETURN
1270 W(J)=.08*(M(J)+.8*(M(J-1))+.2*(M(J-2))+10.5*W1(J)=W2(J)/P1(J)*52
1280 RETURN
1295 REM***PRICE LEVEL*****
1300 IFK=0THEN1340
1320 P1(J)=((U(J)/.26-2)+(-1.4)*9+2)/100+1)*P1(J-1)*W2(J-1)+1.2
1321 P1(J)=P1(J-1)*((1.05↑J*2/E(J))+.3/2.58):GOTO1350
1340 P1(J)=K4*(J-1)+1.3*.83
1350 P(J)=(P1(J)/P1(J-1)-1)*100
1360 RETURN
1495 REM***MONEY SUPPLY*****
1500 M(J)=M(J-1)*(1+M3(J))
1510 RETURN
1595 REM***PRINTOUT*****
1600 PRINT"","YEAR";1977+J
1610 PRINT"INFLATION",INT(P(J)*10)/10;"%", "GROWTH",INT(Z(J)*10)/10;"%"
1620 PRINT"UNEMPLOYMENT",INT(U(J)*1000)/1000;"MILLION"
1630 PRINT"BALANCE OF PAYMENTS",INT(B(J));"MILLION POUNDS"
1642 PRINT"PRESS ANY KEY TO CONTINUE"
1643 INPUTA#:IFA#<"Y"THEN1645
1645 PRINT"","","CONSTANT PRICES"
1650 PRINT"NATIONAL INCOME $M", "", INT(Y(J))
1660 PRINT"INVESTMENT $M", "", INT(K5)
1665 PRINT"FALL IN STOCKS $M", "", INT(D(J))
1670 PRINT"RATE OF INTEREST %", "", INT(R(J)*10)/10
1680 PRINT"PRICE INDEX 1963=100",INT(P1(J)*100)/100
1690 PRINT"EXPORTS $M", "", INT(X(J))
1700 PRINT"IMPORTS $M", "", INT(F(J))
1705 PRINT"","","CURRENT PRICES"
1710 PRINT"MONEY SUPPLY $M", "", INT(M(J))
1720 PRINT"BUDGET $M", "", INT(O(J))
1730 PRINT"AVERAGE WEEKLY WAGE $",INT(W2(J)*100)/100
1740 IFU(J)<1THEN1750
1745 PRINT"UNIONS ARE UNHAPPY ABOUT THE LEVEL OF"
1746 PRINT"UNEMPLOYMENT*****";
1750 IFQ(J)<10THEN1760
1755 PRINT"VOTERS ARE WORRIED ABOUT THE RATE OF"
1756 PRINT"INFLATION*****";
1760 IFB(J)>(-1000)THEN1770
1765 PRINT"BALANCE OF PAYMENTS DEFICIT IS"
1766 PRINT"UNACCEPTABLY HIGH*****";
1770 IF2(J)>2THEN1780
1775 PRINT"AT THIS RATE OF GROWTH YOUR COUNTRY"
1776 PRINT"WILL SOON BE THE POOREST IN EUROPE!*****"
1780 RETURN
1800 PRINT"YOUR TERM OF OFFICE IS NOW COMPLETE"
1810 N1=0:N2=0:N3=0:N4=0
1890 PRINT"WANT TO TRY YOUR HAND AGAIN?"
1895 PRINT"TYPE Y OR N";
1900 IFA#="Y" THEN10
1910 RETURN

```

balance of payments position. Average weekly wages normally keep pace with the previous years inflation (Trade Unions are always trying to make good this years fall in living standards), with a target of a 3% p.a. improvement in living standards. Government Incomes policy will reduce the rise in money wages, but when the incomes policy comes off, Unions will attempt to catch up all the ground lost. The total wage bill. In the monetarist model the total amount of money paid out in wages is determined partly by the money supply over two years) and partly by the level of unemployment — Trade Unions can generally get bigger wage settlements when there is Full Employment. The Rate of Interest is deemed to be a function of the ratio of National Income in current prices to the Money supply (adjusted for the Budget deficit). If the money supply grows more slowly than the rate of inflation and the level of Income, then interest rates will rise. The larger the Budget deficit the higher will interest rates have to rise in order to persuade people to lend money to the Government. The Budget Deficit is simply the difference between total tax revenue and Government spending, expressed in current prices.

LIST OF THE VARIABLES USED

Arrays

A(J) % Quota in Imports
B(J) @ Balance of Payments
B1(J) Intermediate B of P variable
C(J) % Capacity Utilisation
C1(J) * Consumption expenditure
D(J) *Unplanned reduction in stocks
E(J) Exchange rate of Sterling against the Dollar.
F(J) *Imports
G(J) *Government Expenditure
I(J) *Planned Investment
M(J) @ Money Supply
M3(J) % Money supply growth target
O(J) @ Budget surplus/deficit
P(J) % Inflation rate
P1(J) Price Index
Q(J) *Capacity of the economy
R(J) % Rate of Interest
T(J) % Average Income tax rate
U(J) Millions unemployed
W(J) @ Total wage bill
W2(J) @ Average weekly wage
X(J) * Exports
Y(J) *National Income
Z(J) % growth rate of Income

*1970 constant prices
@ Current prices.

Simple variables.

J Time Subscript
K Model flag
K1 Government Pay norm
K2 Incomes policy counter
K3 Base export value
K4 Intermediate price variable
K5 Actual Investment
K6 Tax intercept value
K7 Import intercept value
K8 Planned Income
K9 Intermediate Income variable

INTERRUPT

has a long history — one has but to recall “the world the steam engine made”, the era of the motor car, the atomic age . . . Nearly all commentary on microelectronics has been conducted within this frame: the silicon chip was “discovered”; it was found to have “incredible” powers; it developed at “breathtaking” pace; it will continue to so develop and the technology will change us all. The social implications are as follows . . . blah, blah, blah.

The problem is not so much that the predictions are frequently miles off target or that they are so easy to make and often so absurd that they can scarcely be taken seriously. More important, the very procedure which underlines futurism is itself wrong. To talk in a way which assumes that technology is here today and hence social implications follow tomorrow is a facile caricature of the complexity of social organisation and social change. Not only is the linear equation, technology = new products = social implications miles off the mark, perhaps even more misleading is that this approach separates technology out from society at the start of its futurology, only to reintroduce it later as a cause of social change.

Technology cannot be separated out from society in this way. An adequate analysis must start from the principle that technology is *always* integrally tied to society and to really understand its growth, its ties with social contexts

have to be seen. Thus a sociologist would try to grasp the rapid growth of the micro by locating the technology in the social context of the cold war, the arms race, the battle for space, a growing demand for improvements in communications in an increasingly international world, the expansion of key multinational corporations, massive injections of investment by American governments, the R and D budgets of giant companies like IBM, etc etc.

Here the sociologist would be resisting the current assumption that technology arrives from out of the blue to deliver a number of consequent social effects. Reconstructing the history of the chip would demystify today's technological “revolution” by pointing out the “social origins” of the micro. Its “discovery” by the British public becomes comprehensible in the light of the special circumstances of its growth.

At present, the science fiction selling of the micro makes it almost impossible for mere mortals to query its uses — simply because it seems so “scientific”, “unworldly” and “miraculous”. Showing that the growth of technology is explicable in terms of social processes allows the public of today an opportunity to genuinely debate the role of recent developments. Only at that point can they start to question what technology this and future societies should and could have.

In order to get away from science

fiction and into the realms of reality, as the excellent Malcolm Peltu has been stressing for some time, we have to stop talking about this abstraction, the “microelectronics revolution” and start discussing the particular products.

One aspect of the mass scale development of microelectronic devices in the domestic sphere is the enhanced television — certainly a product that's been produced to respond to (and of course in turn influence) social situations. The following illustration will I hope show the way in which the social context and technology are integrally related.

Coming through the TV pipeline are remote control, teletext, viewdata, video games, home computers, etc. The reason that these devices are being produced is that 97% of British homes already have television and the new products are designed to build upon this basis. But there is more to this than merely noting that high ownership (and/or rental) of TV is a prerequisite for the introduction of new technologies. Another social factor of importance is that building on television's penetration is necessary, not least because of the negative, even intimidating image many people have of computers. Thus if corporations can produce goods which appear to merely extend TV while they in fact incorporate computing facilities, then more sales will result. The most *continued on p87*

POWERFUL MICROS AT THE RIGHT PRICE

- Multi-User ● Multi-Tasking
- Multi-Language ● Hard Disc Storage ● Word Processing
- Priced from under £5000

Languages supported include — Basic, Cobol, Fortran.
OEM, Educational and Dealer enquiries invited

EQUINOX
COMPUTER SYSTEMS LIMITED
Kleeman House, 16 Anning Street
New Inn Yard, London EC2A 3HB
Tel: 01-739 2387 & 01-729 4460

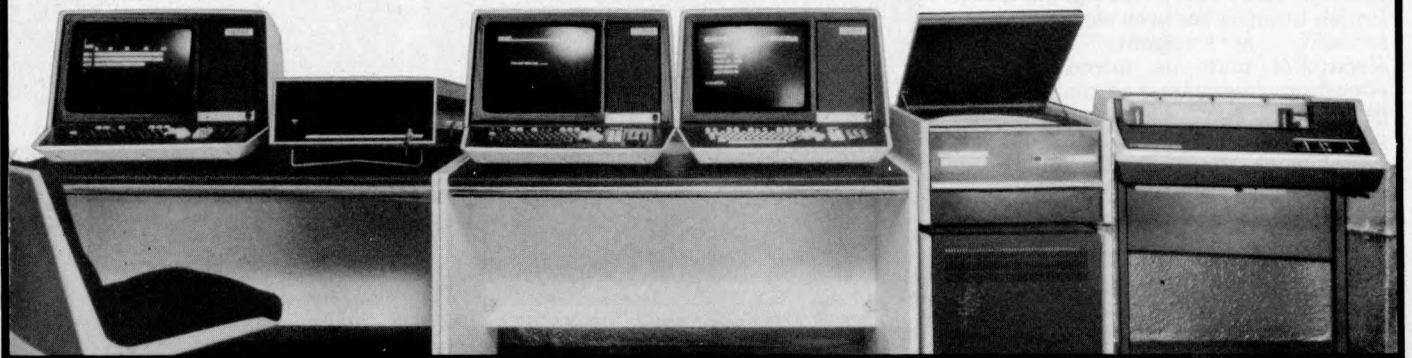

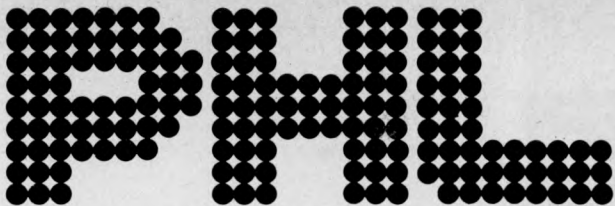

...when you need a dependable supplier, an authorised distributor with a comprehensive range of products at keen prices, backed by large stocks for fast delivery, with full after-sales support. We promise you a rapid response.

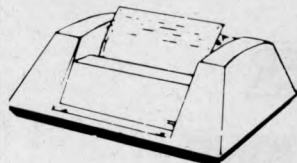

ANADEX DP8000

Exceptional value and high reliability. 84 lines per minute, 112 cps. Parallel and serial interfaces as standard. 96 ASCII set, 9 x 7 font. Variable tractor. Forms handling facilities. 1K buffer store. Options include 2K extra store IEEE interface.

from only **£540**



LEAR SIEGLER ADM-3A

The most popular visual display in the world. 1920 character screen capacity. Cursor addressing. Dual interface. Auxillary port. Wide range of speed and word formats. Options include Tektronix 4010 compatible graphics.

from only **£570**



LEAR SIEGLER ADM-31

Low cost VDU with two page display and full editing features. Dual interface, 50-9600 baud data rates. Upper/lower case character set. Cursor addressing, editing, protected fields, dual intensity. Optional polling and addressing, printer port.

from only **£795**



TELETYPE 43

Versatile, economic and reliable. 30 cps, serial interface keyboard printer. 132 or 80 columns. 94 ASCII set, 9 x 7 font. Crisp, high quality printout. Microprocessor controlled. Portable versions. Character set options.

from only **£799**



TYPEWRITER TERMINAL

Two machines for the price of one. Typewriter style friction feed for single documents, letters etc. Pin feed for continuous business stationery. Electric typewriter keyboard layout and touch. Left and right hand margin setting. Crisp, high quality printout.

from only **£825**

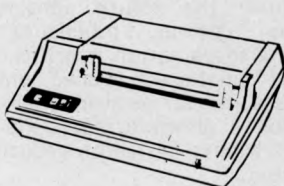

TEXAS 810

Compact 150 cps 132 column printer. Optimised bi-directional printing. Adjustable tractor feeds, 3 - 15 inches. 9 x 7 dot matrix. RS232 interface. Forms control options. Other serial and parallel interface options. Compressed print option.

from only **£1392**

LOW COST GRAPHICS TERMINAL

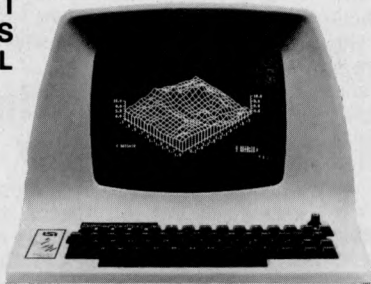

£1295

A low cost Tektronix 4010 compatible option means that we can offer the well-known Lear Siegler ADM 3A with powerful graphics capability. A Z-80A microprocessor and RAM sufficient to provide a 512 x 250 dot grid and automatic scaling from a 1024 x 780 dot grid enable point plotting, vector drawing and alphanumeric character display.

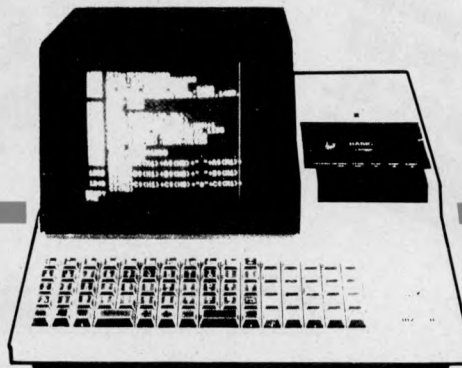

SHARP MZ80K

THE FIRST
DESKTOP
COMPUTER
TO STRIKE
THE **STOP PRESS**
RIGHT CHORD!

SEE ALL OUR
COMPUTERS AT
OUR GREAT SPRING EXHIBITION
OPENS APRIL 22nd 1980

AT LAST!

THE MICROPROCESSOR
THAT BRINGS
SOUND TO YOUR
PROGRAMME.
COME AND
LISTEN TO THE
DIFFERENCE AT
THE COMPUTERIST
SOUTH EAST ESSEX
FIRST COMPUTER
SHOWROOM AND
BOOKSHOP
642 London Road
Westcliff-on-Sea, Essex
Telephone Southend 335298
and
Dair Electronics
Your North Essex
Computer Centre
33 High Street
Halstead, Essex.
Telephone 2533



THE COMPUTERIST
DAIR
ELECTRONICS

PERIPHERAL HARDWARE LIMITED

Armfield Close West Molesey Surrey Telex 922175

SOUTH
01-941 4806

NORTH
Harrogate 501263/4

IRELAND
Dublin 952316

THE COMPLETE PASCAL

BY SUE EISENBACH AND CHRIS SADLER

CHAPTER 7 PROCEDURES AND FUNCTIONS

Throughout this series we have used procedures to break programming problems into collections of interlinked but self-contained modules. This chapter seeks to examine the different means of interlinking such modules and thereby to analyse the different roles which they play in modular program design.

Introduction

If something has to be done several times within a program, perhaps under different conditions or within different contexts, it can either be coded over and over again, whenever it is required or it can be coded once only and initiated from those points in the rest of the program where it is needed. In consequence, even the most elementary assembly languages usually provide some method of dividing a program into modules (or *subroutines*) and of interrupting the normal linear program flow by a subroutine call to some piece of code remote from that section currently being executed. However, it is one thing for a programmer to use such a facility as a convenience, when the occasion arises, and entirely another deliberately to design a program as a hierarchy of interdependent subroutines each with a specific if limited role within the whole program task.

The advantages of this approach to program writing emerge from a consideration of the process of producing and running a program in general. Firstly the task is hierarchically divided and subdivided into successively more detailed modules each of which has a well-defined, yet limited goal. If the goal is well-defined, the subroutine will be easy to code correctly. If the goal is limited, the subroutine will be more likely to produce the correct results and in addition makes the logical structure of the whole program simpler. Secondly, execution errors will pinpoint the subroutines within which they occur so that debugging a program fragmented in this manner is reduced to debugging one or two offending subroutines. Thirdly, features of the program which depend on special machine, peripheral or operating system characteristics are likely to be concentrated into a few subroutines which can be adapted to another computer environment without disturbing the rest of the program. Likewise, when transferring to a machine with limited memory, *overlaying* (i.e. the splitting of a program so that only a portion is resident in memory at any given time) is greatly assisted if the program is modular.

Finally, designing programs in this way imposes a discipline on the pro-

grammer which reflects itself in a logical and consistent approach to programming problems. This means that programs are easier to read and understand by other people. In *block-structured languages* which are designed to exploit this philosophy (and of which PASCAL is a member) the program consists of a number of procedures, within which may be *nested* other procedures, all controlled from the main program block. Variables declared within a procedure are local to the procedure and have no value outside the scope of that procedure.

Several important points arise from a consideration of the technical mechanisms necessary to achieve a satisfactory transfer of control from procedure to procedure. It is fairly simple to call a procedure — the procedure name is associated with the address of the first statement of the procedure so that, when the procedure is called, this address can be loaded into the program counter and processing can continue. However, getting back to the calling point when the procedure has finished is more difficult since the actual execution of the procedure will have altered the “state” of the processor.

For instance, the address of the statement immediately *following* that which initiated the procedure has to be loaded into the program counter for processing to continue after the called procedure has finished. However, the procedure could have been called from anywhere within the program and cannot “know” in advance what point control is supposed to return to. Therefore, during the execution of the called procedure, the *return address* must be stored somewhere out of reach of the current procedure but available immediately it has finished. Likewise any other special conditions which hold at the moment of the procedure call (e.g. the contents of some or all of the processor registers) must be preserved before the procedure is called and must be reinstated at the point of return.

In order to guarantee the preservation of this information, most modern processor architectures and language implementations provide the processor with a *run-time stack* for use as immediate *working space* during program execution. The essential feature of the

stack is that only the latest element *pushed* onto the stack is accessible to the processor and anything further down the stack is consequently “safe” from interference. The processor communicates with the stack through a *stack pointer* which contains the first free address above the top (i.e. latest) element on the stack. The processor can access the last element by *popping* it off the stack (and decrementing the stack pointer) or can push another element onto the stack (and increment the stack pointer).

Every operation which uses the stack must ensure that everything pushed onto the stack is popped off before it finishes. In this way when a procedure exits, it will leave the stack in exactly the state in which it found it. If the return address therefore was pushed onto the stack *before* the procedure was called, it can now be popped off, loaded into the program counter and processing can continue. The region of the stack *above* the return address becomes the current procedure’s private working space within which the local variables can be established and intermediate results can be stored. The diagram in Box 1 shows a representation of a stack when a nested procedure is being executed.

The current procedure can access any variables currently in the stack although when it exits its own local variables will be popped off the stack and hence lost.

Procedures that perform a job

The fact that the current procedure can access any variable on the stack and not just its own local variables is something of a mixed blessing. On the plus side, the current procedure will often require data from procedures further down the stack and it is convenient, in assignment statements and the like, to be able to refer to these variables in a straightforward way. On the minus side however, the further down the stack these variables are declared, the more searching and manipulation is required for each access. In addition, an assignment made to one of these non-local variables will stand even after the current procedure exits. This is known

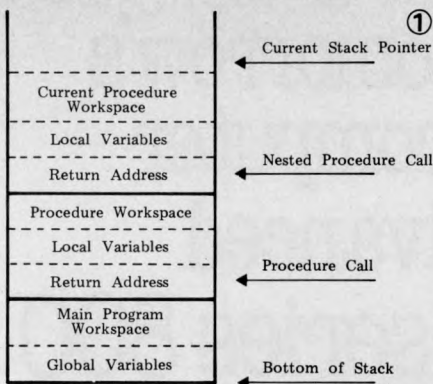

as a *side-effect* and is all very well if deliberately done by the programmer but a difficult error to trace if it happens inadvertently.

As a consequence it is necessary to make a distinction between those procedures which are required to produce a result and those which merely perform a job. A simple example of this latter category, with which we shall be concerned in this section, might be a procedure to print a line of dashes across a line-printer page. Such a procedure appears in Box 2 where PRINTLINE will produce the desired output when called from some other part of the program, as shown. The local variable I counts the number of dashes - 120 are printed out, this being the width of a typical line-printer page. However, some line-printers are 132 characters wide while matrix printers may have 40, 64, 72 and 80 character line widths, so if PRINTLINE were to be part of a package designed to run on a variety of systems, something would have to be done to customize (or personalize) the package to an individual user's system.

One approach would be to go through the code changing every occurrence of 120 to the desired value. This, of course, is time consuming, prone to errors of omission and not a serious option, particularly when an alternative is simply to create an integer variable (say LINEWIDTH) which the user is asked to set at the beginning of the program. All output can thence be customized to the terminal merely by *referencing* LINEWIDTH (e.g. line 6, Box 2 would read:

FOR I := 1 TO LINEWIDTH DO).

Since LINEWIDTH is a global variable it appears at the bottom of the stack and so is accessible to any procedure which is subsequently called. Provided the procedure only *uses* such non-local variables and doesn't change their values, this is a reasonably satisfactory way of allowing a procedure to communicate with external data.

Suppose, however, that one wished to write a procedure to produce a histogram, the data for which was stored in an array HEIGHT [1 .. 10]. Box 3 shows two methods of programming such a procedure. In program SIDEFFECT, procedure LINEOUT1 references the global array elements HEIGHT [I] and the global integer I. Consequently, each time HEIGHT [I] is needed, a search must be made, down to the bottom of the stack, first to find the value of I and then to get the contents of HEIGHT [I]. This must occur for ten iterations. In a large program where the arrays, procedures and hence the

```

1:  --
2:  --
3:  PROCEDURE PRINTLINE;
4:  VAR I: INTEGER;
5:  BEGIN
6:      FOR I:=1 TO 120 DO
7:          WRITE('-');
8:          WRITELN
9:      END;
10: BEGIN (*MAIN PROGRAM*)
11: --
12: --
13: --
14: IF LINENUM<60 THEN PRINTTEXT
15:     ELSE PRINTLINE;
16: --
17: --
18: --

```

```

1:  PROGRAM SIDEFFECT;
2:  VAR HEIGHT: ARRAY[1..10] OF INTEGER;
3:      I: INTEGER;
4:  --
5:  --
6:  (*PROCEDURE TO FILL HEIGHT*)
7:  --
8:  --
9:  PROCEDURE LINEOUT1;
10: BEGIN
11:     WHILE HEIGHT[I]>0 DO
12:     BEGIN
13:         WRITE('H');
14:         HEIGHT[I]:=HEIGHT[I]-1
15:     END;
16:     WRITELN
17: END;
18: --
19: --
20: BEGIN (* MAIN PROGRAM *)
21: --
22: --
23:     WRITELN('RESULTS HISTOGRAM:');
24:     FOR I:=1 TO 10 DO
25:     BEGIN
26:         IF I<10 THEN WRITE(' ');
27:         WRITE(I, '  ');
28:         LINEOUT1
29:     END;
30: --
31: ***-----***
32: PROGRAM CALLBYVALUE;
33: VAR HEIGHT: ARRAY[1..10] OF INTEGER;
34:     I: INTEGER;
35: --
36: --
37: (*PROCEDURE TO FILL HEIGHT*)
38: --
39: PROCEDURE LINEOUT2(J: INTEGER);
40: BEGIN
41:     WHILE J>0 DO
42:     BEGIN
43:         WRITE('H');
44:         J=J-1
45:     END;
46:     WRITELN
47: END;
48: --
49: BEGIN (* MAIN PROGRAM *)
50: --

```

Meet tomorrow's Microcomputer — the advanced **ACT series 800**

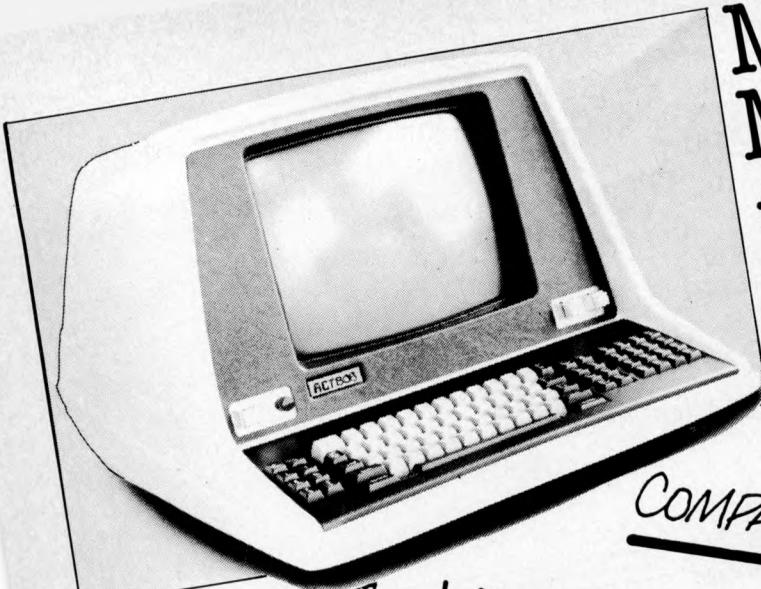

COMPARISON CHECK LIST

DATA	TYPICAL DESK TOP MICRO	ACT SERIES 800
1. High Resolution Graphics	X	✓ 122,880 addressable Points
2. Floppy Disk Storage	up to 1Mb	up to 4.8 Mb
3. Total Semi-Conductor Memory	up to 64Kb	up to 108Kb
4. Full Size Screen	X	✓ 1,920 Characters
5. Programmable Characters Standard	X	✓ 3 Complete Character Fonts
6. Data Transfer Rate from Disk	up to 8.5Kb per sec.	up to 15 Kb per sec.
7. National Field Service	X	✓

Tomorrow's
Micro built in
California by Compu-Think
Inc. for Act—Britain's leading
computing company

ACT SYSTEM 808—800Kb of disk storage
£3,950 + VAT

ACT SYSTEM 824—2.4Mb of disk storage
£4,950 + VAT

Complete business systems incorporating the Series 800 with Centronics Printers and
ACT's own Powerful Nebula 2 Software are also available. Prices correct at time of going to press.

ACT series 800

Complete the coupon for full details and the name of
your nearest dealer who can arrange an immediate demonstration.

My Name _____

My Address _____

Tel: _____

£19.45 p.w.*

*5 year lease. Shorter terms available.

ACT

MICROSYSTEMS

*Total
Computing*

Radcliffe House,
66-68 Hagley Road,
Edgbaston,
Birmingham B16 8PF.
Tel: 021-455 8686
Telex: 339396

Try the ACT 800 series computer at one of these dealers now:

LONDON
Lion House (Retail) Ltd.
 227 Tottenham Court Road, London W1P 0HX
 Tel: 01-580 7383

THE SOUTH
Petalect Electronic Services
 32 Chertsey Road, Woking, Surrey
 Tel: 04862-21776/23637

Business Electronics
 Rowhams House, Rowhams, Southampton
 Tel: 0703-734015

RUF Computers
 System House, Victoria Way, Burgess Hill, W. Sussex
 Tel: 04446-45211

T & V Johnson (Microcomputers) Ltd.
 165 London Road, Camberley, Surrey
 Tel: 0276-62506

South East Computers Ltd.
 4 Castle Street, Hastings, Sussex
 Tel: 0424-440099

HSV Business Systems Ltd.
 May Place, Basingstoke, Hants. RG21 1NX
 Tel: 0256 62444
 Southampton Street, Southampton, Hants.
 Tel: 0703 22131

Wilson Hughes and Partners (Data Sciences) Ltd.
 18 Chequers Square, Uxbridge, Middlesex UB8 1LN
 Tel: Uxbridge 53322

The Accounting House Ltd.
 54 London Road, Malden, Surrey SM4 5BA
 Tel: 01-640 9331
 Thyssen Rheinastahl House
 Molly Millars Lane, Wokingham, Berkshire RG11 2PU
 Tel: Wokingham 783434
 52 High Street, Chatham, Kent ME4 4DS
 Tel: Medway 402718

SOUTH EAST
Senodisk Ltd.
 34-36 St. Helens Road, Westcliff-on-Sea, Essex
 Tel: 0702-352590

The Computerist (Prorole Ltd.)
 642 London Road
 Westcliff-on-Sea
 Essex
 Tel: 0702-335298

SOUTH WEST
ACT Bristol Ltd.
 Graphic House, Telephone Avenue, Bristol BS1 4BS
 Tel: 0272-211733

EAST MIDLANDS
HB Computers
 22 Newland Street, Kettering, Northants.
 Tel: 0536-520910/83922

Lowe Electronics Ltd.
 Chesterfield Road, Matlock, Derbyshire DE4 3HE
 Tel: 0529-2817/2430

Arden Data Processing Ltd.
 Municipal Buildings, Charles Street, Leicester
 Tel: 0533-22255

Office Computer Techniques (Middletron)
 Highcroft, Husbands Bosworth, Lutterworth, Leics.

MMS (Steenmoor) Ltd.
 26 Mill Street, Bedford, Beds.
 Tel: 0234-40601

Caddis Computer Systems
 72-74 Trinity Lane, Hincly, Leics.
 Tel: 0455-613544

A.J.R. (Office Equipment) Ltd.
 5 Church Drive, Daybrooke, Nottingham NE5 6JP
 Tel: 0602-206647

Hallam Computer Systems
 1 Berkeley Precinct, 451 Eccleshall Road,
 Sheffield S11 8PN
 Tel: 0742-663125

EAST ANGLIA
Sumlock Bondain (East Anglia) Ltd.
 Grosvenor House, 32 Prince of Wales Road,
 Norwich, Norfolk
 Tel: 0603-26259

WEST MIDLANDS
Taylor Wilson Systems Ltd.
 Oakfield House, Station Road, Dorridge,
 W. Midlands B93 8HQ
 Tel: 021-560 6192

MERSEYSIDE
Stack Computer Services Ltd.
 290-298 Derby Road, Bootle, Merseyside L20 8LN
 Tel: 051-933 5511

D.A.M.S. (Office Equipment) Ltd.
 30-36 Dale Street, Liverpool 2
 Tel: 051-227 3301

Aughton Automation Ltd.
 Woodward Road, Kirby, Liverpool
 Tel: 051-548 6060

MANCHESTER
Cytek U.K. Ltd.
 12 Exchange Hall, Corn Exchange Building,
 Manchester M4 3EY
 Tel: 061-832 7604

SCOTLAND
Robox Office Equipment Ltd.
 Unit 14, Anderson Shopping Centre, Argyll Street,
 Glasgow G2 7PH
 Tel: 041-221 5401

```

51:      --
52:      WRITELN('RESULTS HISTOGRAM');
53:      FOR I:=1 TO 10 DO
54:      BEGIN
55:          IF I<10 THEN WRITE(' ');
56:          WRITE(I, ' ');
57:          LINEOUT2(HEIGHT[I])
58:      END;
59:      --
60:      --
    
```

Box 3 (continued)

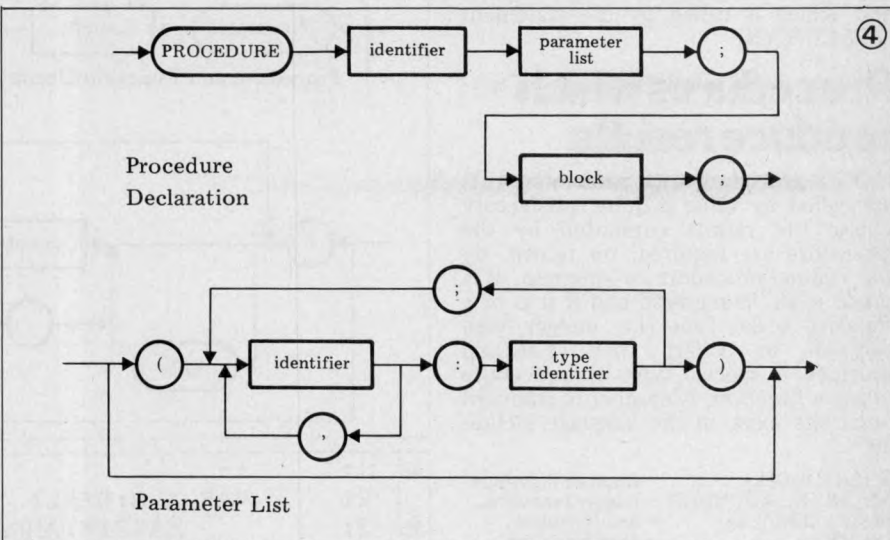

```

1:      --
2:      VAR EVEN:BOOLEAN;
3:      PROCEDURE PROCEVEN(VAL:INTEGER);
4:      BEGIN
5:          EVEN:=2*(VAL DIV 2)=VAL
6:      END;
7:      --
8:      --
9:      BEGIN (* MAIN PROGRAM *)
10:     --
11:     --
12:     PROCEVEN(VAL);
13:     IF EVEN THEN ....
14:     --
15:     --
***-----***
16:     --
17:     FUNCTION EVEN(VAL:INTEGER):BOOLEAN;
18:     BEGIN
19:         EVEN:=2*(VAL DIV 2)=VAL
20:     END;
21:     --
22:     --
23:     BEGIN (* MAIN PROGRAM *)
24:     --
25:     --
26:     IF EVEN(VAL) THEN...
27:     --
28:     --
    
```

stack itself can be expected to be much larger, the inefficiency of this method becomes amplified.

The second version of the program in Box 3 is intended to show how specific values may be passed to a procedure when it is called. This implies that the called procedure will make its own local copy of the value in its own work space at the top of the stack. Thus the call LINEOUT2 (HEIGHT [I]) in line 57

passes the actual parameter value (i.e. the contents of HEIGHT [I]) to produce LINEOUT2 which uses the local formal parameter J to reference that value. Every time J is accessed it can be found at the top of the stack so the search is shorter than the corresponding search in program SIDEFFECT. LINEOUT2 alters the value of J as it proceeds but this change does not affect HEIGHT [I] since, when LINEOUT2

exits all its work space (including the current value of J) is returned to the free space above the top of the stack.

This technique of passing useful external values to a procedure for use in its own work space is known as a *call-by-value*. The formal definition is shown in the syntax diagram in Box 4. Note that formal parameters may be of any type and that more than one may be passed.

Exercise: Write a procedure which will cause the line printer to skip 'm' lines and which is called by the statement NEWLINE (N)

Procedures which produce results

Using a procedure with parameters that are called by value is quite satisfactory unless the results computed by the procedure are required, on return, by the calling procedure or program. If a *single* result is required and if it is of a *standard* scalar type (i.e. integer, real, Boolean or Char) then PASCAL provides a special type of procedure called a *function*. A number of standard functions exist in the language including:

- EOLN, ODD(X) — Boolean functions
- TRUNC(X), ROUND(X) — integer functions
- SIN(X), SQRT(X) — real functions
- CHR(X) — char functions

The syntax diagram for user-defined functions is given in Box 6.

For other procedures, the procedure call is a complete statement consisting of the procedure identifier followed by the list of actual parameters. Since the result returned by a function is a single standard type, the function call can be made implicitly by using the function name directly in the statement within which the returned result is required. Thus

```

REPEAT
  —
  —
UNTIL EOLN
  
```

where EOLN represents a function call returning a result of TRUE or FALSE; and

```
WRITE(SIN(X))
```

where the SIN function returns the result which is printed out. User-defined functions can be referenced in exactly the same way and the standard functions can even be overridden within a program by a user-defined function of the same name.

Compare the two segments of code in Box 5, which represent different approaches to the same task — to determine whether a given integer is even or not. When PROCEDURE is used a global Boolean variable EVEN must be declared. This is set to TRUE or FALSE within PROCEDURE depending on the nature of the indicated integer. In the second case, the *function* EVEN is set to TRUE or FALSE. This is made possible in line 17 where the function *itself* is declared as a Boolean (see also the syntax diagram in Box 6). In both cases the integer VAL is passed and in both cases an assignment is made to the identifier EVEN. This is an important

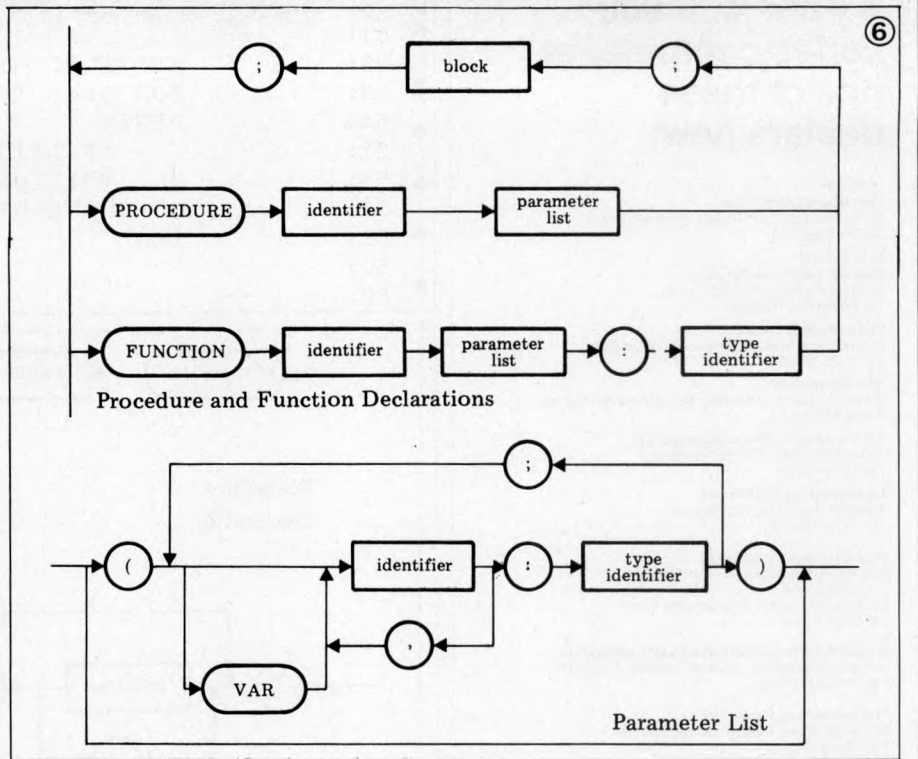

```

1:      --
2:      VAR A, B: REAL;
3:      MATRIX: ARRAY[1..50] OF REAL;
3:      PROCEDURE BADSWAP;
4:      VAR TEMP: REAL;
5:      BEGIN
6:          TEMP := A;
7:          A := B;
8:          B := TEMP;
9:      END;
10:
11:     BEGIN (* MAIN PROGRAM *)
12:     --
13:     --
14:         A := MATRIX[I];
15:         B := MATRIX[K];
16:         BADSWAP;
17:         MATRIX[I] := A;
18:         MATRIX[K] := B;
19:     --
20:     --
21:     ****-----****
22:     VAR MATRIX: ARRAY[1..50] OF REAL;
23:
24:     PROCEDURE SWAP(VAR A, B: REAL);
25:     VAR TEMP: REAL;
26:     BEGIN
27:         TEMP := A;
28:         A := B;
29:         B := TEMP;
30:     END;
31:
32:     BEGIN (: MAIN PROGRAM :)
33:     --
34:     --
35:         SWAP(MATRIX[I], MATRIX[K]);
36:     --
37:     --
  
```

feature of functions — an assignment must be made to the function identifier before control returns to the calling procedure. Finally, the concise nature of

the function call (line 26) should be compared with the more unwieldy version in lines 12 and 13.

Functions, for all their attractions,

can still only return single scalar values, so PASCAL provides a different means of returning multiple scalar values on structured data types (arrays, records, etc). While the ordinary type of procedure call is employed, the call-by-value mechanism can only pass data to the procedure. A second mechanism exists whereby variables declared in the formal parameter list are marked for return to the calling procedure. The method of so marking parameters consists of preceding each variable name (or sequence of variable names) to be returned with the reserved word VAR, as shown in the syntax diagram in Box 6. These are consequently known as *variable* parameters in contrast to the *value* parameters defined in the previous section. The calling mechanism is often referred to as a *call-by-name*.

The action taken by the compiler to achieve this two-way passing of data is quite complex. Provision must be made so that references to the formal parameter in the current procedure can be connected back to the actual parameter in the stack area of the calling procedure. Although the compiler must make these arrangements, the connections are made at run-time since the compiler does not always "know" where the actual parameter is. The classic example of this circumstance occurs when the actual parameter is an array element. Which particular array element is passed depends on the array indices whose values are not known to the compiler. Before the called procedure is activated

therefore, the required array element must be identified and connected with the formal parameter name at the top of the stack.

As an example of a procedure using the *call-by-name* approach, compare the two segments of code in Box 7. Both are designed to achieve the exchange (or swapping) of the values of two reals. Procedure BADSWAP achieves this by side-effect and requires two global reals A and B to be declared in the main program. If any other reals (apart from A and B) need to be swapped, then their values must be assigned to A and B before BADSWAP is called and retrieved once control has returned to the calling procedure (lines 14 to 18). In contrast, procedure SWAP contains the variable parameters A and B and any two reals in the calling procedure (lines 14 to 18). In contrast, procedure SWAP contains the variable parameters A and B and any two reals in the calling procedure can be passed and returned directly (line 35). Note that there is no reference to the variables A and B in the calling procedure declaration which implies that procedure SWAP could be inserted into any number of different programs without demanding that any external code be changed.

In this fashion it is possible for a programmer to build up a library of useful procedures which can operate independently of the calling program provided that there is a direct type correspondence between the actual and the formal parameters to avoid having

to think about the precise role of each variable in the procedure. However, while this approach may be easier it is not usually more efficient due to the connection activity required to link formal and actual parameters. An exception to this condition occurs when a large data structure is required in a called procedure. The time (and space) taken in creating a fresh copy at the top of the stack will often outweigh the time lost in searching out those elements required in the procedure.

String handling

The next chapter will be concerned with the development of a text formatting program in the course of which a large amount of string manipulation is going to be required. In preparation for this program, Box 8 contains a set of functions and procedures which provide basic string handling facilities. The UCSD PASCAL system provides a similar set of functions and procedures to facilitate this kind of programming. UCSD has had to define an extra data type the STRING (= PACKED ARRAY [1 .. 80] OF CHAR) so that the function calling (and returning) mechanism will work. Since we are concerned in this series merely with using PASCAL compilers and not writing them, we must be content with a more pedestrian set of procedures.

In particular we have had to write procedures instead of UCSD string functions *continued on page 101*

SUBSCRIPTIONS BINDERS KEEPERS LOSERS WEEPERS

Just over 2 years ago PCW became the first magazine in Europe to deal exclusively with the home and business use of Personal Computers. It has been an unqualified success. The current subscription list stands at well over 3,000, with a staggering 70% renewal rate! PCW reader loyalty is already a byword in the publishing business. We aim to keep it that way. So if you are having difficulty in obtaining PCW at your newsagent, why not take out a subscription and have the magazine mailed to you direct?

Half the people you meet today are not preoccupied with pollution, perversion or persecution. It's worse than that — they've lost a copy or two of PCW and don't know where to find replacements.

So keep *your* copies of PCW in a beautiful bright blue binder. £2.95 worth of smart security.

Just check the coupon at the foot of the page.

Personal Computer World

UK Subscriptions: £8.00
USA Subscriptions: £22.00 (airmail)
Europe Subscriptions: £13.00 (airmail)
Elsewhere: £25.00 (airmail)
Binders: £2.95

Please send me the next 12 issues of PCW

Please send me PCW Binders

NAME _____

ADDRESS _____

(Block capitals please)

I enclose cheque/P.O. for £ _____ made payable to
Sportscene Publishers Ltd.

Send coupon to PCW (Subscriptions), 14 Rathbone
Place, London W1P 1DE. Allow at least 14 days for
processing.

PROGRAMMING - THE SIMPLE APPROACH

Mervyn Axson leads you gently through the minefield of writing your first "real" programs in BASIC. Suitable for businessmen as well as hobbyists, you need only a nodding acquaintance with the language and access to a machine in order to start.

The operations to be performed in most business programs are very simple, so the programming should also be simple. You may doubt the truth of this if you look at a listing of a program, for at first sight it probably appears to be very complicated. If, however, you examine it bit by bit, you will find that it really is quite simple. I'll be tackling the problem in the reverse way, by writing a very basic program, and then refining it step by step to show how it ends up looking complicated. And by the way, although the program will be written in PET's version of BASIC, it can easily be modified to suit other machines.

A problem common to many businesses is that of quoting credit terms to prospective customers. Let us suppose that we require a minimum deposit of 10% and that the credit charges are at the rate of 12½% per annum calculated on the balance remaining after payment of the deposit. The query is: "What are the terms for good costing £399.95 over 18 months?". The calculations are not difficult, although perhaps tedious.

Now we have to consider how to write the computer program to carry out these operations for us. Actually, the simple answer is that we have already done so, for these are all valid BASIC statements! We only have to add line numbers and allow for inputting Sum, Interest Rate and Period, and outputting Deposit and Monthly repayment. Our completed program reads:

```
10 INPUT S
20 INPUT I
30 INPUT P
40 D = S/10
50 B = S - D
60 C = B * (I/100 * (P/12))
70 A = B + C
80 R = A/P
90 PRINT D
100 PRINT R
```

Note that this short and simple program is complete in itself and will give the required answers for any values that you wish to input. You could stop here, since most of the refinements to be added are largely cosmetic in that they do not improve on the basic function,

Deposit = £399.95 divided by 10 = £40.00
 Balance = £399.95 minus £40.00 = £359.95
 Charges = Balance multiplied by interest rate multiplied by period.
 Interest rate = 12½% p.a. the period = 18 months.
 The rate to be applied = 12½% * 1.5 = 18¾%
 So charges = £359.95 multiplied by 18.75/100 = £67.49
 Amount to be repaid = balance plus charges = £359.95 plus £67.49 = £427.44.
 Divide this last figure by 18 to find the monthly payment which is £23.75.

So for the general case we can say:

Deposit = Sum/10
 Balance = Sum - Deposit
 Charges = Balance * (Interest * Period/12)
 Amount to be repaid = Balance + Charges
 Repayments = Amount to be repaid/Period.

or, just using initials:

D = S/10
 B = S - D
 C = B * (I/100 * (P/12))
 A = B + C
 R = A/P

but merely give a better appearance to the output, or make the program easier to use. Of course, in business, these factors can be very important.

What happens if we load the program into PET and then type RUN? PET responds with a "?" so type in the sum (followed by pressing the RETURN key, of course). Another "?" appears, and you type in the interest rate, and finally in response to a third "?" you type in the period. PET now displays the answers, and the screen looks like this:

```
RUN
? 399.95
? 12.5
? 18
39.995
23.7470313
```

We would of course mentally round the 39.995 to 40.00 and 23.7470313 to 23.75, but we can easily make PET do it for us. $INT(X*100+.5)/100$ will round X to 2 decimal places. In this program we only need to use this twice, but in others we have to use it many times so to save typing we can use the DEF statement:

```
5 DEF FNA(X) = INT(X*100+.5)/100
and then
```

```
90 PRINT FNA(D)
100 PRINT FNA(R)
```

will produce the required result.

It would be helpful if PET told us what input it wanted rather than just printing "?". INPUT statements allow us to do this. If we amend line 10 to:

```
10 INPUT "COST OF GOODS" ; S
```

PET will now print:

```
COST OF GOODS?
Lines 20 and 30 can also be modified similarly, and lines 90 and 100 can be altered to:
90 PRINT "DEPOSIT";FNA(D)
100 PRINT P; "MONTHLY PAYMENTS OF";FNA(R)
```

The output will now be:

```
DEPOSIT 40
18 MONTHLY PAYMENTS OF 23.75
```

This is beginning to look better, but there is still a lot that can be done to improve it. Showing the Deposit as 40 rather than 40.00 is annoying to say the least. BASIC does this to all numbers, dropping zeros that are not significant. Typing PRINT 40.10 will produce 40.1 and PRINT 00123 results in 123. There is a fairly simple way round this problem, although it looks complicated! We convert our simple number to a string which can then be "formatted" to produce the desired result and then printed. We will probably need to use this many times in a lot of business programs, so we can write the program section as a subroutine which we can call up whenever required.

This is:

```
10000 Z$ = STR$(Z)
10010 L = LEN(Z$)-2
10020 IF L = 0 THEN 10060
10030 IF MID$(Z$,L,1) =
      "." THEN 10090
10040 L = L+1
10050 IF MID$(Z$,L,1) =
      "." THEN 10080
10060 Z$ = Z$+"."00"
```

```
10070 GOTO 10090
10080 Z$ = Z$+"0"
10090 RETURN
```

The number to be printed is returned as Z\$, but before we amend the program, there is one further point in formatting. The result would be clearer if the amounts were set out thus:

```
DEPOSIT                40.00
18 MONTHLY PAYMENTS OF 23.75
```

Whilst in this case a simple TAB(30) instruction would be satisfactory, it would not if the deposit was 10.00 and payments 9.95:

```
DEPOSIT                10.00
18 MONTHLY PAYMENTS OF  9.95
```

There is a very simple way to align the numbers. They are in string form so LEN(Z\$) works out how long they are and TAB (30 - LEN(Z\$)) will ensure that they are lined up.

Now the program reads:

```
88 Z = FNA(D)
89 GOSUB 10000
90 PRINT "DEPOSIT";
   TAB(30-LEN(Z$));Z$
98 Z = FNA(R)
99 GOSUB 10000
100 PRINT P;"MONTHLY PAYMENTS
   OF";TAB(30-LEN(Z$));Z$
```

We now have a fairly presentable result on PET's VDU. A few PRINT statements judiciously inserted would make it even better, since for example, a simple 91 PRINT will put a line space between DEPOSIT and 18 MONTHLY PAYMENTS, making the result easier to read. We want this program to provide clear answers for the novice, so what else should we do? For a start, it would help them to know that they had loaded the correct program into PET. 4 PRINT "LOAN SCHEME" will reassure them. Then we could clear the VDU screen when we have input the data so that the answers alone are shown. PRINT CHR\$(147) will clear the screen and as we have now lost the input data perhaps we should also display the cost of the goods in the output.

```
81 PRINT CHR$(147)
82 PRINT "LOAN SCHEME"
83 PRINT
84 Z = FNA(S)
85 GOSUB 10000
86 PRINT "COST OF GOODS";
   TAB(30 - LEN(Z$)); Z$
87 PRINT
```

Just for one moment, let us suppose that we are now satisfied with our efforts and that we think the program to be complete. We "RUN" it with the sample data mentioned before and PET immediately displays:

```
LOAN SCHEME
COST OF GOODS          399.95
DEPOSIT                40.00
18 MONTHLY PAYMENTS OF 23.75
```

We now write down the figures and return to the customer and proudly announce the results. Our efficiency must be obvious and surely we will make the sale? Alas, real life is not like that and we are soon deflated by the response is: "Oh! I can pay £100.00 down, so what would that make the monthly payment?" The program that we have written does not allow for this

situation, so we are back to calculations — or are we? No, because in the light of experience, we could modify the program. Instead of using line 40 to calculate the deposit, we could make an input of the deposit offered:

```
40 INPUT "DEPOSIT OFFERED";D
```

However, think for a minute; sometimes the response to the question: "What deposit do you want to pay?" will not be a definite figure but "What is the least that you require?" We can cater for both responses simply by adding:

```
31 INPUT"DEPOSIT OFFERED ?
   IF LOWEST TYPE MIN";D$
32 IF D$ = "MIN" THEN 40
```

We have made the variable D\$ rather than D to cater for the input of MIN. If it is, then line 32 continues the program as before. But if D\$ represents an amount e.g. 100.00, then we must convert this from a string variable D\$ to a numeric variable D. D = VAL(D\$) will do this and we can then go straight to line 50.

It could happen that the deposit offered was less than the minimum required and this may not be noticed; we can add a line to take care of this as well.

```
33 D = VAL(D$)
34 IF D<S/10 THEN PRINT "MINIMUM
   DEPOSIT IS";FNA(S/10):GOTO 31
35 GOTO 50
```

If you try running the program now, you will find that whilst it produces the required result, it also ends by printing RETURN WITHOUT GOSUB ERROR. This is because after line 100, which is the end of the program so far, PET "falls through" to the subroutine in 10000 on. A simple line 9999 END will prevent this. We could usefully clear the screen before any input is requested, so line 3 PRINT CHR\$(147) can be added.

The listed program does now begin to look rather more complicated, but by taking it a step at a time, it's been written quite painlessly. And what's more, we have a program which has been capable of being used at any stage in its development — which is by no means completed yet. How about adding the facility of being able to output the payments required for all of the periods we offer, which could typically be 12, 18, 24, 30 and 36 months? We will tackle this and other developments in the next section. In the meantime, we have a quite useful program already. In a business situation it is often import-

• 3 PRINTCHR\$(147)	First listing of program 'LOAN SCHEME'	•
• 4 PRINT"LOAN SCHEME"		•
• 5 DEFFNA(X)=INT(X*100+.5)/100		•
• 10 INPUT"COST OF GOODS";S		•
• 20 INPUT"INTEREST RATE";I		•
• 30 INPUT"PERIOD";P		•
• 31 INPUT"DEPOSIT OFFERED ? IF LOWEST TYPE MIN";D\$		•
• 32 IFD\$="MIN"THEN40		•
• 33 D=VAL(D\$)		•
• 34 IFD<S/10THENPRINT"MINIMUM DEPOSIT IS";FNA(S/10):GOTO31		•
• 35 GOTO50		•
• 40 D=S/10		•
• 50 B=S-D		•
• 60 C=B*(I/100*(P/12))		•
• 70 A=B+C		•
• 80 R=A/P		•
• 81 PRINTCHR\$(147)		•
• 82 PRINT" LOAN SCHEME"		•
• 83 PRINT		•
• 84 Z=FNA(S)		•
• 85 GOSUB10000		•
• 86 PRINT" COST OF GOODS";TAB(30-LEN(Z\$));Z\$		•
• 87 PRINT		•
• 88 Z=FNA(D)		•
• 89 GOSUB10000		•
• 90 PRINT" DEPOSIT";TAB(30-LEN(Z\$));Z\$		•
• 91 PRINT		•
• 98 Z=FNA(R)		•
• 99 GOSUB10000		•
• 100 PRINTP ;"MONTHLY PAYMENTS OF";TAB(30-LEN(Z\$));Z\$		•
• 9999 END		•
• 10000 Z\$=STR\$(Z)		•
• 10010 L=LEN(Z\$)-2		•
• 10020 IFL=0THEN10060		•
• 10030 IFMID\$(Z\$,L,1)="."THEN10090		•
• 10040 L=L+1		•
• 10050 IFMID\$(Z\$,L,1)="."THEN10080		•
• 10060 Z\$=Z\$+".00"		•
• 10070 GOTO10090		•
• 10080 Z\$=Z\$+"0"		•
• 10090 RETURN		•



Micro-Computer Centre for the MIDLANDS

Nascom and Commodore Specialists

A full range of micro computers and peripherals are available, whether buying or browsing we can give helpful and friendly advice.

Nascom 2 complete kit ex. stock £295.00 + VAT or fully built and tested £335.00 + VAT.

Nascom 1 super new low prices £125.00 + VAT or fully built and tested £140.00 + VAT.

This has to be the best starting point for anyone interested in Micro Computing.

We are now sole distributors for the Micro Type case for your Nascom 1 & 2, also stockists of the William Stuart colour graphics and full range of add ons.



Business & Leisure Micro Computers

16 The Square, Kenilworth, Warwickshire CV8 1EB.

Tel: (0926) 512127

E.G.A

GAMES FOR YOUR APPLE

Individual games on Disk or Tape.
All games to suit your configuration.

1 Chess 1	5 Levels	£35.00	11 Mastermind	£25.00
2 Chess 2	10 Levels	£45.00	12 Racing Driver	£25.00
3 Breakout I		£45.00	13 Hangman	£25.00
4 Super Breakout 2		£55.00	14 Computer Thinks	£25.00
5 Alien Invaders I		£40.00	15 Rocket Pilot	£25.00
6 Star Trek		£43.00	16 Othello	£25.00
7 New York Stock Market		£30.00	17 Pong	£25.00
8 Dragons Maze		£25.00	18 Pontoon	£25.00
9 Bio - Rhythms		£25.00	19 Music. Any Tune.	£25.00
10 Super Maths		£25.00	20 Star Wars	£25.00

Mail Order

Written order with cheque or postal orders to :
52 Sutherland Square, Walworth Road, London.
S. E. 17. 3 E L.

Please Supply :

Item : _____ Quantity : _____
 Amount £ _____ Cheque No : _____
 Name : _____
 Address : _____
 Telephone No : _____

DISCOUNT PETS

NEW 8K PET £470 with large keyboard,
 16K £550, 32K £650, Dual Floppy £680,
 Programmer's Toolkit £45, Cassette £50.
 BASE 2 PRINTER £475 compatible with PET
 3 Interfaces: IEEE, RS232, Centronics parallel,
 3 Character fonts - one downloadable,
 programmable horizontal & vertical densities,
 stepping motor, tractor feed, contiguous plotting.

TEXAS TI 99/4 £890 with 13" colour monitor.
The most advanced home computer.

AIM 65 4K SYSTEM £420 cased, powered & with assembler and BASIC. Also memories & motherboards for AIM 65/KIM by Seawell.
Disk system (2 x 5" drives) with DOS £800.

S-100 SYSTEM £1000 based on North Star with single disk drive, Z-80, 2 ports, 32K memory, completely assembled and tested. Runs all North Star software.

NORTH STAR HORIZON II £1400

S-100 BOARDS assembled and tested only.
16K fully static 2MHz memory with bank select, optional wait states, write protect etc. £150
4MHz £250. Jade 4MHz A-80 CPU £140.
SD PROM-100 EPROM programmer £140. 2 serial & 1 parallel I/O card £120.

SOFTWARE

PAYROLL for NORTH STAR on two disks £56. (also for PET, Listing only £50.

SUPER BLAKE 7 game for NORTH STAR/PET on disk £13, for Challenger 8" disk £15, PET cassette £15, listing only £10.

Send for list or call:



CAMBRIDGE ROAD, ORWELL,
ROYSTON, HERTS.
Telephone: Arrington 689

North Star ★ BUSINESS SOFTWARE

Sales Ledger Nominal Ledger Inventory & Invoicing Purchase Ledger

- * easy to use
- * fully documented
- * simple operator interface
- * alphanumeric stock Part Numbers
- * fully integrated or stand alone
- * full validation and range checking

The system is generated to meet individual customer requirements.

A typical two disk system will hold:-

200 accounts	500 account transactions
99 rep/agents	99 sales codes
150 nominals	99 nominal heads
500 nominal transactions	350 stock items
75 supplier orders	200 order transactions
100 suppliers	300 supplier transactions

Price: £950 plus VAT

Complete business system £3600 plus VAT

BENCHMARK COMPUTER SYSTEMS LIMITED
Tremena Manor, Tremena Road,
St. Austell, Cornwall PL25 5QG
Telephone: 0458/43418 :0761/62435 :0726/61000

ant to get some useful programs running as quickly as possible, so as to convince the sceptics of the value of the system in which they've invested.

The next stage in developing our loan scheme program is to add the option of calculating the payments required for all the periods we offer, which we will take to be 12, 18, 24, 30 and 36 months. This will enable us to answer the general query: "What are your terms for -----?" quickly and comprehensively. This development does need a bit of thinking about. The input is easy, being very similar to that used for the deposit option. We shall have to alter some line numbers for reasons that will appear later, so delete line 30 and write:

```
25 INPUT "PERIOD ?
IF ALL TYPE ALL";P$
26 IF P$<>"ALL" THEN P = VAL(P$)
```

Now we either have a single value for the period in P or we have "ALL" in P\$. If the former, then the program as it stands will work; but what changes are needed to cope with the latter? What we have to do is to run through lines 60, 70 and 80 for each value of the period. This obviously calls for a "FOR ----- NEXT" loop. BASIC does allow us to specify the step between values, as well as the start and finish, so FOR P = 12 TO 36, STEP 6 will successively give the correct values to P. But what happens in line 80? Each time we run through the loop a new value will be calculated for R which will replace the previous one, so when we exit from the loop the only value of R available is the last one i.e. R for 36 months. Obviously, we must arrange to save the value of R each time it is calculated. Fortunately, BASIC provides an easy way to do this, although you may not think so from the jargon, for we construct an array using a single subscripted variable (or something like that)! All this actually means is that we save the first result as variable R(1), the second as R(2) and so on. The program changes the number in brackets, the subscript, each time we go round the loop, the result being that our five values for R are all saved as R(1) to R(5).

How do we write the program to perform these operations? We will use J to keep track of the subscript and first we give it the value of 1, 55 J = 1, then we set up the loop, 57 FOR P = 12 TO 36 STEP 6. Lines 60 and 70 remain the same, but we alter 80 to R(J) = A/P and give it the new line number of 77. R(1) now has the value of R when P = 12. J now has to equal 2 so 79 J = J+1. We now have to go back to the beginning of the loop, line 57, to do the calculation for P = 18. 80 NEXT will accomplish this, and since J now equals 2, the result will be saved as R(2). This will be repeated until all five results have been saved and we exit from the loop to line 81.

We have now dealt with the case when P\$ = "ALL", but what when P has a single value? This would work previously, but now we have altered the program by putting in a loop — which in this instance we don't need! We must miss out the loop instructions and a couple of IF THEN statements in lines 56 and 78 will be sufficient. The complete section of the

program now reads:

```
55 J = 1
56 IF P$<>"ALL" THEN 60
57 FOR P = 12 TO 36 STEP 6
60 C = B * (I/100(P/12))
70 A = B + C
77 R(J) = A/P
78 IF P$<>"ALL" THEN 81
79 J = J + 1
80 NEXT
```

This may seem a little complicated at first, but once you get the idea it is really quite simple. It's well worth making the effort to fully understand it, since it is a technique that is very valuable in many business programs, where the ability to perform repeated calculations and later recall the results is a necessity.

We have just mentioned recalling the results, so how do we do that to produce our output. Very simply, just by using the same technique.

```
95 J = 1
96 IF P$<>"ALL" THEN 98
97 FOR P = 12 TO 36 STEP 6
98 Z = FNA(R(J))
99 GOSUB 10000
100 PRINT P; "MONTHLY PAYMENTS
OF"; TAB(30 - LEN(Z$));Z$
```

```
101 PRINT
102 IF P$<>"ALL" THEN 9999
103 J = J + 1
104 NEXT
```

You may remember that we left a few spare lines after inputting the period. This is to allow us to check that the data input is valid. As the program stands, it will perform the calculations for any period of months typed in, even 1 or 1000. Admittedly, these are unlikely errors, but 21 instead of 12 or 42 instead of 24 are very possible. There are many ways in which we carry out this check, but a simple one can be based on the fact that all the valid periods can be divided by 6, resulting in whole numbers (integers) ranging from 2 to 6. We can code this in BASIC in two lines. IF P/6 < INT(P/6) THEN "ERROR" checks for whole numbers e.g. 21/6 = 3.5 an error. 42/6 = 7 will pass this test but will fail IF P/6 < 2 OR P/6 > 6. Actually, as often happens, the program becomes a little simpler if we reverse the last test to IF P/6 = <6 AND P/6 = 2 THEN "PROCEED AS NORMAL". An error e.g. 42/6 = 7 will then carry on to the next statement which is the error message, so saving another jump statement.

Sample runs of program "LOAN SCHEME"		
LOAN SCHEME QUOTATION BY C.AXSON & SONS		
COST OF GOODS	399.95	
DEPOSIT	40.00	
18 MONTHLY PAYMENTS OF	23.75	INCLUDING CHARGES OF 67.49
LOAN SCHEME QUOTATION BY C.AXSON & SONS		
COST OF GOODS	659.00	
DEPOSIT	159.00	
12 MONTHLY PAYMENTS OF	46.88	INCLUDING CHARGES OF 62.50
18 MONTHLY PAYMENTS OF	32.99	INCLUDING CHARGES OF 93.75
24 MONTHLY PAYMENTS OF	26.04	INCLUDING CHARGES OF 125.00
30 MONTHLY PAYMENTS OF	21.88	INCLUDING CHARGES OF 156.25
36 MONTHLY PAYMENTS OF	19.10	INCLUDING CHARGES OF 187.50

```

● 3 PRINTCHR$(147)
● 4 PRINT"LOAN SCHEME"
● 5 DEF FNA(X)=INT(X*100+.5)/100
● 10 INPUT"COST OF GOODS";S
● 20 INPUT"INTEREST RATE";I
● 25 INPUT"PERIOD ? IF ALL TYPE ALL";P$
● 26 IF P$<>"ALL" THEN P=VAL(P$):GOTO 28
● 27 GOTO 31
● 28 IF P/6<>INT(P/6) THEN 30
● 29 IF P/6=<6 AND P/6=2 THEN 31
● 30 PRINT"INVALID PERIOD":GOTO 25
● 31 INPUT"DEPOSIT OFFERED ? IF LOWEST TYPE MIN";D$
● 32 IF D$="MIN" THEN 40
● 33 D=VAL(D$)
● 34 IF D<S/10 THEN PRINT"MINIMUM DEPOSIT IS";FNA(S/10):GOTO 31
● 35 GOTO 50
● 40 D=S/10
● 50 B=S-D
● 55 J=1
● 56 IF P$<>"ALL" THEN 60
● 57 FOR P=12 TO 36 STEP 6
● 60 C(J)=B*(I/100*(P/12))

```

Loan scheme — final version

PO Box 2
St Neots
Cambridgeshire

Dear Sir

The benefits of word processing are here for all!

The **Comart VDM** Video Display Module plugs easily into the North Star Horizon Computer S100 Bus and, together with the Comart Monitor and VDM *Star word processing software, provides the facilities of "instant display" word processing on a general purpose microcomputer.

Text may be entered, edited and standard paragraphs inserted with true upper & lower case display then rapidly printed in your chosen format.

The VDM transforms the Horizon into a valuable word processor yet change the diskette software and it resumes its role as a general-purpose Computer **Real Flexibility!**

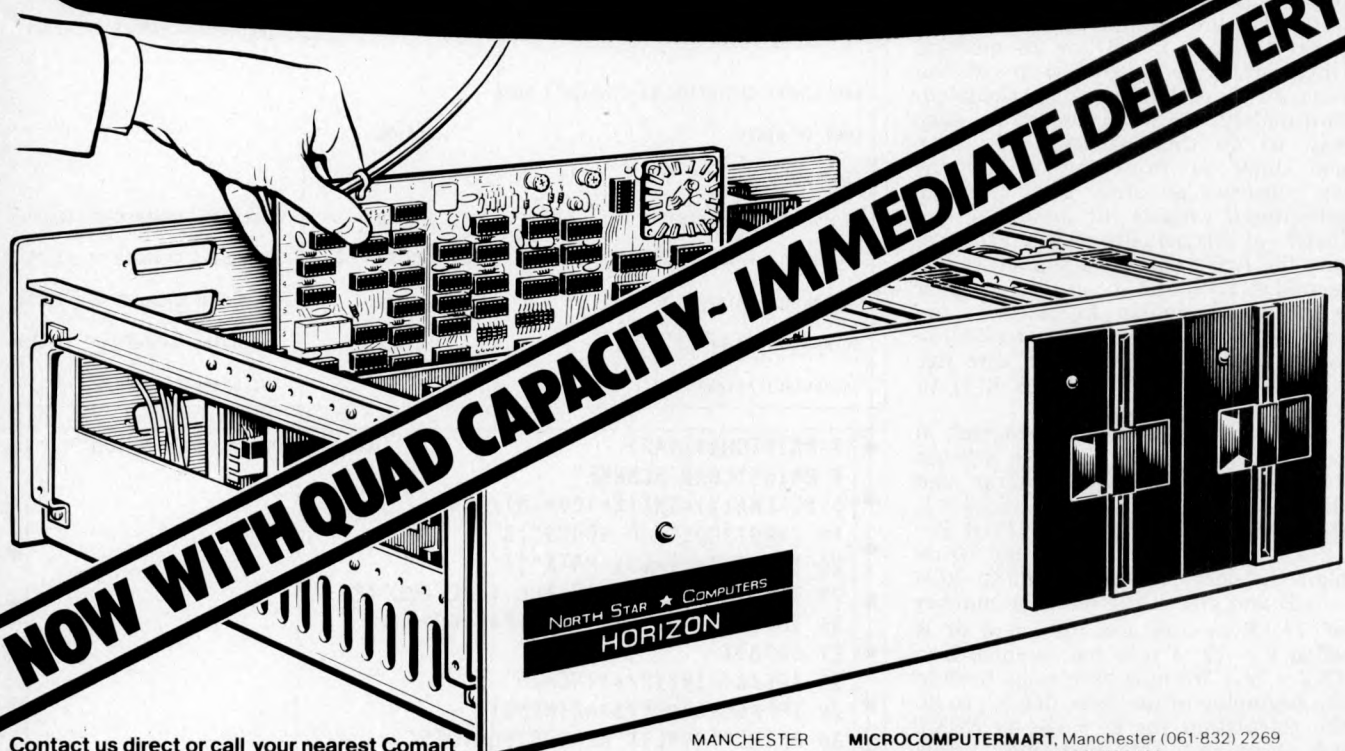

Contact us direct or call your nearest Comart dealer

CAMBRIDGE
CAMBERLEY
ILFORD

LEEDS

LONDON
LUTON

CAMBRIDGE COMPUTER STORE, Cambridge (0223) 68155
MICROBITS, Camberley, Surrey (0276) 34044
THE BYTE SHOP, Ilford, Essex 01-554 2177
also at Tottenham Court Road, London 01-636 0647
HOLDENE LIMITED, Leeds (0532) 459459
also at Wilmslow, Cheshire (0625) 529486
DIGITUS LIMITED, London W1 01-636 0105
ISHERWOODS, Luton, Bedfordshire (0582) 424851

MANCHESTER

NEWBURY

NEWPORT
NOTTINGHAM

SHEFFIELD
SOUTHAMPTON

MICROCOMPUTERMART, Manchester (061-832) 2269
also at West Park, Leeds (0532) 788466
NEWBEAR COMPUTING STORE, Newbury, Berks (0635) 30505
also at Stockport, Cheshire (061-491) 2290
MICROMEDIA SYSTEMS, Newport, Gwent (0633) 50528
COMPUTERLAND LIMITED, Nottingham (0602) 40576
also at Birmingham (021-622) 7149
Manchester 061-236 4737
Glasgow (041332) 2468
HALLAM COMPUTER SYSTEMS, Sheffield (0742) 663125
XITAN SYSTEMS LIMITED, Southampton (0703) 38740



comart specialists in microcomputers

Comart Ltd., P.O. Box 2, St. Neots, Huntingdon, Cambs, PE19 2AF. Tel: (0480) 215005 Telex: 32514

The coding now is:

```
28 IF P/6 <> INT(P/6) THEN 30
29 IF P/6 = (6 AND P/6)=2 THEN 31
30 PRINT "INVALID PERIOD" : GOTO 25
```

There is one further valuable addition we could make to the program, and that is to give the option of having the output printed out. Devices external to PET are given numbers and that for a printer is usually 4. To output to the external device, a file is opened — OPEN 1,4 is the code. Now any statement starting PRINT #1, will cause the output to be sent to that device. So after enquiring whether the option is wanted and receiving the answer "yes" we run through a series of statements identical to lines 82 to 104 but with PRINT #1, instead of PRINT. Actually, they are not quite identical for you will notice that the TAB instructions are slightly different. This is caused by the way the printer used, a Teletype 43, responds to the TAB instruction. On PET, TAB(30) causes printing to start in the 30th print position from the beginning of the line, but on the Teletype TAB(30) causes printing to start in the 30th print position from where the print head is situated. This means that if we have already printed DEPOSIT, printing will start in print position 37 and not 30 as required. We therefore have to deduct the length of any items already printed, including spaces between words, from the required position number e.g. TAB(23) after DEPOSIT.

Another addition has been made to the printed output. If the quotation is given to the customer, we should show the credit charges which would be made in each case for the differing periods. This information is present in variable C and we can use the same technique to preserve the values as we did for R, i.e. C(J) is substituted for C in lines 60 and 70. For clarity we want to print the credit charges on the same line as the repayments, but we cannot give the instructions in the same statement line since we have to GOSUB to format C(J). By ending the payment print instruction with a ";" we suppress the carriage return and line feed, so achieving our object. The only other alteration to the program occurs in line 102 where we alter THEN 9999 to THEN 110 to give the printed output option.

We now have a fairly comprehensive answer to our problem, which even the most inexperienced junior can use to give quick and accurate answers to queries. The full listing does show quite a complicated piece of programming, and I certainly would not like to have to sit down write it all at one go. However, I hope you have seen that it really is not all that complicated if broken down into steps, as I have done. The experts may scorn my methods, but they meet the criteria I have laid down. The program works and it does just what I want. It operates quickly enough for the output to be shown both on the VDU and the printer at the fastest they will operate. No doubt it could be made more elegant, but time is short and there are, no doubt, many other tasks to perform.

```
• 70 A=B+C(J)
• 77 R(J)=A/P
• 78 IFP$<>"ALL"THEN81
• 79 J=J+1
• 80 NEXT
• 81 PRINTCHR$(147)
• 82 PRINT" LOAN SCHEME"
• 83 PRINT
• 84 Z=FNA(S)
• 85 GOSUB10000
• 86 PRINT" COST OF GOODS";TAB(30-LEN(Z$));Z$
• 87 PRINT
• 88 Z=FNA(D)
• 89 GOSUB10000
• 90 PRINT" DEPOSIT";TAB(30-LEN(Z$));Z$
• 91 PRINT
• 95 J=1
• 96 IFP$<>"ALL"THEN98
• 97 FORP=12T036STEP6
• 98 Z=FNA(R(J))
• 99 GOSUB10000
• 100 PRINTP ;"MONTHLY PAYMENTS OF";TAB(30-LEN(Z$));Z$
• 101 PRINT
• 102 IFP$<>"ALL"THEN110
• 103 J=J+1
• 104 NEXT
• 110 PRINT"DO YOU REQUIRE PRINTED RESULT ?"
• 120 PRINT"IF YOUR ANSWER IS YES, THEN SWITCH"
• 130 PRINT"THE TELETYPE ON AND LOAD PAPER"
• 140 PRINT"PRESS DATA BUTTON ON TELETYPE AND"
• 150 PRINT"TYPE 1 ON PET KEYBOARD"
• 160 PRINT"OTHERWISE TYPE 2"
• 170 INPUTH
• 180 IFH<>1THEN9999
• 190 OPEN1,4
• 200 PRINT#1,"LOAN SCHEME QUOTATION BY C.AXSON & SONS"
• 210 PRINT#1
• 220 Z=FNA(S)
• 230 GOSUB10000
• 240 PRINT#1," COST OF GOODS";TAB(37-LEN(Z$));Z$
• 250 PRINT#1
• 260 Z=FNA(D)
• 270 GOSUB10000
• 280 PRINT#1," DEPOSIT";TAB(43-LEN(Z$));Z$
• 290 PRINT#1
• 300 J=1
• 310 IFP$<>"ALL"THEN 330
• 320 FORP=12T036STEP6
• 330 Z=FNA(R(J))
• 340 GOSUB10000
• 350 PRINT#1,P ;"MONTHLY PAYMENTS OF";TAB(28-LEN(Z$));Z$;
• 360 Z=FNA(C(J))
• 370 GOSUB10000
• 380 PRINT#1,TAB(10);"INCLUDING CHARGES OF";Z$
• 390 PRINT#1
• 400 IFP$<>"ALL"THEN9999
• 410 J=J+1
• 420 NEXT
9999 END
• 10000 Z$=STR$(Z)
• 10010 L=LEN(Z$)-2
• 10020 IFL=0THEN10060
• 10030 IFMID$(Z$,L,1)=". "THEN10090
• 10040 L=L+1
• 10050 IFMID$(Z$,L,1)=". "THEN10080
• 10060 Z$=Z$+".00"
• 10070 GOTO10090
• 10080 Z$=Z$+"0"
• 10090 RETURN
```

ON THE LINE

David Hebditch draws the series to a close with an update of the new Personal Computer Network.



"End of transmission"

Since this column started some fifteen months ago, we have provided a fairly complete teach-in on the hardware and software technology of data communications on micro systems. We've also explored the increasing importance of telecommunications in an era of energy crisis; move the information to people rather than people to the information.

In that context, it's not "niggling" to keep pressure on the Post Office to improve their quality of service; it's almost a public duty. Every time I get twinges of guilt something happens to banish them (and if anyone from the PO is reading this, perhaps they could explain why there is still no telephone in my new house on the first anniversary of the order being placed).

The stand at the PCW show last year attracted a lot of interest. A pair of

PETS were used by many visitors to swap messages with the PETALECT stand. The link from my Apple to Rair Timesharing's PDP-11 worked well . . . we also linked successfully to a DEC System 10, an IBM 370/168 VM System, a CDC something-or-other and (wait for it) an Atlas! I hasten to add that these calls were established by authorized users.

The Personal Computer Network was launched at the show and we have since signed up over sixty participants. This list will, I believe, rise to well over a hundred before the end of the year. Even if you have no communications hardware yet, you can still participate in the technical discussions by completing the form in the November PCW, or by writing to me care of the Editor.

Even when we have published the directory of members, there would still seem to be a practical problem in the administration of the network. It's occurred to me that a lot of the time, money and patience can be wasted by working through the list to find someone ready to go "on line". What we need is some kind of computer "clearing house" which you can connect to and enter your times of availability and to find out who else is looking for a contact.

Accordingly, I have started discussions with a couple of commercial time-

sharing companies to see if they would be prepared to provide such a facility. In addition to providing a central directory source, we could also implement an extensive range of other goodies. Here are some of them . . .

An online, frequently updated *bulletin* could be used instead of the traditional newsletter, to keep members in touch with development. A mailbox or *message-switching* program would enable electronic mail experiments to be carried out. *Tele-conferencing* techniques could be employed as a means of developing new concepts and practices in such areas as high-level protocols. A series of *communications test programs* can aid the development of special hardware and software at the user site.

The availability of high capacity disc units with the time-sharing service could provide a low-cost means of storing bulk data. Some of the prices I have seen quoted suggest that this arrangement may work out to be cheaper than diskettes for many micro users.

Obviously the existing software library could be made available (for running on the mainframe) but we could also usefully experiment with the *distribution of programs* written in basic BASIC.

And last, but certainly not least, it should be possible to use the big com-

continued on Page 101

GATE MICROSYSTEMS LIMITED



Scotland's Complete Microcomputer Service

now supply and support:

HARDWARE:

Apple II Systems and Peripherals
Commodore Business Systems
A wide range of VDUs, printers, etc.

SOFTWARE:

Incomplete Records Accounting
Sales Ledger
Purchase Ledger
Nominal Ledger
Stock Control
Payroll
Word Processing
Database

Software can be tailored to your requirements or written completely to your specifications.

Our service is comprehensive, ranging from advice on system selection through installation and implementation, to operator training and comprehensive Hardware and Software maintenance.

You don't have to take our word for it.

Call us and arrange a demonstration.

GATE MICROSYSTEMS LTD.,
THE NETHERGATE CENTRE,
66 NETHERGATE,
DUNDEE.
TEL: (0382) 28194.

compare the Compucolor II....

Apple II

Basic 16K computer £819
 Disc £398
 Colour Display (TV) £239
 (with attendant limited definition)
 RS233 for printers etc. £110
 Modern Interface £ N/A
 with program controllable
 Baud rates

TOTAL £1566

Compucolor II

£1185
 NIL cost integral
 NIL cost
 Included
 Included

£1185 TOTAL

Included with each machine –
 Assembler
 Text Editor
 10 part Basic Tutorial
 Disc for matter
 Sampler Disc
 plus lots more!

Also available –
 A full range of business, scientific
 and personal software.

Also included is 18K of ROM
 containing 12K Microsoft Type
 BASIC with 6K Graphics Extensions
 and DOS, also 4K additional
 Dedicated Screen RAM

Get Sharp, crisp, colour graphics
 all in one neat economical package.

Call us now on 01-580 8841

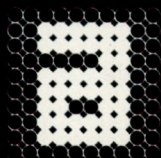

Abacus
 Computers
 Limited

62, New Cavendish Street, London W1M 7LD

50,000TH

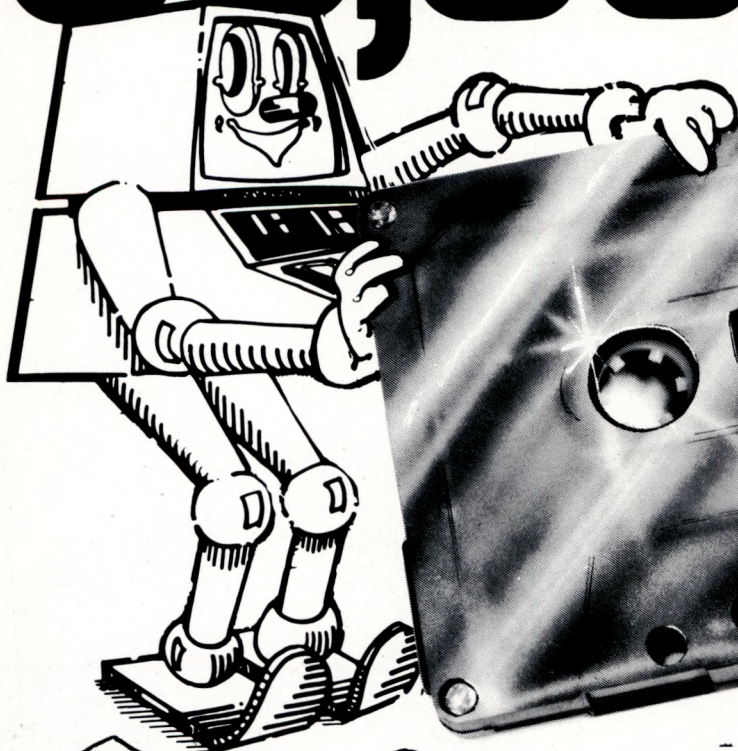

The Petsoft Gold Cassette . . .
... presented to Oliver Bulmer,
author of "Mailing List"

60% OFF!

We celebrated by slashing
Ledger systems prices by over 60%:

SALES LEDGER	£95
PURCHASE LEDGER	£95

Developed by ACT, Britain's leading computing group, to run on a 32K PET with Anadex or Datac BD80 printers. Commodore Disk versions available price £115.

These systems provide full facilities for ledger maintenance, preparation of lists of outstanding balances, printing of statements and remittance advices. Full audit trail. Send for details.



Disk Payroll £50 for up to 200 employees
Disk Stock Control £50 handling 2,500
 stock items (Petsoft/CompuThink Disk) or
 400 stock items (Commodore Disk)

AND

Mailing List £15	VAT Pack £17.50	Microchess £14
Word Processor £25	Invoicing £20	Super Startrek £8
PET BASIC Tutorial £15	Forth £30	Eliza Doctor £8
Assembler/Editor £25	Statistics £7	Backgammon 8

Prices exclude VAT. Credit card orders accepted by telephone. All programs available through your local PET dealer or direct from:

All prices correct at the time of going to Press.
PET is the trademark of Commodore

ACT Petsoft

Radclyffe House, 66-68 Hagley Road, Edgbaston, Birmingham B16 8PF. Telephone: 021-455 8585 Telex: 339396



Please
rush me your latest catalogue
of over 170 PET programs.

My name is _____

I live at _____

Postcode _____

I have a new/old ROM PET

I have NO PET



COMPUTER GAMES



PRUNING BIG TREES

Here in part three of the series, David Levy introduces a minimax refinement known as the alpha-beta algorithm.

Games with big trees

Last month we discussed the use of the minimax method to search game trees, using noughts and crosses as our example. This is a game with sufficient symmetry to reduce the number of essentially different moves at the start to three: the centre, a corner and the middle of an edge. At the second ply there are a total of 12 essentially different positions, so with only seven spaces then remaining there will be an upper bound of $12 \times 7!$ on the total number of terminal positions in the whole of the game tree. In practice the total will be somewhat less than this figure, since a number of paths will lead to a win for one side or the other, or a draw (i.e. a position in which every row, column and diagonal has at least one "O" and one "X" in it), before all nine elements of the 3×3 array have been filled. In order to play a perfect game of noughts and crosses with the crudest of evaluation functions, we could search the game tree exhaustively, using a score of +1 for a variation won by the program, -1 for a variation won by the opponent, and 0 for a draw.

Most interesting two-person games have much larger trees than this: in chess there are roughly one million terminal positions in an average 4-ply search, in Go the figure would be ten thousand million for a 4-ply search at the start of the game. How can we cope with such gigantic combinatorial growth in our game trees? The answer lies in a refinement of the minimax method known as the alpha-beta algorithm.

The alpha-beta algorithm

The alpha-beta algorithm owes its power to the argument that if a player can choose from a number of moves, once he finds one move which serves his purpose he need not examine the remainder of the moves in that group. Let us look at a simple two-person game tree to illustrate this point (Fig. 1).

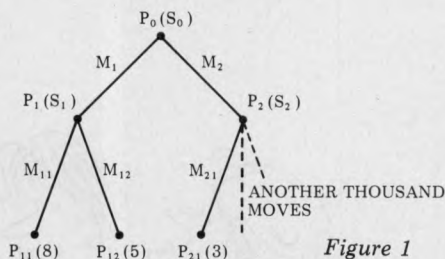

Figure 1

We shall assume that a program searches the tree from left to right, and that the evaluation function assigns scores of 8, 5 and 3 respectively to the terminal nodes P_{11} , P_{12} and P_{21} . If the program is to move from position P_0 , it first considers move m_1 and then tries to decide what its opponent will do from position P_1 . The opponent may choose between scores of 8 and 5, and since we have adopted the convention that the opponent's target is a low score, the opponent will choose position P_{12} with a score of 5.

The program now knows that if it chooses m_1 , its opponent can prevent

it from achieving a score of more than 5. This value of 5 is therefore the value of position P_1 , assuming correct play by the opponent, and so the value 5 is assigned to S_1 . We call this process of assigning values as the program backtracks up the tree "backing-up".

The score at S_1 is now backed up to S_0 and the program then considers position P_2 , to determine whether it will prefer to play move m_1 or m_2 . It sees that from position P_2 its opponent can, if he wishes, move to P_{21} for a score of 3, and since 3 is better than 5 from the opponent's point of view, the program will wish to deny its opponent this option and it will not, therefore, choose move m_2 . It is completely irrelevant what the scores are for the thousand of unexamined brother nodes, P_{22} , P_{23} , . . . P_{21001} , because the move m_{21} is already known to refute m_2 . Thus the program has determined that m_1 is better than m_2 , even though it has examined only 3 of the 1,002 terminal nodes of the tree!

Of course this particular example has been specifically designed to sell you the alpha-beta algorithm, and most game trees do not allow us to get away so lightly, but the savings achieved with this algorithm are certainly substantial enough to make alpha-beta an almost essential segment in any program that searches two person-game trees. The algorithm always chooses the same move that would be selected by the minimax algorithm, but usually in a fraction of the time.

Since alpha-beta is so very important in game playing, I make no apologies

Figure 2

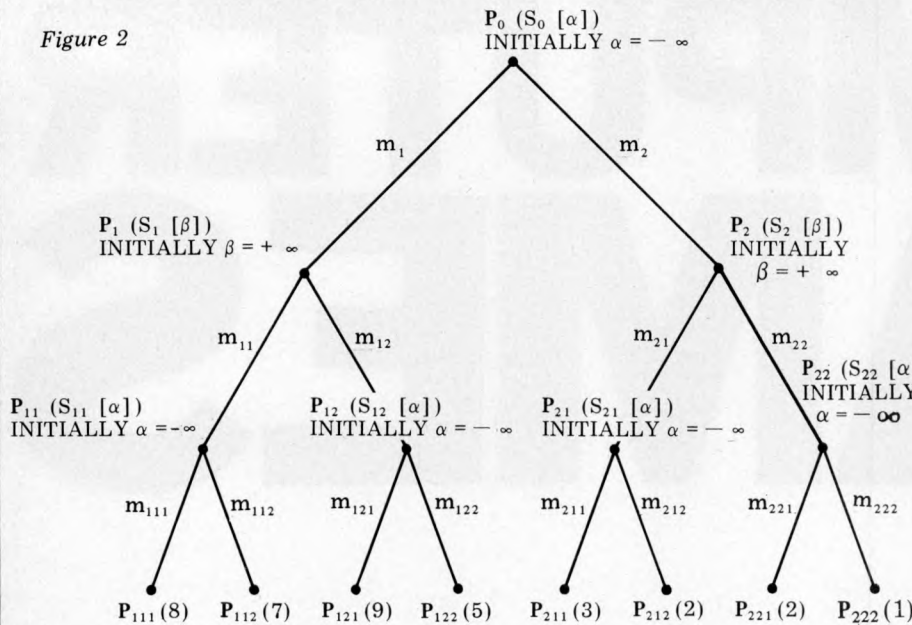

for including another, more complex example (Fig. 2). This will show how the method works for a 3-ply tree and will illustrate why it has been given its strange name.

Initially, all non-terminal nodes at even ply are assigned the value $-\infty$ (α). All non-terminal nodes at odd ply are assigned the value $+\infty$ (β). As usual it is the program's turn to move from the root position P_0 , and the program is trying to maximize the value of α . The opponent moves from positions P_1 and P_2 , trying to minimize the value of β . The program moves from the positions at ply-2 (P_{11} , P_{12} , P_{21} and P_{22}), trying to maximize α .

The tree search now proceeds as follows:

1 Examine P_{111} . The score of 8 is greater than $-\infty$ so α at S_{11} is set to 8. This score is then compared with β at S_1 and found to be less than $+\infty$, so this value of β is also set to 8. In order to decide whether the program might be willing to play m_1 , this score of 8 at S_1 is compared with $-\infty$ at S_0 and found to be greater, so α at S_0 is set to 8.

2 Examine P_{112} . The score of 7 is less than α at S_{11} , which is now 8, and since it is intended to maximize α , the value of α at S_{11} is not adjusted, and therefore the value of β at S_1 and that of α at S_0 also remain unchanged.

3 Examine P_{121} . The score of 9 is greater than $-\infty$, so α at S_{12} is set to 9. This score is then compared with β at S_1 and found to be greater, and since it is intended to minimize β the program can reject move m_{12} , knowing that its opponent can do better with move m_{11} .

4 The left hand side of the tree has now been examined and the search proceeds to the comparison of the best score achieved so far (8) with whatever can be reached, assuming best play by both sides, if the program should choose m_2 . This part of the search commences with an examination of P_{211} , which is found to have a score of 3. This is compared with α at S_{21} and found to be greater, and since it is intended to

maximize α the program will set this value of α to 3.

5 Examine P_{212} . The score of 2 is less than 3, so α at S_{21} (currently 3) is left unchanged, since it is intended to maximize α . This score of 3 is then compared with β at S_2 , found to be lower, and since it is intended to minimize β this value of β at S_2 is set to 3. Finally this value of 3 is compared with α at S_0 (currently 8) and found to be lower. Since it is intended to maximize α , the program already knows that m_2 is inferior to m_1 , because playing m_2 is not consistent with maximizing α .

The search is now over and it can be seen that only five of the eight terminal nodes needed to be examined. If you

wish to verify the validity of this process by practical means, try assigning different sets of values to positions P_{122} , P_{221} and P_{222} , and you will always find that the program prefers move m_1 to move m_2 .

How powerful is the alpha-beta algorithm?

During the past few years there has been considerable research into the question of just how big are the savings achieved using this algorithm rather than simple minimax. A full discussion of the theoretical and practical results of this research is well beyond the scope of this series, but the studious reader will find this work well documented in the bibliographic references found at the conclusion of this article. What follows is a summary of the most important results, and a brief discussion of their significance.

Monroe Newborn has investigated the power of the alpha-beta algorithm when searching game trees in which the moves within any group are examined in a random order. Table 1 shows, for various branching factors (b), the number of terminal nodes which we would expect a program to examine, using alpha-beta, in searches of 2 and 3-ply.

It will be seen that as the branching factor increases, so the proportion of nodes that can be ignored thanks to the alpha-beta algorithm also increases. And as the depth of search increases the effect of the algorithm is again increased. So the bigger the tree becomes, the greater will be the savings using the alpha-beta method.

The savings become even more dramatic when the branches of the

Table 1

b	2-ply search		3-ply search	
	total terminal nodes	expectation	total terminal nodes	expectation
2	4	3.67	8	6.84
4	16	12.14	64	40.11
8	64	38.65	512	220.37
16	256	122.11	4096	1214.45



"Are you the computer gentleman who asked for two parallel ports?"

tree are examined in an intelligent order. In general it is true to say that within any group of moves the best one should be examined first, so that if the best one is not good enough we need not waste time in examining the second best, third best and inferior moves. If the tree is searched in such a way that the moves are examined in their optimal order, then the number of terminal nodes examined will be approximately $2 \times \sqrt{N}$, where N is the total number of terminal nodes on the tree. Thus, for a game of chess in which the branching factor is typically 36, the number of terminal nodes on the tree is 36^4 for a 4-ply tree. Yet by using the alpha-beta algorithm, if the tree is optimally ordered we need examine only 2×36^2 terminal nodes before we find the best move from the root of the tree, a saving of well over 99% when compared with the simple minimax method.

Taking the figures from Newborn's results quoted above, we can compare the expected number of nodes examined with random ordering and the number of nodes examined with optimal ordering (Table 2).

I hope that the reader is now convinced that for all two-person game trees, except the smallest of the small, alpha-beta is a must. The most important implication of these results is that if it is at all possible, you should generate and/or examine the moves within any group or family in such a way as to take maximum advantage of the savings that can be achieved, and this means ordering the search in some way. We shall discuss various techniques for speeding up the alpha-beta search in our next month's article, but one obvious method can be mentioned here. First, generate all the moves at the root of the tree, m_1, m_2, \dots etc., and evaluate the resulting positions with the evaluation function. Sort the moves so that the move with the highest score will be examined first, then the move with the next highest, and so on.

Next look at the first position on the list and generate its successor positions. These are assigned scores using the evaluation function and they are then sorted, this time with the lowest scored position coming at the top of the list and the highest scored position at the

Table 2 b	2-ply search		3-ply search	
	random	optimal*	random	optimal*
2	3.67	3	6.84	5.66
4	12.14	7	40.11	15
8	38.65	15	220.37	44.248
16	122.11	31	1214.45	127

*The approximation $2 \times \sqrt{N}$ referred to above is made slightly more accurate by subtracting 1. This is not important for very large trees

but it has been done here for the sake of accuracy.

bottom. (This is because the program's opponent is trying to minimize the score.)

This process is repeated all the way down the tree, except for the terminal nodes, which are not sorted. Now, when searching the tree with the alpha-beta algorithm, the tree will be found to be much nearer an optimally sorted tree than if this process had not been applied. One disadvantage of this method, however, is that it requires us to keep in memory all the successor nodes to each node on the principal variation, apart from the terminal nodes. So in a search of a chess tree, with 36 moves at each node, this method would require us to keep in memory:

- a the root node
- b 36 nodes at each level of look-ahead apart from the terminal node.

In order to combat this problem we might try to find an extremely compact method of representing a position, but if this compactness results in a slowing down of the search process while each position is unravelled or created, much of the effect of the fast alpha-beta algorithm will be lost. Such problems require careful thought and it is often necessary to experiment before the best balance is achieved between representation and optimality of search.

Other useful techniques for examining the moves in a sensible order can often be found by thinking a little about the nature of the game. Let us consider once again the game of noughts and crosses. The elements of the 3×3 array might be numbered as in the following diagram:

```

1  2  3
4  5  6
7  8  9

```

A simple way to generate all the legal

moves from any position is to look at the elements, starting with 1 and working up to 9, and putting any empty space on the move list. But with a basic knowledge of the strategy of the game we can speed up the search process by looking first at element 5, then 1, 3, 7 and 9, and finally at 2, 4, 6 and 8. This method of move generation takes no longer than 1, 2, 3, 4, . . . 9, yet it enables the alpha-beta algorithm to examine the moves in a more sensible order, thereby taking us closer to an optimal search process.

Next month we shall examine a flow-chart for the alpha-beta algorithm and look at further ideas for speeding up the search process.

Task for the month

Write a program to play noughts and crosses, taking advantage of symmetry and employing the alpha-beta algorithm. Search the whole game tree using the primitive evaluation function described above (+1 is a win for the program, -1 a win for the opponent and 0 a draw).

Test the program (a) when the moves are generated in a random order; and (b) when the moves are generated in the order: centre, corners, middle of edges. The results should indicate a useful improvement with ordered search over random search.

Bibliography

- Knuth, D.E., and Moore, R.W.: *An Analysis of Alpha-Beta Pruning*. Artificial Intelligence, vol. 6, pp. 293-326, 1975.
- Newborn, M.M.: *The Efficiency of the Alpha-Beta Search on Trees with Branch-dependent Terminal Node Scores*. Artificial Intelligence, vol. 8, pp. 137-153, 1977.

Interrupt — cont from P66

promising of the new technologies — viewdata — cannot be seen in its true development without recognition of the social fact that it's closely linked not only to television ownership, but also to the telephone. Ask yourself . . . how could viewdata and all that it promises for computer terminals in the home have entered a society which had not already placed a premium on establishing comprehensive telecommunications links.

Further, it's not enough to just recognise that these products — and technologies — are developing in the social context outlined above; in turn we should also ponder the way in which the particular form of television we all know so well has developed in the western world. A moment's thought enables us to see that the TV as we know it was not a technology, simply invented in isolation for later massive

effect.

In important ways, television responded to and was shaped by social trends in society, the most significant of which was the twin growth in industrial society of high geographical mobility alongside the break-up of the extended family and resultant shift to the present nuclear form (mum, dad and the kids living away from relatives and moving house a number of times during their lives).

Television — that small box in the living room — neatly adapted to fit this growing trend of an isolated, yet self-sufficient family type. It was no accident . . . the idea of putting it in a corner of the private home was developed at the cost of quality and versatility of image (compare, for instance, TV to the cinema). This is just one of many examples of recent home technologies that consolidate and encourage our latter day family structure.

I would be the first to concede that space available restricts me to only a simple sketch. I hope, however, I have been able to show that the way to look at microelectronics is not in the manner adopted by most of the mass media, or even the NCC project.

The spectre of technological determinism must be removed . . . the idea that technology is in some way aloof from society. Only by doing this will people recognise that reality is much more complex than the starry-eyed futurologists would have us believe. And equally we must see that, just as the silicon chip is a product of a particular social milieu, so too will be any similar developments in the future. They will not carry the inevitable consequences of an alien technological invasion, rather they will influence the decisions people will make about how our society is, and will in the future, be organised.
Frank Webster, High Wycombe, Bucks.

BOOKFARE

A cold blast of realism . . . Malcolm Peltu takes as his main theme this month, Joseph Weizenbaum's critique of *The Computer Age: A Twenty Year View*.

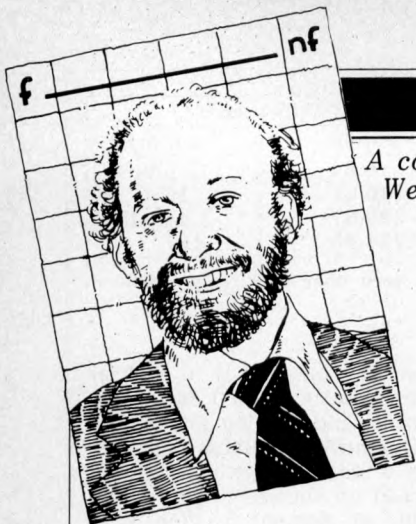

The program kills!

"The computer in its modern form was born from the womb of the military. . . It is probably a fair guess, although no one could possibly know, that a very considerable fraction of computers devoted to a single purpose today are still those dedicated to cheaper, more nearly certain ways to kill ever larger numbers of human beings."

This sour (and somewhat ungrammatical) note characterises the tone of one of the most important critiques of the current wave of euphoria about the potential of micro-inspired information technology, a chapter by Joseph Weizenbaum in what is probably the best book to-date on the approaching "information revolution."

The book is called *The Computer Age: A Twenty Year View* and includes essays from a broad spectrum of American specialists such as microelectronics pioneer and chairman of Intel, Robert Noyce; leading pundit on the emerging "information society", Professor Daniel Bell of Harvard University; and luminaries of what Weizenbaum calls the "artificial intelligentia", — Seymour Papert, Marvin Minsky and Terry Winograd. But it is on Weizenbaum's critique of the book, included as the last chapter, that I wish to concentrate because it poses questions that are seldom even hinted at in the general technological drive.

Weizenbaum is a professor of computer science at the Massachusetts Institute of Technology (MIT), but that does not stop him from questioning the ethical foundations of that subject and even the sometimes false worship paid to MIT (which he calls "the very temple of high science and technology").

In *Computer Power and Human Reason*, which was mentioned in a previous review, Weizenbaum presented a detailed argument about why he fears that computers are unlikely to be employed for the benefit of humanity. He has sharpened these argu-

ments in his critique of *The Computer Age*.

One by one he knocks down the bullish dreams of the technological enthusiasts. On computers in education: "No fix, technological or otherwise, of the American education system that does not recognise that American schools are rapidly becoming America's principal juvenile minimum security prisons can be expected to have socially therapeutic effects. Giving children computers to play with, while not necessarily bad in itself, cannot touch this or any other real problem."

Will the home computer become as pervasive as today's television sets, he asks? The answer is a firm NO. He says that the picture painted of the home of the future with robots cleaning wall-to-wall carpets is one of a "middle class, even an upper-middle-class home" and that typical personal computer applications have little relevance to solving the real problems found in the majority of homes.

He likens the "euphoric dream" of home computer enthusiasts to the belief that radio, TV and satellite technology would expose the mass of children to the beneficial influence of being offered at home the correctly spoken word, great drama, great literature and the most excellent teachers. But in the end, these technologies have merely delivered, according to Weizenbaum, "an occasional gem buried in immense avalanches of the ordure of everything that is most banal and insipid or pathological in our civilisation".

The obsession with computer games, particularly war games, indicates that home computers are about to follow the "same calamitous scripts," says Weizenbaum. He quotes an MIT student who commented while playing computer spacewar that, "We ought to get more points for killing than merely surviving" and says that this could prove to be prophetic in a rather deeper sense.

Weizenbaum's over-riding fear is that people place too high reliance on the accuracy of computer-produced results, although the computer system may be contamina-

ted by a "broad spectrum of inadequate and inaccurate" facts, say in economic models. During the Vietnam war, for example, an Air Force computer was programmed to alter all the coordinates for bombing missions in Cambodia to make it appear that the bombs were dropped on "legitimate" targets in Vietnam. These false figures

were then transmitted to a Pentagon computer and were accepted as truthful because they were provided by computer.

Weizenbaum uses this incident to pose serious questions about the responsibility of computer scientists for the application of their technology and goes as far as to suggest that the programmer who wrote the systems to



Illustration by Mike Litherand

falsify bombing reports in Vietnam falls into the same moral category as an Adolf Eichman, who was "just obeying orders".

He says that the frequently used arguments about the neutrality of computers and the inability of programs to exploit or correct social deficiencies are an attempt to absolve programs from responsibility for the harm they cause, just as bullets are not responsible for the people they kill. But, he suggests, that does not absolve the technologist "who puts such tools at the disposal of a morally 'deficient' society."

He ends with a number of unanswered questions; questions that are rarely asked but which raise vital issues about the limitations of computing power. For instance: What limits ought people in general and technologists in particular impose on the application of computers? What irresistible forces are our "worship of high technology" bringing into play? And what is the impact of the computer, not only on the economies of the world or on the war potential of nations, but on the self-image of human beings and on human dignity?

Weizenbaum's chapter is only 20 pages long but its partisan plea on behalf of humans against machines is worth more than the reams of outpourings that ushered in the new decade on a wave of technological claptrap. It also provides a magnificent coda to the generally thoughtful, thought-provoking and knowledgeable book.

Although it costs about three times the price, *The Computer Age* is better value than the *Impact of Microprocessors on British Business* (which is the result of a survey funded by the Department of Industry to find out the consensus view of 35 British businessmen, trade unionists and assorted pundits on the effect of micros).

The consensus opinion given most publicity was that "Britain has no choice but to go forward with micro-electronics — or go out of business". That emphasis is not surprising, given that the aim of the study was to help the government's public relations exercise on behalf of the micro. Amongst its more than 200 agreed conclusions the book provides a bland summary of the main issues but it lacks the technical depth and social scope of *The Computer Age*. Surely it's time to go beyond thinking of the micro in terms of profits and to relate the technology to criteria of human and social objectives, as so trenchantly stated by

Weizenbaum.

Business bits

Following in the jetstream of the microcomputer's surge into the small business market is a shoal of plain-English intros to computers, aimed at the much-sought-after business user.

Those books always claim to be jargon-free and to give a practical insight into the realities of business computing. Often, however, they are infested with jargon, Boolean algebra and out-dated technology. And the picture painted of the real world rarely exists beyond the dreams of the systems analysts as immortalised in systems specs that work on paper but nowhere else.

Three recent books avoid these pitfalls while a fourth, *Purchasing Computers* by Edward Sambridge, should be compulsory reading for anyone involved in obtaining a computer.

Two of the new business guides are produced by the same publisher, Input Two-Nine. Although they are both aimed at what appears to be the same type of reader and much of the same ground is covered, they differ in style and scope. The second edition of *Computerisation for the Small Business* is by Ted Cluff, Secretary-General of the Institute of Data Processing Management and provides a brisk and bracing march through the basic landscape of business computing, pointing out all the necessary landmarks but without lingering to savour the details. Each chapter ends with a practical checklist, which is alright as a quick refresher course on the landmarks but is full of too many general often unanswerable questions like "Is there a will in the company to succeed in the operation of installing a computer?"

Journalist Nicholas Enticknap's *The Philips Guide to Business Computers and the Electronic Office* is more of an A to Z guide of the detailed terrain. Despite its commercial sponsorship by Philips, the text avoids any bias, although Philips gets the lion's share of the photographs, including a spread on their equipment for the electronic office.

Enticknap places current computing in its historical context and takes great pains to describe in informal language the nitty gritty of DP life, from operating systems and programming languages to collators, data range checks and acoustic couplers. It's a tougher read than Cluff's crisp words but in the end more rewarding for someone wanting an understanding of the way computers work, as well as how to manage

them.

Although not solely for the business reader, *Personal Computing* by Daniel R. McGlynn provides a good introduction to the potential of these smaller, cheaper systems in professional and small business applications. It covers all the expected ground in terms of scope of personal computer market, technology and applications. What separates it from the over-enthusiasm which mars some books on personal computers is a clear and frequently restated perspective of some of the limitations of personal computers — particularly in software. Unfortunately, as is typical of too many Stateside books, it's totally oriented to the US market and the publishers haven't even attempted to angle it for the UK. This means you are told of computer stores in Birmingham Alabama but not Birmingham England; it has a skimpy list of stores in the rest of England. And its list of "foreign" magazines includes only one UK monthly — Systems International — but none of the personal computing press.

The Sambridge book may not be exactly bedside reading but it is an invaluable desk-side reference, containing a detailed analysis of "model" terms of contracts for computers, with the discussion aimed particularly at the first-time user. It's based on work by the Nationalised Industries Computer Committee and the Institute of Purchasing Supply. By raising questions like agreed standards of performance, the supplier going bankrupt and attachment of equipment, Sambridge gives a good whiff of the realities of computing life, although nobody should think that, merely by following the guidelines, all problems will be sorted out in the hairy customer-supplier ongoing trauma situation. (Note: A bottle of good wine to the first PCW reader to get the above last paragraph published in Private Eye's Ongoing Situations column).

Fables and chips

What is there in common between Franz Kafka, Doris Lessing, Al Einstein, Beatrix Potter, the Book of Creation, E.M. Foster and H.C. Andersen. Answer: very little, except that Leslie George Katz has put together bytes from their works and produced a quirky and enjoyable little book, *Fairy Tales for Computers*.

The aim of the selection is to offer pre-electronic age fairy tales for computers in

tomorrow's computer age to try to show them some of the quaintness of early human antipathy to the precision processing of intelligent computers. The selection is all very tongue-in-cheek and, in some cases, very obscure. For example, *Beatrix Potter's Tailor of Gloucester* is all about the lack of a sufficient quantity of plum-coloured silk twist to finish a jacket. It's included because it pays such high complement to a quantifiable measure! (*If you can understand that, dear reader, you're a better man than I - Ed.*)

The most trenchant piece, in fact a gem, is *The Machine Stops* by E. M. Foster. This is a short story set in an age where a machine (it was written as early as 1928, long before he could name the beast Computer) runs a subterranean world of cocooned, pasty-bodied people — until something goes wrong . . . *The Nature Theatre of Oklahoma* by Franz Kafka is a typically surrealist piece about the day the Theatre advertised a paradise of employment and leisure which could be (and is by the editor) taken as a comment on ideas of the future "Leisure Society".

But *The Nightingale* by Hans Christian Andersen is a clear parable of our times, with a live nightingale at first rejected in favour of a more consistently reliable robot nightingale, but with nature triumphing in the end. All together, an invigorating little book. (Note: another bottle of vino to the first letter opened pointing out the deliberate mistake in this month's Bookfare; the winner must also give the corrected text).

Discussed in this month's Bookfare have been: *The Computer Age: A Twenty-Year View* edited by Michael L Dertouzos and Joel Moses (Massachusetts Institute of Technology Press, London £15.00) *The Impact of Microprocessors on British Business* (National Computing Centre, £5.50); *Purchasing Computers* by Edward Sambridge (Gower Press, £12.50) *Computerisation for the Small Business* by Edward G. Cluff (Input Two-Nine, £4.50) *The Philips Guide to Business Computers and the Electronic Office* by Nicholas Enticknap (Input Two-Nine £3.95 or £4.95 hard-cover) *Personal Computers* by Daniel R McGlynn (John Wiley & Sons, £6.00) *Fairy Tales for Computers* edited by Leslie George Katz (Nonpareil Books, Boston, £3.00 available from Colletts Books, London).

SIMPLE TV/MONITOR CONVERSION

Largely for reasons of cost, many a micro user will make do with an ordinary domestic TV, rather than bear the expense of a purpose built VDU. That means one has to suffer all the usual problems of degradation of image — caused to some considerable extent by a need to use the set's unnecessary demodulation circuitry and the consequent inclusion of an (often cheap and nasty) modulator. Peter Dunkley outlines one way around the problem.

Having chosen to attach a conventional television to the output of your micro, you face some problems. Generally the video is fed, via the r.f. modulator, to the TV's aerial socket. You have the cost and complexity of the modulator and connecting leads, together with the need for some form of power supply.

The degradation in quality (compared to a VDU) can be attributed to one major source. . . the filters in the i.f. and detector systems. Although these filters are essential for the normal functioning of the set in that they avoid sound, colour subcarrier and adjacent channel interference, for VDU purposes, they do limit the resolution of the display. Also the modulator and the tuning of the set can drift; results can degrade still further and continual fine tuning may become necessary.

A solution

Mains television sets nearly always have a live chassis and therefore are difficult to modify for an external video input; at the very least, they will require a bulky isolation transformer.

I decided the answer was to slightly modify a portable 12" mains/battery operated set, but in such a way that it could still function correctly as a television — at the flick of a switch. Therefore, although this exercise involves buying a low price, portable TV, its dual function gives an added bonus. The cost of modification is comparable with that of a modulator and accomplishment of the work should be within the capabilities of anyone who can solder, carry out limited mechanical work and who understands a little about television sets.

The model I used was a Rank Bush Ranger 2 (No. BM 6514 B). It's a 12" and I chose it because a) it's British, b) it's the cheapest I could find (£65-70 inc VAT from Comet) and c) perhaps most importantly, the set already contains an isolation transformer in its

power supply.

Although the instructions I give here will relate specifically to this set, my guess is that most mains/battery portables will prove equally suitable — provided you're able to work out how to apply the same kind of modifications.

A glance at the service sheet and a quick prod with a scope probe showed that simple modification was not possible as virtually any additional wiring

around the video detector resulted in degradation of the TV sound. Also, severe "damage" would have to be done to the printed circuit board and at that stage I didn't know whether the mod was practicable. I therefore designed the additional detector output stage as given in the diagrams (below and right).

The main pcb in the set is well legended on both sides so there should be no problem in following the instructions.

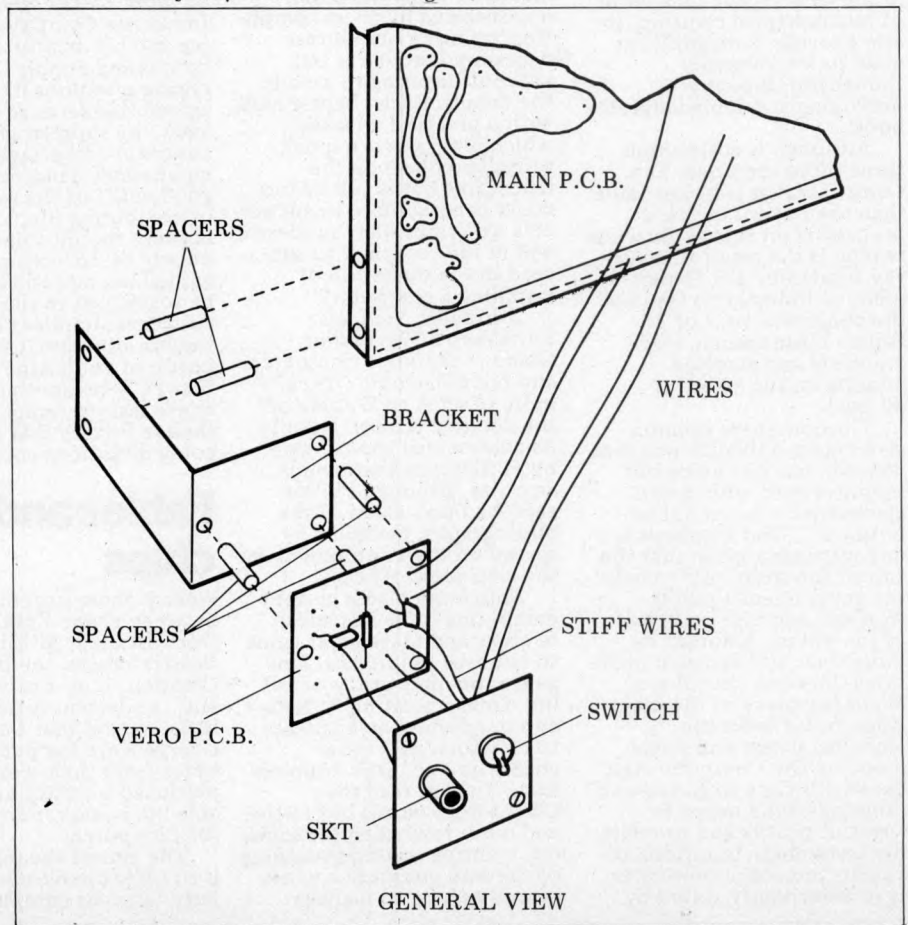

Removing the back of the television

(These instructions come from the relevant Rank service data sheet. . . it's worth having if you can get it).

- 1 Remove the back of the receiver (several screws).
- 2 Slacken the keyhole slot screw at the top left hand side of the cabinet.
- 3 Slacken the pivot screw on the right hand side of the chassis, located by R23.
- 4 Remove the crt base.
- 5 Unclip the battery lead from the retaining clip on the top of the chassis.
- 6 Lift up the left hand side of the chassis until the keyhole slot screw is clear of its slot and the base of the chassis is clear of the retaining lug on the cabinet.
- 7 The chassis may now be swung away from the cabinet.
- 8 To re-assemble, reverse this procedure, ensuring that all the screws are re-tightened and that the crt base is refitted with its leads over the top of the main chassis.

Making the mods

On the main pcb locate contrast pot RV5 and plug 2 pin 14 (bottom edge of pcb). These are joined by a wire (green?) and there's also a grey wire between plug 2 pin 11 and C8; remove both wires neatly.

Locate also the following points; earth, which is the lowest edge of the main pcb, and 11v HT, the pcb track that runs part way round the tube neck hole in the middle of the board. When connecting the 11v HT use the end of R17 furthest from R47. Check these with a test meter before use.

Build the new board as detailed in the diagram. Make up a metal panel and metal bracket as shown and mount bracket, board and panel as shown in the diagrams. Cut a hole in the rear of the cabinet. As there are stiffening ribs inside the cabinet it's easiest to position the hole with reference to the inside and not just blindly mark out on the outside and hack away. Connect up the new panel to the switch and the old pcb. Wires are taken to the rear of the main pcb (the "wrong" side). . . allow a little slack to go round parts of the cabinet back when fitted. Stiff wires are best used for the switch and socket panel so that it supports itself in approximately the right position. After the cabinet back has been refitted, two screws then

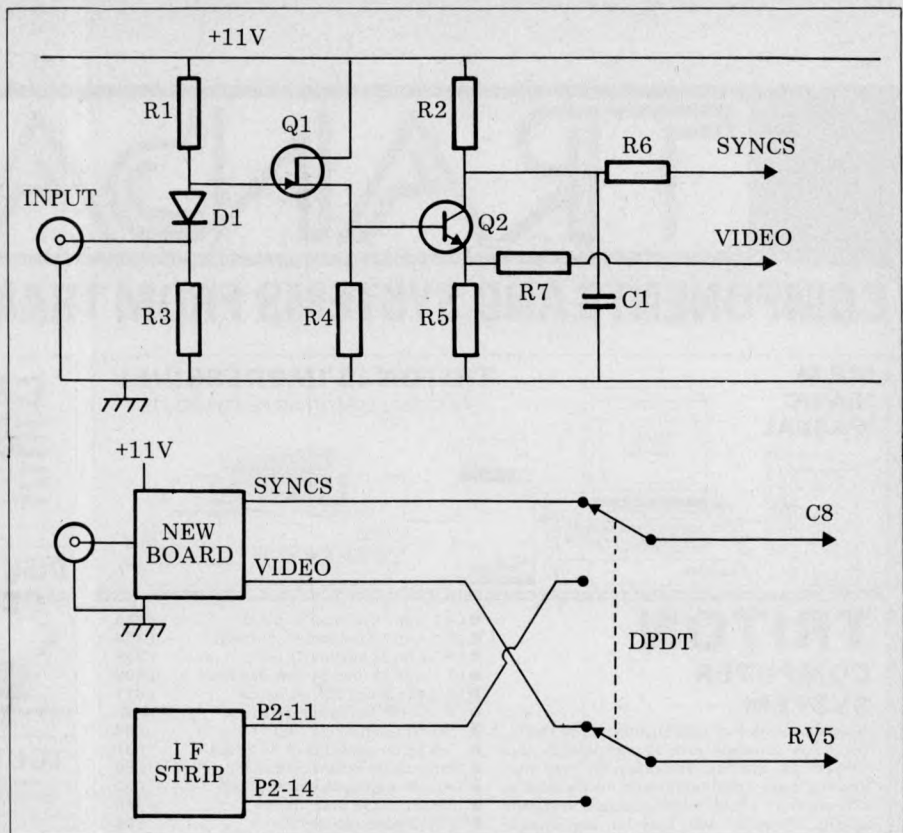

attach this panel to the rear of the cabinet (the diagrams should make this reasonably clear). Note that an additional step will now become necessary in the cabinet back removal instructions, i.e. remove screws holding modification panel in place.

Conclusion

Let me make it quite clear that I have only modified this particular set, and no other. As I pointed out earlier, although there is no reason why similar modification should not be done to other portables, each case would have to be considered individually. Also I made no attempt to build a high quality VDU with a bandwidth of 15-20 MHz; this was not my intention. However, a distinct improvement in display quality results on a 24 line by 40 character display when compared to a modulator fed system.

I don't claim too much originality for the actual design. There are great similarities between "my" circuit and the Rank original. On a video fed test card all the resolution gratings are comfortably visible whereas the same test

card "off air" stops well short of this level of acceptability. I would estimate the resolution of the VDU to be in excess of 6MHz.

I demonstrated my set on a Nascom 1 and found that I could just about read a full line; ideally the line length needed reducing. Tweaking the HT voltage would probably help, but could introduce other problems. A better solution would be a software fix.

A note of warning. . . television sets do contain high voltages and are designed to be totally isolated from outside interference. As this modification violates this principle and the set is not "busy little finger" proof, the new panel should be connected to earth and an earthed mains lead fitted.

With your modified Bush, as a bonus you can still listen to your chosen programme while in VDU mode then at the flick of a switch you can flip over to watch the interesting bits. In addition, for those interested in portability and versatility, the VDU will function happily on 12 volts (drawing 1½ amps) — an ideal solution, perhaps, for the campsite micro enthusiast!

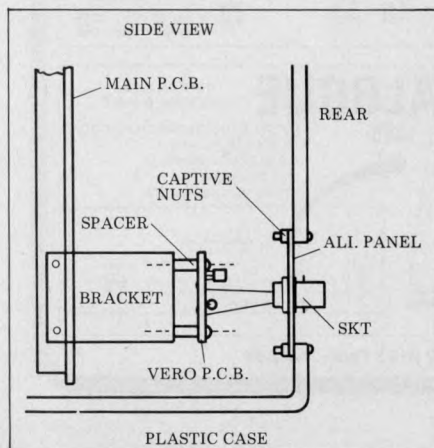

COMPONENT LIST

Resistors

- R1 4K7
- R2 270R
- R3 75R (82R if 75R not available).
- R4 3K3
- R5 270R
- R6 470R
- R7 100R

Capacitor

- C1 1nF

SEMICONDUCTORS

- D1 1N916 or similar
- Q1 2N3819
- Q2 BC172B (BC109C would do)

MISC

- BNC socket 75ohm. (e.g. Radiospares 455-680)
- Double pole Change-Over switch (e.g. Radiospares 316-715)
- Small piece of 0.1 inch Veroboard
- Assorted Metalwork, spacers, nuts, bolts etc as required

TRANSAM

COMPONENTS AND SYSTEMS FROM TRANSAM COMPUTERS

- CP/M
- BASIC
- PASCAL

TRITON IS IMPRESSIVE!
PRACTICAL COMPUTING REVIEW DEC. 79.

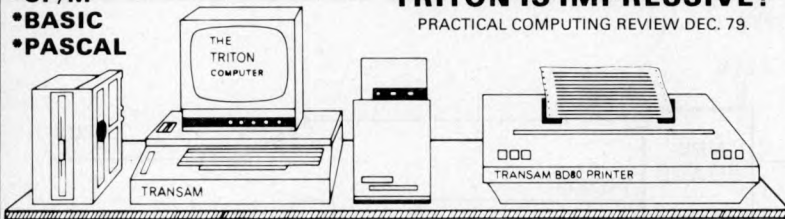

TRITON COMPUTER SYSTEM.

Designed for ease of construction and flexibility. Kits come complete and all components and software are available separately. UK designed and supported. Fully documented hardware and software and a totally flexible approach to system building. Powerful and easy to use system monitors - a range of languages available. Firmware is Eprom based and upgrading from one level to the next is easy.

- L4.1 with 1k monitor 2k basic £286
- L5.1 with 1.5k monitor 2.5k basic £294
- L6.1 with 2k monitor 7k basic £399
- L7.1 with 2k mon 8k extended basic £409
- L8.1 4k ed/mon 20k res pascal £611
- L9.1 CP/M disc based system P.O.A.
- 8k ram card kit (2114L) £97
- 8k Eprom cards (EXCL 8x2708) £31
- Motherboard expansion 8 slot £50
- Trap-res asm/edit etc (8x2708) £80
- Transam BD80 Bi-dir printer £595
- TVM10 video monitor 9" £79
- Eprom prog (2708) kit £29.50

SEND FOR OUR CATALOGUE FOR FULL DETAILS OF TRITON FEATURES!

FULL RANGE OF MICRO SUPPORT CHIPS - IN STOCK

SN74LS00N	22	SN74LS54N	21	SN74LS138N	95	SN74LS195AN	85	SN74LS325N	255	SUPPORT	2.20	RAMS	2.32
SN74LS01N	22	SN74LS55N	21	SN74LS139N	95	SN74LS196N	120	SN74LS326N	255	8212	2.80	2101	2.32
SN74LS02N	26	SN74LS63N	150	SN74LS145N	120	SN74LS197N	120	SN74LS327N	255	8216	2.80	2102L4	1.20
SN74LS03N	26	SN74LS73N	35	SN74LS148N	175	SN74LS221N	125	SN74LS352N	135	8224	2.80	2111	2.32
SN74LS04N	26	SN74LS74N	40	SN74LS151N	85	SN74LS240N	220	SN74LS353N	150	3853(F8)	10.00	2112	2.46
SN74LS05N	26	SN74LS75N	46	SN74LS153N	60	SN74LS241N	190	SN74LS355N	65	8228	4.20	6810	4.00
SN74LS08N	20	SN74LS76N	35	SN74LS154N	160	SN74LS242N	190	SN74LS366N	65	8726A	1.75	8154	11.50
SN74LS09N	22	SN74LS78N	35	SN74LS155N	125	SN74LS243N	195	SN74LS367N	65	8728	1.90	2114L-450	5.50
SN74LS10N	18	SN74LS83AN	115	SN74LS156N	125	SN74LS244N	210	SN74LS368N	65	8522	8.75	2114L-250	7.80
SN74LS11N	26	SN74LS85N	110	SN74LS157N	60	SN74LS245N	360	SN74LS373N	175	8251	5.00	74C920	11.00
SN74LS12N	25	SN74LS86N	40	SN74LS158N	99	SN74LS247N	125	SN74LS374N	170	8253	11.00	74C921	11.00
SN74LS13N	55	SN74LS90N	65	SN74LS160N	115	SN74LS248N	195	SN74LS375N	72	8255	5.00	74C929	11.00
SN74LS14N	69	SN74LS91N	99	SN74LS161N	115	SN74LS249N	130	SN74LS377N	175	8257	£11.00	4027	5.00
SN74LS15N	25	SN74LS92N	90	SN74LS162N	115	SN74LS251N	145	SN74LS378N	132	8259	12.50	4044	7.00
SN74LS20N	20	SN74LS938N	65	SN74LS163N	90	SN74LS253N	125	SN74LS379N	140	8155	12.50	4045	7.00
SN74LS21N	26	SN74LS95AN	120	SN74LS164N	150	SN74LS257N	140	SN74LS381N	385	8402	5.00	4060	7.00
SN74LS22N	26	SN74LS96N	175	SN74LS165N	170	SN74LS258N	95	SN74LS386N	67	8621P	4.50	2107	7.80
SN74LS26N	29	SN74LS107N	39	SN74LS166N	175	SN74LS259N	145	SN74LS390N	198	8850P	4.80	4116(58 for 01.00)	8.00
SN74LS27N	35	SN74LS109N	39	SN74LS168N	195	SN74LS260N	39	SN74LS393N	150	8852P	5.50	4118	20.00
SN74LS28N	35	SN74LS112N	39	SN74LS169N	195	SN74LS261N	350	SN74LS395N	180	AY.5.2376	11.50	280P10	8.00
SN74LS30N	25	SN74LS113N	44	SN74LS170N	250	SN74LS266N	39	SN74LS396N	170	MC14411	12.00	280CTC	8.00
SN74LS32N	27	SN74LS114N	44	SN74LS173N	220	SN74LS273N	85	SN74LS398N	275	MS7109	12.43	280AP10	9.50
SN74LS33N	39	SN74LS122N	79	SN74LS174N	115	SN74LS279N	79	SN74LS399N	180	MS7160	10.00	280ACTC	9.50
SN74LS37N	29	SN74LS123N	90	SN74LS175N	105	SN74LS280N	175	SN74LS424N	450	MS7161	10.00	EPROMS	5.00
SN74LS38N	29	SN74LS124N	150	SN74LS181N	275	SN74LS283N	180	SN74LS445N	125	TM6011	5.00	1702	5.00
SN74LS40N	25	SN74LS125N	65	SN74LS190N	175	SN74LS290N	180	SN74LS447N	125	81LS95	1.80	5204	5.00
SN74LS42N	79	SN74LS126N	65	SN74LS191N	175	SN74LS293N	180	SN74LS490N	195	81LS96	1.80	2708	8.00
SN74LS47N	95	SN74LS132N	75	SN74LS192N	145	SN74LS295AN	220	SN74LS568N	95	81LS97	1.80	2516	25.00
SN74LS48N	95	SN74LS133N	39	SN74LS193N	175	SN74LS298N	220	SN74LS569N	95	81LS98	1.80	2532	50.00
SN74LS49N	108	SN74LS136N	40	SN74LS194AN	189	SN74LS324N	180	SN74LS670N	270				

CP/M AVAILABLE NOW FOR TRITON

Disc operating system complete with text editor, assembler, debugger, system utilities and complete file management. Makes Triton fully CP/M compatible and able to run CP/M based software. Triton will support up to four 5 1/4" or 8" drives single or double density full CP/M software user group facilities available. SAE for details.

DISK DRIVES & POWER SUPPLIES

SHUGART



SA400 5 1/4" drive	£205.00
SA800 8" drive	£380.00
Power one quality power supplies	£33.00
CP249 1x5 1/4" PSU	£60.00
CP323 2x5 1/4" PSU	£56.00
CP205 1x8" PSU	£76.00
CP206 2x8" PSU	£76.00

TCL PASCAL CP/M compatible

A standard Pascal compiler available on a resident (20k) Eprom based configuration* or available to run under CP/M on 8" disc plus documentation. CP/M version £90 - P.O.A.

DIL PLUG SOCKETS & SWITCHES

W.WRAP SKTS	OIL SKTS	DIL PLUGS	DIL SWITCHES
8DIL 0.20	14DIL 0.14*	16DIL 0.60	4DIL 1.20
14DIL 0.35	14DIL 0.15	16DIL 0.65	7DIL 1.75
16DIL 0.42	16DIL 0.17	SCOTCHFLEX	8DIL 1.80
18DIL 0.60	18DIL 0.24	14DIL 1.30	16w ZIF* 4.95
24DIL 0.52	20DIL 0.27	18DIL 1.50	24w ZIF* 6.20
28DIL 0.74	24DIL 0.30	24DIL 2.80	
40DIL 0.95	28DIL 0.36	48DIL 0.50	

ZERO INSERTION FORCE

COMPUCOLOR II - FULL COLOUR

- 13" 8 colour crt display
- Built in 5 1/4" disk
- 16k extended basic in rom
- 71 key keyboard - detached
- R5232 - 50 pin bus
- 8k user RAM - fully expandable



SPECIAL GRAPHICS PACKAGE
£985 Plus VAT

S100 DISC CONTROLLER £195 Plus VAT

As used on Triton. Fully built will drive 8x8" or 8x5 1/4" drives. Single or double density. Works with all Shugart compatible drives. Uses the 1791 chip on board crystal - CPU independent

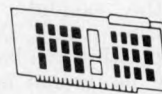

DPS.1 MAINFRAME - PASCAL SYSTEM

S100 to IEEE spec

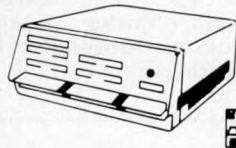

ITHACA

PASCAL/Z build your own Pascal Micro Development system. IEEE - S100 bus system using DPS1 mainframe. Supports K2, ASSEMBLE/Z and PASCAL/Z on 8" disc

S100 BOARDS

8K Static RAM board (450ns)	£123.75
8K Static RAM board (250ns)	£146.25
Z80 cpu board (2MHz)	£131.25
Z80 cpu board (4MHz)	£153.75
2708/2716 EPROM board	£63.75
Prototype board (bare board)	
Video display board (64x16, 128U/L Ascii)	£108.75
Disc controller board	£131.25
K2 disc operating system	£56.25
ASSEMBLE/Z Macro Assm	£37.50
PASCAL/Z compiler	£131.25

WE STOCK THE FULL RANGE OF S100 CARDS AND ACCESSORIES

VISIT OUR SHOWROOM

WE ALSO STOCK: - A comprehensive range of books-magazines. VERO products including S100 and Eurocard and Wire Wrap equipment, Weller soldering equipment, Ribbon Cables, tools, tapes, diskettes and connectors.

CRYSTALS	4MHz	2.10	F8 (3850)	9.50
100k	4.43M	1.00	8080A	6.33
200k	5MHz	2.70	6809	24.00
1MHz	6MHz	2.70	280	8.00
1008k	7MHz	2.70	280A	15.00
1843k	7.168M	2.50	8085A	12.95
2MHz	8MHz	2.70	6502	8.00
2457k	10MHz	2.70	SCMP11	10.00
3276k	10.7M	2.70	6802	13.95

ALL PRICES

Exclude VAT & P/P
VAT 15% P. & P. 40p on small orders.
For larger items please Tel.
Telephone credit card orders accepted subject to £5 min.
RAPID MAIL ORDER SERVICE



CATALOGUE

NEW A4 SIZED ONLY 40p & S.A.E.



1980

VISIT OUR SHOWROOM SOON
9.30-5.30 Mon-Fri
1.30-2.30 closed lunch
9.30-5.00 Sat
Thursday half day 1.30

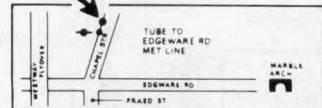

TRANSAM COMPONENTS LTD, 12 CHAPEL STREET, LONDON NW1

Tel: 01-402 8137 Telex: 444898

Dick Pountain ruminates on the pruning of calculator programs, and the randomizing of a certain random number generator.

SAVING STEPS MORE OR LESS RANDOM

Looking back to my promise of a couple of months ago to provide you with more advanced programming information, a problem occurs to me. Namely, what *is* advanced? Since I flatter myself that perhaps ten or more people read this column, what some readers find advanced may be insultingly obvious to others. (I have evidence from correspondence that there are people out there with more programming experience than myself!) Since this problem is essentially insoluble, all I can do is apologise now to any readers to whom the following is old hat.

What I want to do for a change is to follow through the evolution of a part of a program which I recently wrote and which nicely illustrates the logic of program development. (The notation used is for my Casio FX502P, but it can be followed on any calculator with indirect addressing. For the benefit of TI and Hewlett Packard owners: Min means STO, MR means RCL, M+ means SUM and M- means INVSUM, X ↔ M means EXC, and FRAC means INVINT.)

The program is for costing the printing of magazines, and one subroutine is designed to compute what combination of 32, 16 and 24-page sections are required to make up a given size of magazine. This is achieved by dividing the page total by 32 and then performing tests on the fractional remainder to see how many 24s and/or 16s are required. Stated in this way the program structure which immediately suggests itself is:

```

÷ 32 = Min 1 FRAC
- .75 = x ≥ 0 GOTO 1
+ .25 = x ≥ 0 GOTO 2
+ .25 = x ≥ 0 GOTO 3
MR1 INT Min1 0Min2 Min 3
GOTO 4
LBL1 MR1 INT Min1 1Min2 0Min3
GOTO 4
LBL2 MR1 INT Min1 0 Min2 1Min3
GOTO 4
LBL3 MR1 INT -1=Min1 1Min2 Min3
LBL4

```

The numbers of 32s, 24s and 16s required are now in memories 1, 2 and 3. Like most of my first attempts, this is a naive and horribly wasteful approach, but it works, which is better than having something elegant which doesn't!

What measures suggest themselves to

refine it? The three conditional branches are clumsy; perhaps indirect addressing could eliminate them. The idea of "testing" expressed in my first formulation of the problem has proved misleading since the remainder from the division can generate its own branching address as follows:

```

÷ 32 = Min1 FRAC
x 4 = INT Min4 IND GOTO 4

```

The indirect GOTO will cause branching to labels 0,1,2 or 3 in half the number of steps required by the three $x \geq 0$ tests.

The second half of the program is a horrible mess with a rat's nest of GOTOs which would give a structured programmer palpitations, and much duplication of memory instructions. By suitably altering the order of the labels, it should be possible to allow the program to "fall through" these sections rather than jumping in and out, so that few memory instructions need to be duplicated:

```

MR1 INT Min1 0Min2 Min3. . . . .
LBL 1 1M-1Min3
LBL 3 1Min2 GOTO 0
L3L 2 1Min3
LBL 0

```

This has halved the number of memory operations and exterminated a couple of GOTOs and the result is beginning to look almost civilised.

The last steps of pruning and tidying involve making maximum use of the contents of the X-register (display register) at each step. For instance, the MR1 INT Min 1 is unnecessary as M-1 placed after FRAC achieves this effect in one step. Also, the indirect address could be stored in one of the working memories and its value used when appropriate — which also frees a memory register.

```

The end result is:
÷ 32 = Min1 FRAC M-1
x 4 = INT Min2 0Min3
1 IND GOTO 2
LBL1 M-1 Min3
LBL2 X ↔ M3
LBL3 X ↔ M2
LBL0

```

What has been achieved here is a reduction from 62 to 26 program steps, but more important to me is the sense of pleasure in making every step earn its keep and in utilising more powerful in-

structions to do it. The more advanced programmers among you may be able to write economically from the first attempt, but I find for myself that there is virtue in following this evolutionary path from a naive but quick-to-write and logically obvious prototype. The refinement process then becomes more than a mere tidying up of loose ends; rather it is an attack on the structure of the algorithm itself, with the object of making it fit the calculator's way of working rather than one's own.

Calculator corner 2

Finally, as promised, a brief word on the Casio's Random Number Generator. Most owners of this machine will have discovered by now that the distribution of numbers given by using RAN# (or even RAN# RAN# as suggested in the manual) in a program is very poor indeed.

Those who have not verified this may like to run this program:

```

LBL1 AC RAN# x 10 + 1 = INT Min0
IND ISZ GOTO 1.

```

This stores the frequency with which the digits 1-10 are generated in their respective memories 1-10, and over 100 or so trial you may well find *none* of certain digits generated! Typical standard deviations for 1000 trials (mean frequency 100) are between 40 and 80!

Using double RAN# doesn't improve things and often it gets caught in loops of varying size generating the same sequence cyclically.

The answer, provided by Mr. Caulfield of Casio, is as follows:

The random number generator, like others of its kind, requires a "seed", and on the 501/502 the contents of the X-register are taken for this seed. The sequence 1 M+n, MRn RAN# will, by providing a constantly increasing seed, give a good distribution (σ 5.4 on 1000 trials in my case). n represents any memory register, and of course you may be able to find a suitable seed already in your program without dedicating an extra register.

While on the subject, owners of other calculators without random number generators who don't know a good routine will find this sequence gives an excellent distribution:

```

RCLn + π = x^5 = FRAC STO n

```

A seed between 0 and 1 should be stored in memory n before use. The power 5 may be replaced by other numbers; I haven't investigated the effect on distribution except that x^2 which executes rather faster gives a marginally inferior one.

THE MEMORY LINGERS ON ~PART 2

Last September PCW published a design by John Stephenson for a simple SC/MP based PROM programmer. He has now developed an enhancement which enables the copying of selected sections of existing PROMs, thus, for example, allowing you to bypass burnt-in bugs while keying in the correct code.

A SELECTIVE PROM COPIER

Copier hardware

Two additional sockets are required, connected pin-for-pin to their opposite numbers SK1 and SK2 on the Programmer, with the exception of Pins 18 and 20 (PGM and CS). Since these two sockets are only used as ROM, Pin 18 of each is grounded. Both Pin 20s are taken to one side of S3, and the other side of this is connected to Pin 20 on SK2. The lead which ran from SK2 Pin 20 to IC1 Pin 3 is disconnected from SK2 and is run to the wiper of S3.

S3 now forms a Read Master/Read Copy switch, necessary since both Master and Copy occupy the same memory position, 0400 - 07FF.

Programmer

To provide faster copying for 2708s the Monostable period may be reduced to 10ms (nominal) by means of S4, selecting a 2MFD capacitor. This must not be used when programming 2716s, and, with 2708s, preferably not for blocks of data less than 16 bytes long, as data corruption may then occur.

Software

This program can be used for both programming and copying. When loaded with the start and end addresses of the data to be copied from the Master EPROM, (at 0F20, 21, 22, 23) and the start address to which the data is to begin in the copy EPROM, the program sequences through the addresses, reading data from the Master and programming it into the copy. Auto-indexed-addressing is used to allow easy sequencing, and P1 is used to point to the Master source address, with P2 as the copy destination address. The program can be used to insert blocks of data into a copy, corrections for example, by copying up to the bug, programming the fresh data, which has been loaded into RAM, from 0F70 to 0FEF, and then continuing with the copying from the end of the bug.

Operation

Load up with Master and Copy, and apply power (don't be tempted to insert chips with power on!).

Load start address of Master block to 0F20, 21

Load end address of Master block to 0F22, 23

Load start address of copy to 0F24, 25 (Blocks may be any size up to 1K)

Load 0F37 with the number of cycle repeats required, 80H for a 2708 (128 repeats) and 01H for a 2716.

Remember that S2 must be set to select the upper or lower 1K of a 2716 to be programmed.

Set S1 to "Program", S3 to "Read Master", and S4 as appropriate to the block length or EPROM type, and run the program from "START", 0F29.

Notes and comments

The prototype copies ¼K in approximately 7½ minutes. This is not up to the theoretical limit of 30 seconds, but who cares? People who *do* care can reduce the monostable time still further but only by adding complication and at the risk of destroying the PROM!

The multiple switches could be replaced by a multi-pole switch if required, as S1 and S3 can be ganged.

Further, S3 could be implemented with a handful of gates operated by "flag 0" on the SC/MP. It would then be very simple to write a verification program to compare copy and master for errors caused by duff PROMs, etc.

If you can't afford Zero-insertion-force sockets (like me!) shop around for 24 pin gold-plated ones and ease out the contacts with a dressmaking pin. This avoids lots of bent I.C. legs!

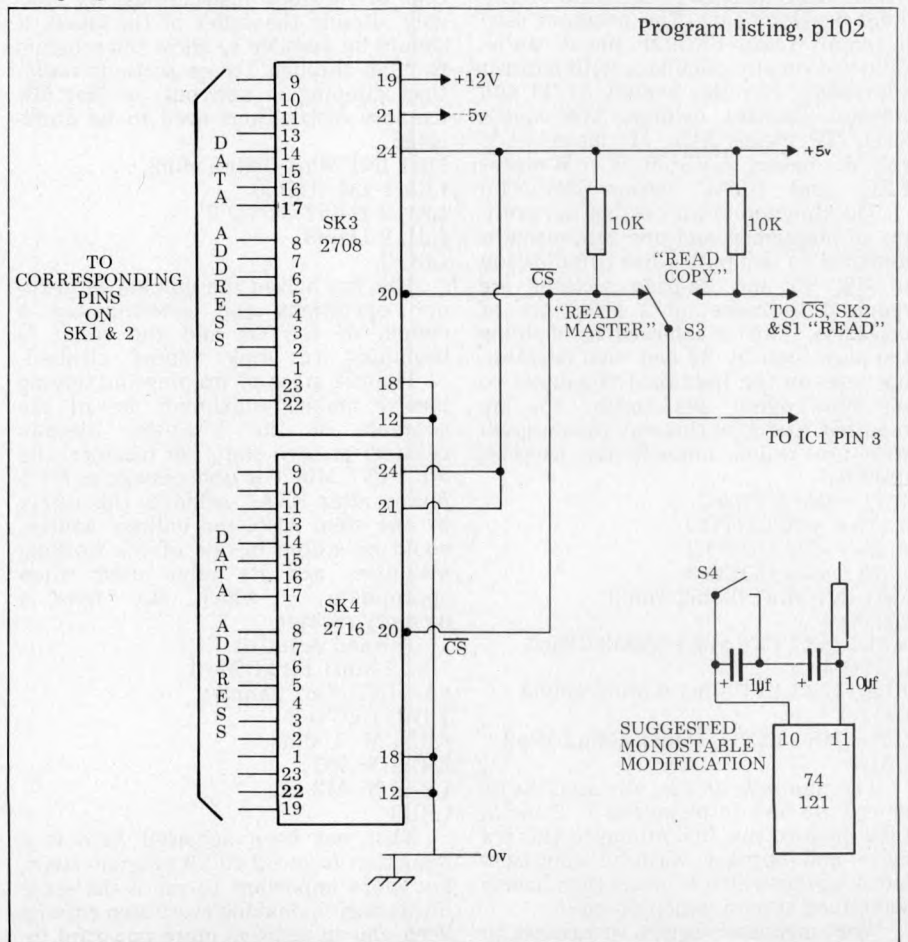

Britain's most up-to-date and comprehensive guide to the selection of microcomputer equipment, compiled for PCW by Richard Olney of Heuristic Consultants.

Machine (Price from)	Main Distributor/s (No. of Dealers)	Hardware	Software	Miscellaneous (Documentation)
ABC 80 (£790)	CCS Microsales: 01-444 7739 (TBA)	16-40K RAM; Z80A; C: 12", 16x40 b&w VDU; 4680 bus; IEEE 488; RS232 port; option — dual 5¼" F/D (160K, own DOS), £895	DOS: BASIC:	Graphics loudspeaker with 128 effects: Viewdata compatible: (S)
ACT 800 (£3,450)	Computhink: 021 455 8585: (50)	48K RAM; 6502; dual 5¼" F/D (800K); 12", 30x64 VDU; RS232 port: 1 P/P	DOS: ExBASIC: A: Dis A: U	High res graphics: also model with dual 8" F/D (2.4MB), £4,450; option — extra dual 5¼" F/D (800K): (B)
Alpha Micro (£8,200)	Alpha Micro (UK) Ltd 01-250 1616 (TBA)	64K-16M RAM; 16 bit; dual 8" F/D (2.4MB); 6 S/P; modular	multi-user O/S: BASIC: M/A: Pascal: U	Expands to 1200 MB, 32 terminal system: (E)
Altos ACS 8000 (£3,398)	Logitek: 02572 66803 (TBA)	64K RAM; Z80; 1K ROM; dual 8" F/D (1MB); 2 RS232; 1 P/P	CP/M: BASIC: Fortran: Cobol: Pascal: M/A	(S&H)
Apple II (£810)	Microsense: 0442 63561 (80+)	16-48K RAM; Z80; 6502; 8 I/O slots; option — single 5¼" F/D (116K), £425	O/S: BASIC: Pascal: games:	280x192 high res graphics: integer BASIC in 6K ROM (S)
Attache (£7,000)	R.H.Thorpe Ltd: 0276 29492, R.J.Spiers Ltd: 0603 416573 (TBA)	48K RAM; 8080; dual 8" F/D (616K); 9", 16x64 b&w VDU; 180 cps printer	ExBASIC: Fortran	(S)
Billings BC-12FD (£4,295)	Mitech: 04862 23131 (TBA)	64K RAM; Z80A; dual 5" F/D (640K); 12", 24x80 b&w VDU	DOS: BASIC: Fortran: Cobol: A	8" F/D (2MB) to replace 5", £6,000; additional dual 8" F/D, £2,750 (S)
CBS Mk 1, 2&3 (Mk1, £4,900; Mk2, £5,900; Mk3, £8,150)	Compelec: 01-636 1392 (N/A)	64K RAM; Z80; dual 8" F/D (1MB); 12", 24x80 VDU; 132 col, 30 cps printer: 2 S/P; 1 P/P	CP/M: BASIC	Mk. 2 with 2MB F/D, £5,900. Can upgrade to Mk.3 — £8,150 (11MB H/D and 4 more S/Ps): Desk mounted: (S&H)
Challenger 1P & C2 (1P, £238; C2, £404)	CTS: 0706 79332; MBM: 01-980 3993; Mutek: 0225 743289; Millbank Computing: 01-549 7262; U-Microcomputers: 0606 853390; Byte Shop: 01-518 1414	4-32K RAM; 6502; C int: RS232 port:	O/S: BASIC: A: ExBASIC	D/A conv: col capability: 8K microsoft BASIC in ROM; option — dual 5¼" F/D (160K), £550; for C2, dual 8" F/D (1.15MB) and 20MB H/D: runs OSI business software on 8" F/D. (S)
Challenger C3 (£2,334)	As above	32-56K RAM; 6502, 6800, Z80; dual 8" F/D (1.15MB); 2-16 S/P	OS65U: BASIC: CP/M: Fortran: Cobol	Also C3B & C3P H/D modules: 74MB for about £10,000: (S&H)
Comma VO3 (£4,200)	Comma: 0277 811131: (N/A)	32K RAM; LSI 11; dual 8" F/D (512K); 4 serial DLU11S ports; modular	RT11 O/S (£750): BASIC: Cobol: Fortran	Many configurations possible: (H)
Compelec Series (£2,400)	Compelec: 01-636 1392: (N/A)	64K RAM; Z80; dual 8" F/D (512K); 2 RS232 ports: 1 P/P	CP/M: A: CBASIC: cobol: Fortran: Pascal	Also with double density F/D (1MB), £2,900; 1K EPROM: (S)
Compucolor II (£998)	Abacus: 01-580 8841: (6)	8-32K RAM; 8086; 13", 32x64 8-colour VDU; single 5¼" F/D (51K); RS232 port	ExBASIC (ROM): A	16K module, £1,078; 34K, £1,209; maintenance and programming manual available: (I)
Compucorp 625 (£6,000)	Compucorp: 01-952 7860: (17)	60K RAM; Z80; dual 5¼" F/D (700K); 9", 16x80 b&w VDU; 40 cps printer: 1 RS232 port	A: BASIC: U	Also 655 model with 320K F/D capability and 12", 20x80 VDU — £4,345 (B)
Comp Workshop System 1 (£1,600)	Comp Workshop: 01-491 7507 (N/A)	32K RAM; dual 5¼" F/D (170K); 9", 16x64 b&w VDU; modular	A: BASIC: Fortran: Flex: Pascal: Pilot	This is an example configuration from a fully compatible modular range: (E)
Cromemco System 2, System 22H, System 3 (£1,995/£4,998/£3,293)	Comart: 0480 215005; Datron: 0742 585490; Microcentre: 031 225 2022 (20)	64K RAM; Z80; dual 5¼" F/D (346K) Sys 2 and 22H... dual 8" F/D (1.24MB) Sys. 3: S/P: P/P	CDOS: BASIC: Cobol: Fortran; Multi-user BASIC: A:	All systems expandable to multi-user (2-7 users), £3,455 £6,400; 11 and 22MB options: also dual 8" F/D (996K) on Sys. 2 and 3: (E)
DAI (£998 48K version)	Data Applications (UK): 0285 2588 (TBA)	12-48K RAM; 8080; C int: 24x60 VDU int; RS232 port: Over 20 industrial ints: 2 C ints	BASIC (ROM): U (ROM)	Up to 255x335 resolution graphics: 3 notes and noise generator: PAL output to TV: games paddle
Digital Microsystem DSC-2 (£5,395)	Modata: 0892 39591 (TBA)	64K RAM; Z80; dual 8" F/D (2.28MB); 4 RS232 ports: EIA port	CP/M: BASIC-E: CBASIC: Cobol Fortran: Pascal	Up to 6 additional F/D units possible: (H)
Durango F-85 (£8,250)	Comp Ancillaries: 07843 6455 (12)	64K RAM; 8085; dual 5¼" F/D (1MB); 9", 16x64 green VDU; 132 col 165 cps printer: N/P	O/S: DBASIC	Takes up to 5 work stations: fully integrated system: options — additional dual 5¼" F/D (1MB) and 12 MB H/D: (S)
Dynabyte DB8/1 (£1,500)	Dynabyte UK/Europe Ltd: 0723 65559 (6)	32-64K RAM; Z80; S100 bus: 2 RS232 ports: 1 P/P	CP/M: BASIC: Cobol: Pascal	Expands to multi-user system: option — dual 8" F/D (1MB), £2,000; also DB8/2 with dual 5¼" F/D (400K), £3,000 (E)
Equinox 200 (£9,995)	Equinox: 01-739 2387 (N/A)	64-256K RAM; Z80; 10MB H/D; 15", 24x80 b&w VDU; 150 cps printer: 6 S/P	CP/M: BASIC: Cobol Fortran: MVT/FAMOS	(S&H)
Euroc (£7,995)	Eurocalc Ltd: 01-405 3113 (TBA)	64K RAM; 8080A; dual 8" F/D (1MB); 15", 25x80 b&w VDU; 132 col 140cps printer	CP/M: CBASIC: A: U:	A year's maintenance and stationery supply inc: (S)
Executive Minicomputer	Binatone 01-903 5211	See Video Genie		
Exidy Sorcerer (£650)	Liveport Data Products 0736 798157 (27)	8-32K RAM; Z80; RS232; 1 P/P; S100 connector: 30 x 64 VDU I/O	O/S: ExBASIC (ROM): Editor: A: CP/M: Algol: Fortran	High res graphics capability: 16K version, £760; 32K £859; 48K, £960; option — dual 5¼" F/D (630K), £1,200; User programmable character set: (I)

List of Abbreviations

A Assembler	F/D Floppy disc	M/A Macro assembler	S/P Serial port
B BASIC	G/C Graphics card	N/A Not available	T/E Text editor
C Cassette	H Hardware	N/P Numeric pad	TBA To be announced
E Extensive	H/D Hard disc	O/S Operating system	U Utility
	I Introductory	P/P Parallel port	
	Int Interface	S Software	

Please note: Software items listed in *italic* are not included in the basic price of the equipment. All prices are *exclusive* of VAT.

Machine (Price from)	Main Distributor/s (No. of Dealers)	Hardware	Software	Miscellaneous (Documentation)
HP 85 (£2,240)	Hewlett Packard Ltd: 0734 784774 (16)	16-32K RAM; C.P.U.: 5" 16x32 b&w VDU; C (200K); 64 cps printer; RS232 port; 4 P/P	BASIC:	Full dot matrix graphics; N/P; compact portable unit: (S)
IMS 5000 (£1,935)	Equinox: 01-739 2387 (20)	32-64K RAM; Z80: dual 5 1/4" F/D (320K)	CP/M BASIC; Cobol; Fortran; Pascal	3 drives option: (S&H)
IMS 8000 (£3,515)	As above	64-256K RAM; Z80: dual 8" F/D (1MB)	CP/M; BASIC; cobol; Fortran; Pascal; Micro Cobol; MVT; FAMOS; Multi-user	4 drives option: (S&H)
IMSAI VDP 42 (£3,900)	Computermarket: 0603 615089 (TBA)	32-64K RAM; 8085: dual 5 1/4" F/D (400K); 9", 24x80 b&w VDU: 1 S/P; 1 P/P	IMDOS (CP/M comp); A: ExBASIC; U; CBASIC; Cobol; Fortran	Supports 8 additional F/D drives: also available, VDP 44 with F/D (780K), £4,400: (H)
IMSAI VDP 80 (£6,200)	As above	32-64K RAM; 8085: dual 8" F/D (1.2MB); 12", 24x80 b&w VDU: 1 S/P; 1 P/P	IMDOS; A: ExBASIC; U; CBASIC; Cobol; Fortran	(H)
ITT 2020 (£867)	ITT: 0268 3040 (15)	16-48K RAM; 6502	Monitor: A: ExBASIC; Dis A:	360x192 high res graphics; Ex-BASIC in 6K ROM; options — single 5 1/4" F/D (116K), £425; 16K RAM, £110; RS232 port, £96; 32K system, £931; 48K system, £995: (B)
LX-500 (£3,500)	Logabax Ltd: 01 965 0061 (13)	32K RAM; Z80: dual 5 1/4" F/D (180K); 12" 25x80 b&w VDU: 100cps printer	DOS; BASIC; A	Other printers available: (S)
Megamicro (£6,080)	Bytronics: 0252 726814 (5)	256K; 8080A: dual 8" F/D (1MB); 12", 20x80 b&w VDU: 120cps printer; 2 S/P; 2 P/P	CP/M; U	(H&B)
Micro-Engine (£2,080)	Pronto: 01-599 3041 (TBA)	64K RAM; MCP 1600; 2 RS232 ports; 2 P/P	BASIC; Pascal	CPU has user written word set: options — dual 5 1/4" F/D (1MB) and dual 8" (2MB): (S&H)
Microstar 45 Plus (£4,950)	Data Efficiency: 0442 57137 (TBA)	64K RAM; 8085: dual 8" F/D (1.2MB); 3 S/P; RS232 port	STARDOS; CP/M; BASIC; Cobol; Fortran	(E)
MSI 6800 (£1,203)	Strumech: 05433 4321 (5)	16K RAM; 6800; C: 9", 16x64 b&w VDU: 1 S/P	BASIC; Mini A: U	Up to 8 serial or parallel ints possible: (S&H)
MSI 6800 System 1 (£2,175)	As above	32K RAM; 6800: dual 5 1/4" F/D (160K); 9" 16x24 b&w VDU: 1 RS232 port	DOS; BASIC; U; A: Fortran	As above: option — dual 8" F/D (624K), £1,640: (S&H)
MSI 6800 System 2 (£7,500)	As above	56K RAM; 6800: single 8" F/D (312K); 10MB H/D; RS232 port: 9", 16x64 b&w VDU	DOS; BASIC; Multi-user BASIC; A	Rack mounted: options — dual 8" F/D (624K), £1,640; 10MB H/D, £4,250: (S&H)
MSI System 7 (£5,200)	As above	56K RAM; 6800: dual 5 1/4" F/D (640K); 9", 16x24 VDU: 1 P/P	DOS; BASIC; A	Choice of FDOS, SDOS or Flex; also option — 10MB H/D: (H&S)
North Star Horizon (48K, £4,650)	Comart: 0480 215005; Comma: 0277 811131; Equinox: 01-739 2387 (20)	24-56K RAM; Z80A: dual 5 1/4" F/D (360K); 15", 24x80 b&w VDU: 150 cps printer; 2 S/P; 1 P/P	DOS; BASIC; CP/M; Cobol; Fortran; Pascal	(E)
Oxford Mini-computer	Binatone 01-903 5211	See Video Genie		
PET 8K,16K & 32K (£550, £675 & £795)	Commodore: 01-388 5702 (150)	8-32K RAM; 6502; C: 9" 25x40 VDU: IEEE488 port	O/S; BASIC; A; Forth Pilot:	BASIC in 8K ROM; options — dual 5 1/4" F/D (353K), £795; same, but (800K), £995, plus, with the 2001-8, £30 for the disc operating ROM: (I)
Powerhouse 2 (£1,175)	Powerhouse Micros: 0422 48422 (TBA)	32-64K RAM; Z80A: 5", 27x96 b&w VDU: 1 P/P; RS232 port	FDOS; BOS; BASIC; ExBASIC; (14K EPROM), £260	Graphics card available, £190; option — dual 5 1/4" F/D (700K): (I)
Rair Black Box (£2,300)	Rair: 01-836 4663 (N/A)	32-64K RAM; 8085: dual 5 1/4" F/D (160K); 2 RS232 ports	CP/M; BASIC; Cobol; Fortran; M/A	16K RAM expansion, £250; dual 5 1/4" F/D (520K), £1,000: (H)
Research Machines 380-Z (£1,048)	Research Machines: 0865 49791 (N/A)	16-56K RAM; Z80A; C: RS232 port:	Tiny BASIC; graphics; A: ExBASIC; CBASIC; Cobol; Fortran; Algol; CP/M; U:	Designed for education: high res graphics being developed: options — dual 5 1/4" F/D (168K), £895 and dual 8" F/D (1MB), £1,695: 56K version, £1,654: (S)
SDS 100 (£4,290)	Airamco: 0294 57755 (11)	64K RAM; Z80: dual 8" F/D (1MB); 12", 24x80 VDU: S100 bus; RS232 port; N/P; 1 P/P	CP/M; A: ExBASIC; Cobol; Fortran	Facility for 8K PROM: (E)
S.E.E.D. System One (£2,175)	Strumech: 05433 4321 (4)	32-56K RAM; 6800: dual 5 1/4" F/D (160K); 9", 16x24 b&w VDU: RS232 port	DOS; BASIC; U; Fortran; Cobol; M/A	Up to 8 I/O ports: max of 4 F/D drives: option — dual 8" F/D (624K): (E)
Semel 1 (£2,900)	Strutt Electrical: 0822 5439 (N/A)	16-64K RAM; Z80: single 8" F/D (250K); 12", 24x80 b&w VDU: RS232 port	BASIC; Cobol; Fortran	Supports up to 8 drives option — single 8" F/D (250K), £500: (I)
Sharp MZ-80K (£520)	Sharp Electronics (UK) Ltd: 061 205 7321 (22)	6-34K RAM; Z80; C: 10", 24x40 b&w VDU	BASIC; A:	Graphics: loudspeaker; BASIC in 14K RAM; 34K machine, £740: (B)
Simpelec Mk 1 (£6,900)	Compelec: 01-636 1392 (N/A)	64K RAM; Z80: dual 8" F/D (1MB); 12", 24x80 VDU: 2 S/P; 1 P/P	CP/M; BASIC	Also Mark II with 2MB F/D, £7,900; will upgrade further: (S&H)
Sirocco (£3,900)	Elvingate Computers: 069 245189 (TBA)	64K RAM; Z80: dual 5 1/4" F/D (940K); 12", 24x80 VDU: RS232 port	CP/M; CBASIC; Cobol; MBASIC; Fortran	Direct memory addressing; memory mapped VDU: free standing keyboard: option — 10MB H/D
Smoke Signal Chieftain 1 (£3,050)	Windrush Micro Designs 069 245189 (TBA)	32-64K RAM; 6800: dual 5 1/4" F/D (160K); 12", 24x80 VDU: 112 cps printer; RS232C port	DOS; BASIC; DBASIC; RBASIC; A: Fortran; U	Also Chieftain 3 with dual 8" F/D (1MB), £3,950 (E)
Solitaire WP & BS200 (£6,750 & £7,950)	Solitaire KPG: 04252 71448 (TBA)	64K RAM; 8085: 14" VDU (with own CPU); 45 cps printer; CPU port: dual 5 1/4" F/D (700K) with "WP", and dual 8" F/D (960K) with "BS200"	DOS; BASIC (optional on the "WP")	All Solitaire systems are compatible: graphics on 11x13 dot matrix: (S)
Solitaire/HBS100 (£9,500)	As above	64K RAM; 8085: 10MB H/D; 14" VDU (with own CPU); 200 cps printer; CPU port	DOS; BASIC	Up to 8 interface terminals can be used: also HBS200 with 20-80 MB of H/D; HBS100 limit is 40MB: (S)

Machine (Price from)	Main Distributor/s (No. of Dealers)	Hardware	Software	Miscellaneous (Documentation)
Sord M100 ACE (£2,650)	Midas Computer Services Ltd: 0903 814523	48K RAM: Z80: single 5¼" F/D (143K): 12" 24x64 col VDU RS232 port	O/S: BASIC	With colour graphics: 8K ROM: option — single 5¼" F/D, £300: (I)
Sord M223 (£3,500)	As above	64K RAM: Z80: single 5¼" F/D (350K): 12", 24x80 b&w VDU: S100 bus: RS232 port	O/S: BASIC	Other configs possible: extra F/D, £450: (I)
Superbrain (£1,995)	Icarus: 0632 29593 (TBA)	64K RAM: 2xZ80: dual 5¼" F/D (320K): 12", 25x80 b&w VDU: S100 bus: RS232: TRS80 port	CP/M: A: BASIC: Cobol: Fortran: APL Pascal	Limited graphics: mainframe int available: options — dual 5¼" F/D (320K): dual 8" F/D (2.4MB): 8-120 MB H/D: (S&H)
Tandberg EC10 (£5,000)	Tandberg: 0532 35111: (N/A)	50K RAM: 8080A: single 8" F/D (250K): 12", 25x80 b&w VDU: RS232 port	ExBASIC (24K): Multi-user BASIC: A: U: Cobol	(S&H)
Tandy TRS 80 Level 1 (£380)	Tandy: 021 556 6101 (200)	4-16K RAM: Z80: C: 12", 16x64 b&w VDU	BASIC: A:	BASIC in 4K ROM: upgradable to level 2: (I)
Tandy TRS 80 Level II (£515)	As above	4-48K RAM: Z80: C: 12", 16x64 b&w VDU: RS232 int: 1 P/P	BASIC: M/A: Fortran	16K machine includes N/P: 4-16K upgrade, £120 (£85 without pad): max config, £1,005: option — single 5¼" F/D (78K), £478 (max of 4): (I)
TECS (£1,600)	Technalogs: 051 724 2695 (TBA)	16-56K RAM: 6800: 8K PROM: RS232 port: C int	BASIC: T.DOS: Prestel: Monitor:	256 ch graphics: Prestel compatible: plugs into standard TV: option — dual 5¼" F/D (320K), £800: (S&H)
TEI 208 (£3,841)	Abacus: 01-580 8811 (5)	32-60K RAM: 8080/8085: dual 5¼" F/D (320K): 9", 24x80 green VDU: 3 S/P: 3 P/P	CP/M: BASIC: Cobol: Fortran: Pascal: Algol	(S&H)
TEI 212 (£4,886)	As above	32-60K RAM: 8080/8085: dual 8" F/D (1MB): 15", 24x80 green VDU: 3 S/P: 3 P/P	CP/M: BASIC: Cobol: Fortran: Pascal: Algol	(S&H)
Terodec DPS 64/1-4 (£3,014)	Terodec (Micro-systems) Ltd: 0344 51160: (TBA)	64K RAM: Z80: dual 8" F/D (1MB): 12", 24x80 b&w VDU: 2 S/P: 3 P/P	CP/M: BASIC: Cobol: CBASIC: Fortran: Algol: Pascal	TMZ 80, enhanced model in integral work station, £5,495 (with 4MB F/D): DPS 64 with 2MB F/D is £3,319: options — dual 8" F/D (1MB), £1,150: dual 8" F/D (2MB), £1,455: (S&H)
Vector Graphics MZ (£2,595)	Almarc: 0602 625035: Sintrom Microshop: 0734 85464: Metrotech 0895 57780: (5)	56K RAM: Z80: dual 5¼" F/D (630K): 3 S/P: 2 P/P	DOS: BASIC: A: CP/M2: Algol: CBASIC: Cobol: Fortran: Pascal	Includes PROM burner: also System B with graphics and N/P, £3,195: (E)
Video Genie EG 3003 (£378)	Lowe Electronics: 0629 2817: Binatone: 01-903 5211 (N/A)	16K RAM: Z80: 500 bps C: 32x64 TV int: extra C int: 1 P/P	BASIC: M/A: Fortran	BASIC in 12K ROM: graphics available: F/D under development: Binatone call their 16K model "Executive Minicomputer" and a 4K version, "Oxford Minicomputer" — prices TBA: (I)
Zenith WH-11A (£4,359)	Heath Ltd 0452 29451 and 01-636 7349 (N/A)	LSI 11: 16-32K RAM: 25x80 VDU: S/P: P/P	O/S: BASIC: Fortran: A: U:	PDP 11 compatible: option — dual 8" F/D (512K): (S&H)
Zenith Z89 (£1,490)	As above	16-48K RAM: Z80: single 5¼" F/D (102K): 12", 25x80 b&g VDU: RS232	BASIC: A: H.DOS: CP/M: MBASIC: CBASIC: Fortran	3 drives option: (I)
Zentec (£5,700)	Zigal Dynamics Ltd: 02405 75681 (1)	32-64K RAM: 2x8080: dual 5¼" F/D (512K): 15", 25x80 b&w VDU: RS232 port	O/S: A: U: BASIC: Micro Cobol	User programmable character set: option — dual 8" F/D (1MB): (S)
Zilog MCZ 1/05 (£4,200 — portable)	Micropower: 0256 54121: Memec: 084421 5471 (N/A)	64K RAM: Z80: dual 8" F/D (600K): RS232 port	RIO O/S: M/A: U: BASIC: Cobol: Fortran: Pascal	Debug in 3K PROM: also available as desk top unit or R/M model, both £4,800: (S&H)
Z Plus (£4,000)	Rostronics: 01-874 3665 (TBA)	32-64K RAM: Z80: dual 8" F/D (1MB): 2 S/P: 2 P/P	CP/M: A: U: BASIC: Cobol: Fortran: Pascal	(S&H)

SINGLE BOARDS

Machine (Price from)	Main Distributor/s (No. of dealers)	Hardware	Software/Firmware	Documentation	Miscellaneous
Acorn (£65)	Acorn: 0223 312772 (N/A)	1.1/8K RAM: 6502: EPROM socket: Hex K/B: C int: 8 digit LED display: up to 16 ports: options — Eurocard 64 way connector: VDU card: Full K/B card	½K monitor: BASIC		Kit: programmable address linking; on board 5V regulator: available assembled, £79 (S&H)
Aim 65C (£265)	Pelco: 0273 722155 (4)	1-4K RAM: 6502: 12K ROM: full K/B: 20 char LED display: 20 char thermal printer: Cx2: RS232 port.	A: Dis A: T/E: 8K monitor in ROM		Available as S100 system with A or BASIC in ROM (£480) from Portable Micros (0280 702017): they also have briefcase version (£750) (E)
Cromemco SC (£260)	Comart: 0480 215005 (17)	1K RAM: Z80A: 8K EPROM sockets: RS232 port: 3 P/P: option — S100 bus.	Monitor and control BASIC in EPROM		5 program interval timers: can put own BASIC programs in EPROM (E)
ELF II (£114)	Newtronics: 01-348 3325	1/4K RAM: RCA 1802: Hex K/B: 2 digit LED: TV int: C int: RS232 port: options — 4K RAM, £69; full K/B; VDU card	1K monitor: A: Dis A: T/E: BASIC:		TTY, n-line decoders: low resolution graphics (high resolution available) kit (H)
Explorer (£295)	Newtronics: 01-739 1582 (15)	4K RAM: 8085: Hex K/B: RS232 port: S100 bus: C int: options — 6 slot S100 £32; 8K EPROM sockets £50.	2K monitor: CP/M: BASIC		Programmable 14 bit counter: kit (S&H)
H8 (£262)	Heath: 0452 29451 (TBA)	4K RAM: 8080A: Octal K/B: 6 digit LED: speaker: options — single 5¼" F/D (102K), £399; 16K RAM, £314; C int, £72	1K monitor: BASIC in RAM: FORTRAN: T/E: A: U:		Kit (S&H)
Hewart 6800S (£299)	Hewart: 0625 22030 (N/A)	16K RAM: 6800: full K/B: VDU int: 2xC int; 1 S/P: 2 P/P: option — 16K RAM, £90	1K monitor: A: T/E		Can be upgraded with 6809 (H)
Hewart 6800 MkIII (£152)	As above	1K RAM: 6800: VDU board: options — single 5¼" F/D (75K), £350; PROM programmer, £32: calculator board, £32	1K monitor		(H)

interface components



NASCOM IMP
PLAIN PAPER PRINTER
FOR ONLY
£325
PLUS VAT
AVAILABLE EX-STOCK
IDEAL FOR WORD
PROCESSING

NASCOM IMP AVAILABLE EX-STOCK

The incredibly low-price Nascom IMP is now available off the shelf at Interface Components. It plugs into any microcomputer system with a serial RS 232 Interface, including the popular Nascom 1 & 2.

Although an impact matrix printer, its versatile feed mechanism allows it to accept A4, foolscap and quarto letterheads making it suitable for word processing applications. And it's quiet too. Line printers and many typewriters are deafening by comparison.

Finished in a smart blue plastic enclosure, the IMP is only £325 plus VAT (post and packing extra) completely assembled.

FEATURES

- 80 characters wide
- 60 lines per minute
- Bi-directional printing
- 10-line print buffer
- 96 character ASCII set (includes \$, #, £)
- Automatic CR/LF
- 8½" paper (pressure feed)
- 9½" paper (tractor feed)
- Baud rate 110 to 9600
- External signal for optional synchronisation of baud rate

ORDER FORM

Send your orders to:
Interface Components Ltd, Oakfield Corner,
Sycamore Road, Amersham, Bucks HP6 6SU.
Telephone: 02403 22307 Telex: 837788.

Please send me.....Nascom Imps at £325 each
plus VAT at 15% plus £2.50 p&p.

Name _____

Address _____

Access or
Barclaycard No. _____

Personal callers welcome

IN STORE

DIRECT ACCESS

Machine (Price from)	Main Distributor/s (No. of dealers)	Hardware	Software/Firmware	Documentation	Miscellaneous
Mk 14 (£39.95)	Science of Cambridge: 0223 311488 (N/A)	8060: 1/4-2K RAM: Hex K/B: 7 char LED; options - VDU int (32x16 with graphics), £29; C int, £6; PROM prog, £10, 2K memory expansion, £15	Machine code		Designed for control applications rather than high level computing expansion (H)
Nascom 1 (£165)	Nascom: 02405 75155 (20)	4K RAM: Z80: full K/B: TV int: 2 P/P: 1 S/P	2K monitor: <i>BBASIC: tiny BASIC: A: T/E: U</i>		Now available as Nascom 2 with 8K RAM and 8K microsoft BASIC in ROM, £295
SBC 100 (£135)	Airanco: 0294 57755 (11)	1K RAM: Z80: 8K ROM: S100 1 S/P: 1 P/P: option - voltage regulator	1K monitor: <i>DOS in ROM</i>		Kit: available assembled, £196 (E)
Superboard (£188)	MBM: 01-981 3993 (N/A)	4-8K RAM: 6502: 10K ROM: full K/B: VDU int: C int: options - RS232; single 5 1/4" F/D (100K), £316; 8K RAM, £188	BASIC in 8K ROM:		Available with 32K RAM and single 5 1/4" F/D, £867 (S&H)
SYM-1 (£160)	Newbear: 0635 30505 (N/A)	1-4K RAM: 6502: 244 bps C int: VDU int: 2x6522 ports: option - TV int.	4K monitor: <i>BASIC: A</i>		Can be expanded to 64K RAM (S&H)
Triton 4.1 (£286)	Transam: 01-402 8137 (N/A)	2K RAM: 8080: 3K ROM: full K/B: 16x64 VDU or TV int: C 1 S/P: option - 2K RAM, £30	1K monitor: 2K BASIC: U		64 character graphics: 8 levels interrupt: kit (S&H)
Triton 5.1 (£294)	As above	2K RAM: 8080: 4K ROM: full K/B: 16x64 VDU or TV int: C int: 1 S/P: C: options - 8K RAM, £97; 8K EPROM, £97	1 1/2K monitor: 2 1/2K Ex-BASIC: U		Kit: assembled version, £393 (S&H)
UK 101 (£219)	Computer Shop: 01-440 7033	4K RAM: 6502: full K/B: 16x48 VDU or TV int: C int: RS232 port: option - 4K RAM, £49	1K monitor: 8K BASIC: <i>Dis A: U</i>		Graphics: will run Superboard software (S&H)

List of Abbreviations

A Assembler
B BASIC
C Cassette
E Extensive

F/D Floppy disc
G/C Graphics card
H Hardware
H/D Hard disc
I Introductory
Int Interface

M/A Macro assembler
N/A Not available
N/P Numeric pad
O/S Operating system
P/P Parallel port
S Software

S/P Serial port
T/E Text editor
TBA To be announced
U Utility

Please note: Software items listed in *italic* are not included in the basic price of the equipment. All prices are *exclusive* of VAT.

USER GROUPS INDEX

DIRECT ACCESS

Here are the details of additions and changes recently notified. A full index will be published next month.

EAST ANGLIA

Anglia Computer User Group.
Contact Jan Rejzl, 128 Templemere, Sprowston Road, Norwich NR3 4EQ

NORTH LANCASHIRE

North Lancs User Group.
Contact John Robinson, 12 Harold Ave., Blackpool, Lancashire.

LONDON

SELMIC (South East London Microcomputer Club). £5 subscription. Meetings at Woolwich Polytechnic.
Contact John Williamson, 129 Greenvale Rd., Eltham Park, London SE9 1 PG.
Tel: 01-850 4195

Thames Valley Amateur Computer Club now meets first Tuesday monthly (was Thursdays)

East London Computer Club chairman is now Dr. Graham Crisp, 45 Leadale Ave., Chingford, London E4 8AX.
Tel: 01-529 6010

MIDDLESEX

Sunbury Amateur Computer Club. Membership free.
Contact Mr S N Taylor, 8 Priory Close, Sunbury on Thames, Middlesex, TW16 5AB. Tel Sunbury 86649.

DIARY DATA

DIRECT ACCESS

Wembley, England	IMEC - European Information Management Exhibition & Conference. Clapp & Poliak Europe Ltd., 232 Acton Lane, London W4 5DL. Tel: 01-995 4806	Feb 18 - Feb 21
Bournemouth, England	BEX - Business Equipment Exhibition. Douglas Temple Studios Ltd., 104b Old Christchurch Rd., Bournemouth, Dorset, Tel: 0202 20533	Feb 20 - Feb 21
Swansea, Wales	OFFEX - Office Equipment Exhibition. Phoenix Exhibitions Ltd., 1st Floor, Burrows Chambers, East Burrows Rd., Swansea. Tel: 0792 460364	Feb 20 - Feb 22
Birmingham, England	IEA - International Instruments, Electronics & Automation Exhibition. Industrial & Trade Fairs Ltd., Radcliffe House, Blenheim Court, Solihull, West Midlands, B91 2BD. Tel: 021 705 6707	Feb 25 - Feb 29
Milan, Italy	International Exhibition of Numerical Control, Automation & Industrial Robots. CEU S.p.A., Via Monte Rose 21, 21049 Milan	Mar 3 - Mar 7
Birmingham, England	Computermarket '80, Couchmead Ltd, 42 Great Windmill Street, London W1V 7PA. Tel: 01-437 4187	Mar 4 - Mar 6
London, England	Microforum Europe. Business Equipment Trade Association, 109 Kingsway, London WC2B 6PU. Tel: 01-405 6233	Mar 11 - Mar 13
Manchester, England	Computermarket. Couchmead Ltd., 42 Great Windmill Street, London W1V 7PA. Tel: 01-437 4187	Mar 11 - Mar 13
Sheffield, England	Business Efficiency & Office Equipment Exhibition. Gwen Shillaber Design, 81 Whiteladies Road, Clifton, Bristol, BS8 2NT. Tel: 0272 312850	Mar 11 - Mar 13
Glasgow, Scotland	Computermarket '80. Couchmead Ltd., 42 Great Windmill Street, London W1V 7PA. Telephone: 01-437 4187	Mar 18 - Mar 20
London, England	Computermarket '80. Couchmead Ltd., 42 Great Windmill Street, London W1V 7PA. Telephone: 01-437 4187	Mar 25 - Mar 27

**DIRECT
ACCESS****DIARY DATA**

London, England	Viewdata '80 Exhibition. Online Conferences Ltd., Cleveland Road, Uxbridge, UB8 2DD. Tel: 0895 39262	Mar 26 - Mar 28
Brighton, England	Computer Aided Design Conference & Exhibition. Iliffe Promotions Ltd., Dorset House, Stamford Street, London SE1 9LU. Tel: 01-261 8000	Mar 31 - Apr 2
London, England	Peripherals '80 Exhibition. Iliffe Promotions Ltd., Dorset House, Stamford Street, London SE1 9LU. Tel: 01-261 8000.	Apr 16 - Apr 17
London, England	All Electronic Show. All Electronic Show, 34-36 High Street, Saffron Walden, Essex. Tel: 0799 22612	Apr 29 - May 1
Liverpool, England	Mersey Micro Show. Online Conferences Ltd., Cleveland Road, Uxbridge UB8 2DD. Tel: 0895 39262	April 30 - May 2
Brussels, Belgium	Compec Europe Exhibition. Iliffe Promotions Ltd., Dorset House, Stamford Street, London SE1 9LU. Tel: 01-261 8000.	May 6 - May 8
Manchester, England	Business Efficiency & Office Equipment Exhibition, Gwen Shillaber Design, 81 Whiteladies Rd., Clifton, Bristol BS8 2NT. Tel: 0272 312850	May 13 - May 15
Anaheim, USA	National Computer Conference and Exhibition (NCC). 210 Summit Ave., Montvale, NJ 07645	May 19 - May 22
Dallas, USA	Int. Telecommunications Exbn - INTELCOM. Horizon House - Microsol Inc., 25 Victoria Street, London SW1H OEX. Tel: 01-222 0466	May 19 - May 23
London, England	International Word Processing Exhibition and Conference. Business Equipment Trade Association, 109 Kingsway, London WC2B 6PU. Tel: 01-405 6233	May 20 - May 23

**DIRECT
ACCESS****TRANSACTION FILE****For sale**

Tandy TRS-80. . . level II, 16K, complete with video, tape recorder light pen, RS232 printer interface, manuals etc. Over £1,000 new (at current prices) - accept £600 cash. Prefer buyer collects, so can demonstrate. Fitted wall cabinet also available. Phone Dave Holloway on Asthall Leigh (099 387) 241, evenings/weekends.

PET 2001-8. . . 9 months old, used only in home - £475. Phone Chris McDermott on Stewarton (05603) 4182.

Teletype ASR33. . . good working order, complete with plinth and paper support - £400 ono. Phone High Wycombe 35975 or 20707 (office hours).

PDP8 minicomputer. . . (early transistor version). 4K core, teletype interface, 4 discs, manuals and some software. Bulky system, must be collected. Phone Connell on High Wycombe (0494) 31314 - negotiate around £295.

Technico TMS 9900 Development Board. . . has monitor PROM, 32 bits I/O, RS232 interface, 2708 EPROM programmer. Cost new over £300 - will sell for £150. Phone 02602 78293.

PET 2001-8K. . . new March 1979. Includes green screen, 60 games and PET routines, cover, manual. Perfect condition - £450. Also Teletype ASR33 terminal/printer. Perfect working order, includes PET interface and software/RS232 interface; spare parts (including motor). Most mechanics/stand/20ma interface/manuals - £350. Phone R. Wilmot on Horsham (0403) 69835.

Elector BASIC card. . . 4K BASIC in ROM, V-24 I/F, bus board + 77-68 RAM card - 2K RAM. Sockets throughout, £100 the lot or may split. Phone 021 784 6364 (Pete).

4K Floating Point BASIC (CCSOFT). . . for Nascom-1. In 4x2708 EPROMS, with documentation - £35. Phone 0702 218662.

Motorola 6800 D2. . . micro-processor kit, built and tested, with documentation and programs; plus extra RAM, £115. Phone Cambridge (0223) 314934.

PET 2001-8K. . . as new, only used at home, plus manuals - £480 ono. Phone 095 276 320, evenings or weekends (near Workington).

Mk.14. . . revised monitor, I/O, tape interface, improved keyboard, extra RAM, single step, PSU, instructions - all for £50 or will split. Phone 021-357 3488.

Smart 1. . . Nascom memory expansion, 16K RAM. Fully built, with connectors and spares - £100. P. Watson, 101 Village Road, Bromham, Bedford MK43 8HU. Phone Oakley 2867. Also MEK D2 for sale.

Triton computer. . . 7K memory on board, 1K monitor and 2K Tiny BASIC - 10 cassettes containing games plus leads and case. Securicor delivery - £300. Contact Mr Brian Ewan, 16 Fairacres, Harwood, Bolton BL2 3NT. Phone 0204 389498.

TI-57. . . 50 merged step programmable calculator, 8 memories, £25 ono. Includes mains recharger, full instructions and some programs - 6 months old. Contact Andrew Watson on Bisley

(045 277) 233, evenings or weekends.

Casio FX-201P. . . programmable calculator, 127 steps with instruction manual - as new, £32. Contact Tim Cook, House six, Room eight, Edward Square, Middlesbrough, Cleveland TS1 30H

Nascom 1. . . tested by Nascom Microcomputers and fitted with latest NASYS 1 2K monitor. Full documentation and 3 amp PSU. No case - £150 ono. Phone Colchester 74791, evenings.

TI-59. . . programmable calculator, 9 months old, with maths/utilities library, programming aids and astrology speciality packettes, mains adaptor and supporting

documentation. Contact Mr K. Barnes, 6 Blaven Walk, Fareham, Hants or phone Fareham 280642 after 6pm any evening.

Teletype ASR33. . . TTY terminal/printer with stand; as new - £425. Phone Bradford 683608

VDU. . . for sale or swap for microcomputer board, RS232 or 20ma loop ASCII i/f, 24x80; full or half duplex; 50-9,600 baud. Upper case keyboard. Excellent order, complete with full manufacturer's circuits and manual. Also two oscilloscopes (one portable) for sale or barter as above. Phone 0342 22105 anytime.

Mini computer. . . suitable for RTTY use but capable of expansion in other modes if desired. To be used in conjunction with ST5 Terminal Unit and domestic TV set. Contact L. Roffey, 15 The Furrows, Harefield, Middlesex UB9 6AT.

Teletype ASR33. . . punch, reader, stand, ASCII code, very clean, overhauled last year - £150 ono. Logabax, printer, LX180, 180 cps, synchronous, 7x7 matrix, continuous form, fan folded, tractor feed, paper width 4" to 15", little used - £400 ono. Both the above working with all manuals and diagrams. Phone 021-358 3841 anytime.

Ciphers Cub VDU. . . 16 lines by 64 ch, separate full keyboard, automatic scrolling, upper and lower case, clear 7x9 dot matrix characters, CCITT V24 or current loop interface, switchable baud rates etc. Nearly new, cost £437, accept £250. Phone Leatherhead 74674, evenings.

Challenger 2P. . . advanced micro, 64x32 video with modulator for UK TV. 8K BASIC, 4K RAM, cassette interface, sound O/P, D/A converter (for advanced sound O/P), remote AC control facility. Fully expandable via mother board. As new, with manuals - only £350. Phone Leo on Harrogate 888912, evenings.

Wanted

I am the proud owner of a PET (32K) and would like to find other PET owners in my area with whom I might exchange views and knowledge. Anyone interested, please contact Mr Allan Clarke, 35 Campbell Street, Gainsborough, Lincs DN21 2PJ.

Wanted for nostalgic reasons. . . information leading to the acquisition of an instruction display panel from an NCR 500. Phone 01-866 1179 and ask for David.



puter for those "number crunching" jobs which just take too long (or do not fit into 64K) on the home micro. All in all, the concept certainly seems sound, but obviously the price needs to be right.

I'll be writing in PCW on other related developments in micro communications in a new column called "Network Notes" which will appear every few months—

according to needs. In the meantime, keep writing in with those ideas.

Finally, in next month's PCW I shall be reviewing the communications capability of all the major micro systems, as well as assessing the products of modem suppliers.

Starting in our May edition, David Hebditch will be presenting a new monthly series on Man/Machine Interaction.

PASCAL Cont. from Page 73

tions and our string handling functions and procedures cannot cope with literal strings (e.g. LENGTH ('HI THERE')) will cause a compiling error.

The UCSD string functions and procedures are as follows:

1 FUNCTION LENGTH (STRING): INTEGER returns the number of characters in the string STRING.
2 FUNCTIONS POS (STRING, SOURCE): INTEGER returns the position of substring in string SOURCE.

If more than one occurrence exists, POS will return the first. If no occurrence exists, POS will return 0.

3 FUNCTION CONCAT (SOURCE1, SOURCE2, . . .): STRING returns a string which is the concatenation of the set of strings passed in the parameter list taken in order. Note the replacement version in Box 8 is a procedure rather than a function and only concatenates a pair of strings.

4 FUNCTION COPY (SOURCE, INDEX, SIZE): STRING returns a string containing the substring of length size starting at position INDEX in STRING.

5 PROCEDURE DELETE (DESTINATION, INDEX, SIZE) deletes SIZE characters from the string DESTINATION starting at position INDEX.

6 PROCEDURE INSERT (SOURCE, DESTINATION, INDEX) inserts substring SOURCE into string DESTINATION starting at position INDEX.

In addition, Box 8 contains two procedures to read and write strings (STREAD and STWRITE). This is managed at system level in UCSD PASCAL so READ and WRITE will accept strings as parameters.

Exercise: Write a program to read in a positive integer less than 10,000 and print out the value in words, e.g.:

input 1705
output ONE THOUSAND SEVEN HUNDRED AND FIVE

Use a function to extract the digits from the number, one at a time starting with the thousands, and a variable parameter to convert the digit into a word. Anything from 10 to 99 will need special treatment, especially up to 19. Use CONCAT to put the output string together.

Conclusion

This chapter has expanded the concepts of the procedure beyond that of a means of modularising programs. Value parameters are passed when there is no requirement to return their values at the end of the called procedure. Functions are used when a single result of a simple data type is required and variable parameters are used for more complicated returns. We concluded with a collection of string handling functions and procedures designed to emulate UCSD's string handling facilities.

We should like to express our thanks to Equinox Computer Systems Ltd., for their continued loan of a 56K Horizon on which the string handling procedures were developed.

Look up table

PASCAL Reserved Words
FUNCTION

Computer Jargon
Stack
Push
Pop
Actual Parameter
Formal Parameter
Value Parameter Call-by-value
Variable Parameter Call-by-Name
Side-Effect

UCSD Exceptions
STRING = Standard type
Section 4 details implications and standard functions available

```

1 PROGRAM STRINGS ;
2 CONST MAXLINE = 80 ;
3 TYPE STRING = ARRAY[1..MAXLINE] OF CHAR ;
4 (*VARIABLES AS NEEDED
5 IN THE MAIN PROGRAM*)
6
7 FUNCTION LENGTH (S:STRING) : INTEGER ;
8 VAR TEMP : 1..MAXLINE ;
9 BEGIN
10     TEMP := MAXLINE ;
11     WHILE S[TEMP] = ' ' DO
12         TEMP := TEMP - 1 ;
13     LENGTH := TEMP
14 END ; (*LENGTH*)
15
16 FUNCTION POSITION (PATTERN, SOURCE:STRING) : INTEGER ;
17 VAR I, J : INTEGER ;
18 FOUND : BOOLEAN ;
19 BEGIN
20     J := 0 ;
21     REPEAT
22         FOUND := TRUE ;
23         FOR I := 1 TO LENGTH (PATTERN) DO
24             IF PATTERN[I] <> SOURCE[J+I] THEN FOUND := FALSE ;
25             J := J + 1

```

MICROMART

TANDY SOFTWARE

Our best seller at the Personal Computer World Show

STAR TREK

Now vastly improved with many extra facilities—it's the best!

£12 post free

Full catalogue of guaranteed quality Level II 4K 16K software on request

Kansas

Unit 3, Sutton Springs Wood, Chesterfield—Tel. (0246) 850357

Phone anytime—Return post service

A SUPERCASE FOR YOUR SUPERBOARD!

Precision formed in super quality ABS - supports a TV

Complete with all screws & holes for instant fitting

Exciting Flame Red (black base) or Ivory (brown base)

COMPUKIT model too!

Instant refund guarantee - or send for leaflet and Superboard software list

MICROCASE

15 Havelock Road Brighton Sussex

£26 plus VAT post free
"TURNS A BOARD INTO A REAL COMPUTER"

A COMPILER FOR TRS-80® BASIC

Southern Software ACCELERATOR speeds execution of BASIC programs by compiling the common statements to Z80 machine-code.

- Develop and debug normally.
- Compile for production work.

Properly-structured, error-free level 2 programs only. £19.95

SOUTHERN SOFTWARE, PO Box 39 Eastleigh Hants. SO5 5WQ

D.J.M. SERVICES, 82 Hilden Park Road, HILDENBOROUGH, KENT, TN119BN
Tel: 0732 832815/357721

All prices include postage & VAT (where applicable)

— BOOKS —

- Computer programs that work (Lee, Beech and Lee) £2.90
- Introduction to personal and business computing (Zaks) £5.00
- Microprocessors - from chips to systems (Zaks) £7.50
- Programming the 6502 (Zaks) £8.00
- 6502 Applications book (Zaks) £9.00

RACAL-ZONAL C-12 CASSETTES

Quality you can rely on - screwed shell, c/w library case and insert card.
5 £3.20; 10 £5.30; 50 £23.90

TDK head demagnetiser - just load like an ordinary cassette. £11.75

MICROMART

PASCAL SUBSET FOR NASCOMS

The first PASCAL subset for cassette-based systems

— produces Z-80 object code directly: no P-codes

— occupies only 4k RAM

— all major PASCAL statements, integer arithmetic,

— WRITE(LN) (formatted), READ(LN), INCH, (D)PEEK, (D)POKE, USER, RANDOM, HALT

— fully recursive procedures

12K BASIC FOR NASCOMS

All the features of a Microsoft BASIC plus:

— 12 digit precision

— PRINT USING, list variables, O/P to printer

— Multi-line recursive user functions

— IF... THEN... ELSE, logical operators

— Renumber, auto line numbering

— line editor, + lots more.

Above run under a new monitor, NASMON, suitable for N1 and N2 systems with memory board.

PRICES:

NASMON monitor supplied in

3 EPROMS: £30

PASCAL supplied on tape: £35

BAS 12K supplied on tape: £30

NASMON, PASCAL, BAS12K: £85

Available Soon: Extended PASCAL (special terms will be available for owners of initial version), Assembler, Disassembler.

Contact:

HISOFT, 11 Bishopswood Road,
HIGHGATE, LONDON, N6
Tel: 01 340 9882

PETS!

Pets — new for old, part exchange your faithful Pet for a new model.

We stock Commodore or Computhink discs, PET printers and teletypes etc.

We also buy used Pets and peripherals for cash.

HORIZONS!

32K static memory (the best) 2 double density discs (2 serial and 1 parallel port) from £1999

HIRE!

PET 8K £4.75 per day

PET 32K £6.95 per day

Teletype 43 £6.00 per day

Apples available

HIGH QUALITY CASSETTES!

C15 41p C30 55p including VAT
Post 20p

Orders over £4.00 free postage

Contact

Richard Mortimore or Chris Phelps
at

MICRO — FACILITIES
01-979 4546/941 1197

**50HZ
SUPERBOARD
£185
(BRITISH STANDARD)**

**PLUS
OFFICIAL
Dealer Support
PLUS**

**ASS/ED, EX/MON and other software
and expansion available. Cursor control,
back space etc. Tape Free.**

**CTS 1 Higher Calderbrook
Littleborough, Lancs OL15 9NL
Tel: Littleborough (0706) 79332 anytime**

Box No. 8 (Cont'd)

```

26 UNTIL FOUND OR (J>LENGTH(SOURCE));
27 IF FOUND THEN POSITION := J ELSE POSITION := 0
28 END; (*POSITION*)
29
30 PROCEDURE STREAD (VAR S:STRING);
31 VAR I,J: 1..MAXLINE;
32 BEGIN
33   I := 1;
34   REPEAT
35     READ(S[I]);
36     I := I + 1;
37   UNTIL EOLN;
38   FOR J := I TO MAXLINE DO
39     S[J] := ' ';
40   END; (*STREAD*)
41
42 PROCEDURE STWRITE (S:STRING);
43 VAR I, J: 1..MAXLINE;
44 BEGIN
45   FOR I := 1 TO LENGTH(S) DO
46     WRITE(S[I]);
47   END; (*STWRITE*)
48
49 PROCEDURE CONCAT(S1,S2: STRING; VAR DESTINATION: STRING);
50 VAR I, L1,L2:1..MAXLINE;
51 BEGIN
52   L1 := LENGTH(S1); L2 := LENGTH(S2);
53   IF (L1 + L2) > MAXLINE
54   THEN WRITELN('STRINGS TOO LONG')
55   ELSE
56     BEGIN
57       FOR I := 1 TO L1 DO
58         DESTINATION[I] := S1[I];
59       FOR I := 1 TO L2 DO
60         DESTINATION[L1 + I] := S2[I];
61     END
62   END; (*CONCAT*)
63
64 PROCEDURE COPY(SOURCE:STRING;VAR DESTINATION:STRING; INDEX,SIZE:INTEGER);
65 VAR I, J: 1..MAXLINE;
66 BEGIN
67   FOR I := 1 TO SIZE DO
68     BEGIN
69       J := INDEX + I - 1;
70       DESTINATION[I] := SOURCE[J];
71     END;
72   FOR I := SIZE + 1 TO MAXLINE DO
73     DESTINATION[I] := ' ';
74   END; (*COPY*)
75
76 PROCEDURE DELETE (VAR DESTINATION:STRING; INDEX,SIZE:INTEGER);
77 VAR I: 1..MAXLINE;
78 BEGIN
79   FOR I := INDEX + SIZE TO LENGTH(DESTINATION) DO
80     BEGIN
81       DESTINATION[I-SIZE] := DESTINATION[I];
82     END;
83   END; (*DELETE*)
84
85 PROCEDURE INSERT(SOURCE:STRING; VAR DESTINATION:STRING; INDEX:INTEGER);
87 VAR I, SIZE: 1..MAXLINE;
88 BEGIN
89   SIZE :=LENGTH(SOURCE);
90   IF SIZE + LENGTH(DESTINATION) > MAXLINE
91   THEN WRITELN('STRING OVERFLOW --INSERTION NOT MADE')
92   ELSE
93     BEGIN
94       FOR I := LENGTH(DESTINATION) DOWNTO INDEX DO
95         DESTINATION[I+SIZE] := DESTINATION[I];
96       FOR I := 1 TO SIZE DO
97         DESTINATION[INDEX + (I-1)] := SOURCE[I];
98     END
99   END; (*INSERT*)
100
101 BEGIN (*MAIN PROGRAM*)
XXX END .

```

The Selective Prom Copier relocatable program Cont. from Page 64

P1	Points to Master	P2	Points to Copy		
0F20,	21	MASTER START ADDRESS (MS)			
0F22,	23	MASTER END ADDRESS (ME)			
0F24,	25	COPY START ADDRESS (CS)			
0F26,		LOOPCOUNT			
0F27,	28	END+			
START	0F29	02	CCL		Clear link and increment
	0F2A	C0 F8	LD(MELo)		Master end address
	0F2C	F4 01	ADI 1		
	0F2E	C8 F9	ST(END + Lo)		
	0F30	C0 F1	LD(MEHi)		Store result at "END +"
	0F32	F4 00	ADI 0		
	0F34	C8 F2	ST(END + Hi)		
REP	0F36	C4 80*	LDI 80*		Load loop total to counter
	0F38	C8 ED	ST(LOOPCOUNT)*(80 or 01)		
	0F3A	C0 E5	LD(MSHi)		LOAD LOW AND HIGH —
	0F3C	35	XPAH1		
	0F3D	C0 E3	LD(MSLo)		BYTES OF M.S. to P1
	0F3F	31	XPAL1		
	0F40	C0 E3	LD(CSHi)		LOAD LOW AND HIGH —
	0F42	36	XPAH2		
	0F43	C0 E1	LD(CSLo)		BYTES OF CS TO PZ
	0F45	32	XPAL.2		
	0F46	C4, 02, 07	LDI 2, CAS		SET FLAG 1
LOOP	0F49	C5 01	LD @ (P1+1)		Master Read and Increment
	0F4B	CE 01	ST @ (P2+1)		Copy Write and Increment
	0F4D	8F 08	DLY 08		DELAY
	0F4F	31 01	XPAL1, XAE		COPY P1
	0F51	40 31	LDE, XPAL1		into E REG.

MICROMART

LIFE

A fine Version of The FAMOUS simulation game for 16K plus APPLES and ITT's

FEATURES:-

FAST in machine code throughout.

EASY PATTERN ENTRY, designed to encourage creative exploration of the game.

FULLY CONTROLLABLE DISPLAY, you can slow up, single step, or even stop, alter and restart.

INSTANT RECALL, you can always get back to your start pattern.

ALL WELL KNOWN SHAPES CAN BE AUTOMATICALLY PLOTTED, you can call up space ships, glider guns, barber poles, tumblers etc. anywhere on the screen.

TAPE SAVE OF YOUR OWN SHAPES, you can store screenfulls of the patterns you discover on tape for later recall.

FULLY AND CLEARLY DOCUMENTED, with comprehensive guide to program and game, and in-program HELP facility, and demonstration simulation.

SUPPLIED ON GOOD QUALITY C.12 CASSETTE WHICH WE WILL SWOP IF YOU HAVE ANY LOADING TROUBLE.

PRICE £9.00

including VAT & POSTAGE

COMPUTERCRAFT LTD

129 Newington Green Road

LONDON N1 4RA

Telephone: 01-226 0656

EXIDY SORCERER

in the
MIDLANDS
contact

Midland Microcomputers
Nottingham (0602) 298281
for all your hardware and
software requirements

ANADEx DP80000
£520 EX STOCK

Add £10 carriage 15% VAT
Cash with order

MICRODATA

58 High Street, Prescot,
Merseyside L34 6HQ
Tel: 051-426 7271

EPROM PROGRAMMING POSTAL SERVICE FOR 2708 and 2716

From your Hex listing: £9 + VAT (2708)
£18 + VAT (2716)

From your Master Prom: £2.50 + VAT
Editing at pro-rata rates

(Prices include p/p and assume you supply the device to be programmed, we can supply the device however at reasonable extra cost).

WRITE FOR FURTHER DETAILS TO:
Chromatec Video Products Ltd.,
10 Barley Mow Passage, Chiswick,
LONDON W4

0F53	C0	D4	LD (END+Lo)	Load "END+" Then,
0F55	60		XRE	using "EXOR" test
0F56	9C	F1	JNZ(LOOP)	for equality with
0F58	35	01	XPAH1, XAE	P1 register
0F5A	40	35	LDE, XPAH1	
0F5C	C0	CA	LD(END+Hi)	If equal jump to loop.
0F5E	60		XRE	
0F5F	9C	E8	JNZ(LOOP)	
0F61	B8	C4	DLD(LOOPCOUNT)	Decrement counter and
0F63	9C	D5	JNZ(REP)	escape on Zero Count.
0F65	C4, 00,	07	LDI, 0, CAS	RESET FLAG 1
0F68	3F		XPPC3	RETURN TO MONITOR

PROGRAMS

Keyword retrieval system

by Derrick Daines

How often do you spend hours searching for a magazine article, recipe or whatever? You just *know* it's around somewhere, but can't quite lay your hands on it. Well, if you're like me, it happens often. So often that I felt that a computerised magazine filing system was called for. The program that follows is exactly that — it enables you to store details of the articles or whatever and recover the salient facts by keying in important words. Provided that you have organised your literature (on the bookshelves, I mean) in some sensible order — by author, by volume or by subject perhaps — then hours of frustration will be avoided.

The program is, of course, written in BASIC, with the disc-operating system of my machine in mind — the SWTP 6800. I first made a short list of those computing files that I might need — articles on programming, hardware and new products — then realised that programming articles ought to be subdivided into Assembler language, BASIC and Pilot. The hardware file I also subdivided into general and those especially applicable to my own machine, the 6800. Each reader will have his own preferences and will be able to change the menu of lines 50-100 to suit. Similarly, the sub-menu headings of lines 1010 — 7000 will be altered. Notice that these are only the headings; the real sub-menu is at lines 250-280 and is the same for each.

On running the program therefore, one is presented with the main file menu of lines 10-120 and the appropriate file is opened on selection. The sub-menu is then presented, giving the choice of search, input or return to menu. Let's take the input first, since this is where we will all start. A dummy file is needed to kick off and without it you'll get an error message. I created the dummy files using the DOS BUILD command, naming each file but entering nothing more than a carriage return in each.

When we indicate that we want to enter new data, the appropriate file is opened for WRITE. The input data has three fields — (a) title, (b) index and (c) comment. The title field is not, perhaps, so obvious as it might seem. Many magazine articles have titles that convey little or nothing about the contents — and PCW has published its fair share of these. It is therefore necessary to enter an extended title devised by the user, designed to give this information. It is separated from the published title by a dash. This is important, since it is a

peculiarity of my DOS system (perhaps shared by others) that a comma is taken to be the end of a DATA statement. The result is that ANY use of the comma in ANY data-field string effectively truncates the field at that point. The comma is therefore verboten; hence the use of the dash.

The index field of course contains the information as to where the information is to be found — eg. PCW Jan. 1979 p.25 (Notice — no commas!).

Finally, the comment field is added as a further guide to article selection. As far as possible this should be objective comment, rather than the subjective 'Great program!' variety, since it will be found without any doubt that one's tastes and needs change as knowledge and experience is gained. Besides, the subjective comment rarely conveys information; the objective, "Needs 24K to run" does.

Finally it should be added that as written, any field can be up to 72 characters long, which is more than sufficient for most purposes.

The search loop is elegant and reveals the real power and purpose of the system. Suppose that my wife wants a recipe of say, soup made out of onions and has a vague remembrance that the one she wants included wine and breadcrumbs. She inserts her recipe disc into the machine, calls up the menu, and asks for a search and is told to input keywords (lines 410 — 480). She can tap in up to ten keywords and obviously would choose onion (return), wine (return), and breadcrumbs (return). The disk system swings into action. It searches every file title and prints out those file entries that have ALL the keywords in the title field (published or extended). Obviously, the more keywords typed in the smaller the number of displayed entries and of course if she has not been careful in her choice of keywords — or initially in her choice of extended title — it is possible that no entries are displayed, or unsuitable ones. Conversely, if I tapped in only one keyword — say transistors — it is possible that I might get several hundred displayed entries. It requires care, but is extremely useful. Going back to my wife's problem; if she remembered the onions and breadcrumbs but forgot the wine part, it would make no difference. The recipe that she wanted would be displayed along with all others that included onions and breadcrumbs.

The hardest and most time-consuming task of all is to create the

NORWICH

The computer store that puts you on the right road

Sales, Service and Software

Professional systems and home computers by CompuCorp, Commodore and Adler.

Commodore Software, Appointed stockist. Pet Soft Software

COME AND SEE THE PROFESSIONALS

SUMLOCK BONDAIN (EAST ANGLIA) LTD
32 PRINCE OF WALES ROAD
NORWICH
Tel NORWICH (0603) 26259



COMMODORE PET SPECIALISTS

We stock the Commodore range of equipment and have a large selection of high quality software to go with it.

We also have programming facilities and fast reliable maintenance support.

In stock is a selection of secondhand and ex. demonstration machines all guaranteed.

Give us a call first to see what we have to offer.

DAVINCI COMPUTERS LTD.
Tel: 01-202 9630
Classic Offices
Rear of Classic Cinema
Hendon Central
London NW4.

COMPUKIT & SUPERBOARD OWNERS

EXTRA MEMORY

Smart 2 is the first in a series of expansion units for your computer. SMART 2 gives 16K of RAM and 4K of ROM.

£129.95 for kit including 8K memory

£29.95 bare board

£59.95 8K RAM

£54.95 if bought with kit

50p postage & packing. VAT extra.

Order to, or S.A.E. for more details to:
Mike Dennis, Blackberries
Sheriffs Lench, Evesham, Worcs
Evesham 870841

SUPERBRAIN

Available now. Demonstrations on your premises. The best value available on the market in small business systems.

64K RAM
320K Dual Floppy
CP/M

£1950 plus VAT.

ENCOTEL SYSTEMS LTD
Tel: Upper Warlingham 5701
Telex: 896559

PROGRAMS

data files. There is no shirking this task; once the program has been created and tested, several evenings must be given over to entering the data — the carriage return finger gets quite numb! To speed things up a bit, I whisk through a dozen or so mags at once, inserting slips of paper in all those places where articles are to go into the same file. It all sounds rather tedious and probably is, but you'd be amazed how many articles I found that I had intended to read but forgot! Maybe that was why this aspect of the job took so long!

So — I now have a system that enables me to find any article within a few minutes and it gets plenty of work to do. Upkeep from now on is minimal. Whenever I get a computer magazine and have finished devouring it, I take it into the den and enter the file details —

this takes about five minutes. The mag then takes its place on the shelf with the rest and once a year or so I bind sets together.

Apart from the problem of making sure that each mag or book is in its correct place when I am not using it, there are two other small areas of worry. One is when any file gets too big, the disc is going to take a long time — several minutes — searching it all. The other is, what happens if I wish to delete an entry — perhaps preparatory to throwing a book away? In fact, this is going to require another small program that will solve both problems at once. The system will print out every entry in turn and ask for a decision from the user as to which of the new files the entry is to go to — or whether it is to be deleted. Perhaps if the editor agrees, this program can be published later.

```

• 0001 FOR X=1 TO 5:PRINT:NEXT X
• 0006 DIM A$(10)
• 0010 PRINT TAB(20); "COMPUTING FILE"
• 0020 PRINT TAB(20); "===== "
• 0030 PRINT "ON-GOING CATALOGUE OF LITERATURE"
• 0040 PRINT
• 0050 PRINT " 1 - COMPUTER PROGRAMS (ASSEMBLER)"
• 0060 PRINT " 2 - COMPUTER PROGRAMS (BASIC)"
• 0070 PRINT " 3 - COMPUTER PROGRAMS (PILOT)"
• 0080 PRINT " 4 - HARDWARE - 6800 SPECIFIC"
• 0090 PRINT " 5 - HARDWARE GENERAL"
• 0100 PRINT " 6 - NEW PRODUCTS"
• 0110 PRINT " 7 - GENERAL INTEREST"
• 0120 PRINT " 8 - FINISHED WITH PROGRAM"
• M. "
• 0130 X=0:GOSUB 200
• 0140 PRINT :PRINT:PRINT
• 0160 ON A GOTO 1000, 2000, 3000, 4000, 5000,
• 6000, 7000, 8000
• 0170 OPEN #1,F#
• 0175 IF A<=2 THEN 180
• 0177 ON A-2 GOTO 10, 8000
• 0180 ON A GOSUB 400, 8010
• 0190 GOTO 50
• 0200 PRINT :INPUT"          SELECT", A
• 0210 A=ABS(INT(A)): IF A=0 THEN 200
• 0220 IF A<X THEN 200
• 0230 RETURN
• 0240 PRINT
• 0250 PRINT " 1 - SEARCH"
• 0260 PRINT " 2 - INPUT NEW FILE DATA"
• 0270 PRINT " 3 - RETURN TO MENU"
• 0280 PRINT " 4 - END"
• 0290 X=4:GOSUB 200
• 0300 RETURN
• 0400 PRINT :PRINT:PRINT
• 0410 PRINT "GIVE KEYWORDS SEPARATED BY C
/R"

```

PROGRAMS

```

0420 PRINT "TO END INPUT OF KEYWORDS, TA
P C/R"
0460 PRINT :PRINT:FOR X=1 TO 10: INPUT A$(X)
0470 IF A$(X)=" " THEN 490
0480 NEXT X:PRINT "TOO MANY KEYWORDS. RE
-ENTER":GOTO 460
0490 READ #1,B$,C$,D$
0500 IF EOF(1)=1 THEN 600
0505 REM - THE FIRST INPUT WORD THAT DOE
S NOT MATCH, GO TO NEXT READ!
0510 T=LEN(B$):FOR G=1 TO X-1:L=LEN(A$(G))
0520 IF T<L THEN 490
0530 FOR H=1 TO T-L+1
0540 IF MID$(B$,H,L)<>A$(G) THEN 560
0550 GOTO 570
0560 NEXT H:GOTO 490
0565 REM - WORD MATCHES
0570 NEXT G
0575 REM - ALL INPUTS MATCH
0580 PRINT "TITLE: ";B$
0582 PRINT "INDEX: ";C$
0584 PRINT "COMMENT: ";D$
0586 PRINT
0590 GOTO 490
0600 PRINT :PRINT "END OF FILE"
0610 INPUT " SEARCH THIS FILE AGAIN",A$
0620 IF LEFT$(A$,1)<>"Y" THEN 640
0625 RESTORE #1
0630 PRINT " INPUT YOUR KEYWORD(S)":GOT
O 460
0640 CLOSE #1
0650 RETURN
1000 REM
1010 PRINT TAB(8);"COMPUTER PROGRAMS (AS
SEMBLER)"
1020 PRINT TAB(8);"=====
=====
1030 GOSUB 240
1040 F$="1.COMPASS.DAT"
1050 GOTO 170
2000 REM
2010 PRINT TAB(10);"COMPUTER PROGRAMS (B
ASIC)"
2020 PRINT TAB(10);"=====
=====
2030 GOSUB 240
2040 F$="1.COMBAS.DAT"
2050 GOTO 170
3000 REM
3010 PRINT TAB(10);"COMPUTER PROGRAMS (P
ILOT)"
3020 PRINT TAB(10);"=====
=====
3030 GOSUB 240
3040 F$="1.COMPIL.DAT"
3050 GOTO 170
4000 REM
4010 PRINT TAB(10);"HARDWARE - 6800 SPEC

```

MICROMART

APPLE & ITT 2020 BUSINESS SOFTWARE

Professionally written packages now available with comprehensive manuals, built-in validity checks, interactive enquiry facilities, user options, satisfying accountancy, Inland Revenue and Customs & Excise requirements. On diskette under DOS 3.2 in Applesoft with SPACE utility. Not adaptations. Written for Apple System. Support all printer interfaces. Sales, Purchases and General Ledgers £295-00 each. Manual only £3. Payroll £375. Manual only £4. General Ledger supports Incomplete Records, Job Costing, Branch and Consolidated Accounts, etc. General Ledger Applications Manual £10. Prices exclusive of V.A.T. From our shop or your nearest stockist.

COMPUTECH SYSTEMS

168, Finchley Road, London NW3,
Tel: 01-794 0202

Modata

30 ST. JOHNS ROAD
TUNBRIDGE WELLS
KENT

Telephone: Tunbridge Wells (0892) 41555

DIGITAL MICROSYSTEMS
LOW COST BUSINESS COMPUTERS

DSC-2	ONE TO 29 MEGABYTES DISK STORAGE
	64 Kbytes of Main Memory - STANDARD
HEX-29	Digital Research CP/M operating system - STANDARD
	TEXT PROCESSING, BASIC, COBOL, FORTRAN available
	32 TO 96 MEGABYTES DISK STORAGE
HEX-29	32 USER & 16 TASK capability - STANDARD
	Reentrant ASSEMBLER & BASIC - STANDARD
	Floppy disk based development system available

MODATA still need DEALERS in parts of U.K. and IRELAND

SOUTHAMPTON PET HIRE

Weekly charges:

8k (old £20 (new £23); 16k £27
32k £32; Printer £35; Floppy Disk:
£35

MICROCHESS and TIS WORK-BOOKS included charges may be offset against purchase.

Demonstration of large range of Commodore and Petsoft software.

Second hand PETs from £375

PANTAL cassette decks (with counter and audio) £65

Top quality TV modulator for PET (no streaking) £25

NEW. High precision 12 bit A/D converter, 4-channel, 3kHz, user Port version £248. Other versions to order.

All prices exclude VAT.

£50 free software with purchase of any computer, part exchange welcome.

SUPER-VISION

13 St James Road

Shirley

Southampton

Telephone (0703) 774023

After Hours (0703) 554488

MICROMART

PET EDITOR

Provides full creation and editing of symbolic text or data files, etc, using:

12 POWERFUL COMMANDS including - CREATE, EDIT, FIND, REPLACE, INSERT, MOVE, TAB, etc.

(SAE for full software list.)

On cassette

**CIRCLE
SOFTWARE** £20.00
+ VAT
(State old/new ROM + size)

(State old/new ROM + size)

33 Restrop View, Purton, Swindon,
Wilts. SN5 9DG.

SHARP MZ-80K
from £520 plus VAT

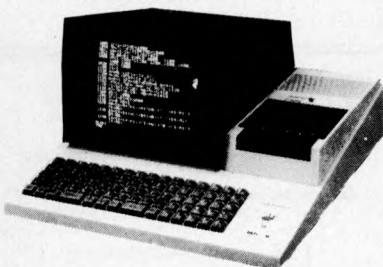

PET HIRE from £4.25/day

Essex Computer Services
10 Grafton Road, Canvey Island Essex.
Tel: Canvey Island (03743) 61663

SIGMA SYSTEMS

PETs

+

SHARP MZ-80s
(THE NEW MICRO)

+

HEWLETT-PACKARD
HP-41Cs

+

COMPUTER BOOKS

SIGMA SYSTEMS
54 PARK PLACE
CARDIFF 21515

**54 PARK PLACE
CARDIFF 21515**

LOOKING FOR RENTAL
PREMISES IN THE
WEST MIDLANDS?

Up to 2,000 sq.ft. available in
Department Store.

For details contact:
O.M. ELDRIDGE
F.W. Cook Ltd.
Cooks of Dudley,
High Street, Dudley,
West Midlands DY1 1QH
Tel: Dudley 53724/54520

PROGRAMS

```
• IFIC"
• 4020 PRINT TAB(10); "=====
• =====
• 4030 GOSUB 240
• 4040 F$="1. HARD6800. DAT"
• 4050 GOTO 170
• 5000 REM
• 5010 PRINT TAB(10); "HARDWARE GENERAL"
• 5020 PRINT TAB(10); "=====
• 5030 GOSUB 240
• 5040 F$="1. GENHARD. DAT"
• 5050 GOTO 170
• 6000 PRINT TAB(10); "NEW PRODUCTS"
• 6010 PRINT TAB(10); "=====
• 6020 GOSUB 240
• 6040 F$="1. NEWPROD. DAT"
• 6050 GOTO 170
• 7000 PRINT TAB(10); "GENERAL INTEREST"
• 7010 PRINT TAB(10); "=====
• 7020 GOSUB 240
• 7040 F$="1. GENINT. DAT"
• 7050 GOTO 170
• 8000 END
• 8010 REM - INPUT NEW DATA
• 8020 PRINT :PRINT:PRINT
• 8025 OPEN #2, 1 TEMP. SCR
• 8030 SCRATCH #2
• 8035 READ #1, B$, C$, D$
• 8040 IF EOF(1) THEN 8080
• 8045 WRITE #2, B$, C$, D$
• 8050 GOTO 8035
• 8080 PRINT "TITLE - THE FIELD LOOKED AT
• DURING A SEARCH. "
• 8090 PRINT "INDEX - WHERE THE ARTICLE MA
• Y BE FOUND. "
• 8095 PRINT "COMMENT - ELABORATION OF TIT
• LE OR ADDITIONAL INFORMATION. "
• 8100 PRINT :PRINT: PRINT"INPUT YOUR DATA
• -"
• 8110 INPUT "TITLE", B$
• 8120 INPUT "INDEX", C$
• 8130 INPUT "COMMENT", D$
• 8140 PRINT :PRINT: INPUT "ENTRIES OK", A$
• 8150 IF LEFT$(A$, 1)="N" THEN 8100
• 8160 WRITE #2, B$, C$, D$
• 8170 PRINT :INPUT" FILED. MORE ENTR
• IES", A$
• 8180 IF LEFT$(A$, 1)="Y" THEN 8100
• 8190 CLOSE #1, #2: KILL F$
• 8200 RENAME TEMP. SCR. 1 F$
• 8210 RETURN
```

Scrolled message for MK14

by Mark Franklin

The following program will allow the MK14 to display messages, stored backwards in memory, in a scrolled format. The data for the message at 0B00 (extra RAM), is arranged in eight byte blocks. The maximum number of blocks (or lines) is FF₁₆ (255₁₀). The byte which determines the time each line is displayed is stored at 0F19. The

number of lines is stored at 0F50. Note: The byte at 0F most also be stored at 0F5A, otherwise strange things will occur. The byte at 0F1A determines where the data starts in RAM, ie. 0B00 (0F1A 00) 0B08 (0F1A 08)

PROGRAMS

• 0F19 XX delay	0F3A 9CF8	•
• 0F1A XX position	0F3C B81E	•
• 0F1B XX number of lines	0F3E 9CE7	•
• 0F1C C0FE	0F40 B819	•
• 0F1E C838	0F42 9CE3	•
• 0F20 C40B	0F44 C0D4	•
• 0F22 36	0F46 C813	•
• 0F23 C0F6	0F48 02	•
• 0F25 C802	0F49 C0DE	•
• 0F27 C400	0F4B F408	•
• 0F29 32	0F4D C82A	•
• 0F2A C40D	0F4F 8FZZ	•
• 0F2C 35	0F51 B805	•
• 0F2DC400	0F53 9CD2	•
• 0F2F 31	0F55 3F, (90C5 [to loop])	•
• 0F30 C408	0F57 00	•
• 0F32 C825	0F58 00 } counters	•
• 0F34 C601	0F59 00	•
• 0F36 C201	0F5A XX delay	•
• 0F38 B81F		•

FUN & GAMES

Kaleidoscope

BY R G Hall

This program, written in PET BASIC, creates an ever changing pattern on the screen like a kaleidoscope, but in four parts.

The selected character is POKEd on to the screen in sixteen places, but lines 110-140 may choose to do a bit of

clearing so as not to fill the screen completely.

Note: Line 50 PRINT "☐" may be used to clear the screen RND(TI) makes use of the PET's clock to randomize the pattern. (Try RND(1) etc.).

```

• 10 REM 4 SQUARE
• 20 REM BY R G HALL 1979
• 50 PRINTCHR*(147):REM CLEAR SCREEN
• 60 REM SELECT POSITIONS
• 70 A=INT(RND(TI)*10)
• 80 B=INT(RND(TI)* 6)*40
• 90 REM SELECT PRINT CHAR.
• 100 C=INT(RND(TI)*255)
• 110 REM SELECT PRINT OR SPACE
• 120 R=INT(RND(TI)*10)
• 130 IFR>5THEN 160
• 140 C=32
• 150 REM POKE TO SCREEN
• 160 S=33018:T=33037:U=33458:V=33477
• 170 POKES-A-B,C:POKET-A-B,C:POKEU-A-B,C
• :POKEV-A-B,C
• 180 POKES+A-B,C:POKET+A-B,C:POKEU+A-B,C
• :POKEV+A-B,C
• 190 POKES-A+B,C:POKET-A+B,C:POKEU-A+B,C
• :POKEV-A+B,C
• 200 POKES+A+B,C:POKET+A+B,C:POKEU+A+B,C
• :POKEV+A+B,C
• 210 GOTO 70
• READY.
    
```

BELLS & WHISTLES

Efficient character storage

by David Tucker

In computing it is very often desirable to pack as many characters as possible into a given area of memory.

The usual method of holding text is to encode the text into 8 bit ASCII and store one character per byte. Thus there

MICROMART

NEW

MICROTYPE

SERIES 80

MICROCOMPUTER CASE

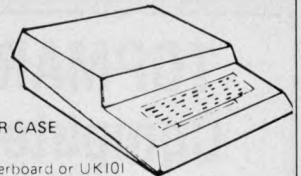

Ready Cut for Superboard or UK101
Complete with screws and instructions.
Also available with uncut keyboard for homebrew enthusiasts. Produced in strong, black ABS plastic. Please state type when ordering.

ONLY £17.50 + VAT Post and packing inclusive.

Send Cheque or Postal Orders to

Microtype, PO Box 104, Hemel Hempstead,

Herts HP2 7QZ SAE for Details



12 BRANDED DIGITAL QUALITY CASSETTES
With library box and index card 10 for 38p ea + VAT
Send £5.40 includes 1180 and VAT

Personal Computer

requires an

ADDITIONAL EDITOR

The position is a demanding one and we are looking for candidates with proven skills in editorial management, sub-editing, commissioning contributors and a real interest in microcomputing.

The successful applicant will work with an existing team in a small publishing house in the West End of London. The post calls for tenacity and the ability to remain calm and constructive while working under considerable pressure.

Salary will be depend on previous experience. All applications will be treated in confidence and should contain relevant career details.

Please address your application to:

Editorship Applications, Personal Computer World Magazine, 14 Rathbone Place, London W1P 1DE. Telephone: 01-637 7991.

SYSTEMSCRIBE

SMALL SYSTEMS SOFTWARE

Programming is a logical procedure: logical programming begins with coding sheets. SYSTEMSCRIBE Coding Sheets, designed to be useable with most languages, are ideal for the microcomputer programmer (whoever does the keying-in will appreciate them too!) Pads of 50 sheets: 25 x 80 format. 3 pads for £4.50 (including VAT and postage).

SYSTEMSCRIBE LIMITED
62 Daws Heath Road, Thundersley, Benfleet
Essex SS7 2TA

DATA + =

TO YOUR REQUIREMENTS
BUY OR LEASE

CENTRONICS 730
NOW IN STOCK
£525 + VAT

DATAPLUS, 67 BRIDGE STREET,
MANCHESTER M3 3BQ.

TELEPHONE: 061-832 3265
A division of Norman Green (Photo) Ltd

TOPMARK Computers

dedicated to
APPLE II



Simply the best!

Full details from Tom Piercy on
Huntingdon (0480) 212563

COMPUCOLOR II

Pay for mod 3:- get mod 4

Pay for mod 4:- get mod 5

PET

Up to £100 free software
with New PET

4k to 8k conversion £79*
8k to 32k (from) £210*

APPLE

At least £75 free software
with New Apple

TEXAS

T199/4 Colour, Music & Graphics, P.O.A.
SHARP

Up to £75 free software with new
MZ - 80K

PET SOFT; GEM SOFT; LANDSLER
PROGRAMS

*TAX & CARR. FREE *Excluding VAT

TELETEXT CONVERTER

WITH REMOTE, ONLY £199.95

MOST MAKES

SOLD/BOUGHT/CONSTRUCTED

MANY USED BARGAINS IN STOCK

OPTELCO

RALEIGH (0268) 774089 (up to 8p.m.!)

**MICROS BOUGHT,
SOLD OR EXCHANGED.**

MICROHIRE

SOME BELOW £14/WEEK
MONEY BACK ON PURCHASE.
FREE DELIVERY & COLLECTION
IN LONDON.

SMALL CHARGE OTHERWISE.
APPLE, PETS, SOCERER, HORIZON,
PRINTERS, FLOPPY DRIVES.

SALE NOW ON

APPLE 32K ONLY £700

(CENTRONICS T/F 779) £700

HORIZON 32K D/D £1,200

PAPER TIGER £540

COMPLETE CHALLENGER SYSTEM

WITH 2 DISK DRIVES ONLY

£900

PET 8K ONLY £400

APPLE DISK DRIVE ONLY £340

PHONE US FOR OUR LATEST OFFERS

MONDAY - SUNDAY

BEST TIME EVENINGS

01-368 9002

BELLS & WHISTLES

are 256 possible different ASCII codes that can be stored in any particular byte.

Very often however the only characters of interest are A to Z, 0 to 9, space and perhaps a couple of punctuation marks.

It so happens that if we take a set of 40 characters we can encode them in such a way that three characters can be stored in 16 bits (2 bytes), thus increasing the storage capacity of a given area of memory by 30%.

We do this by treating the three characters as if they were digits of a number to the base 40.

Suppose a=1, b=2, c=3

Then ABC = 3x40x40+2x40+1 = 4881

The number 4881 could be stored in a 16 bit word.

The maximum value would be 39x40x40+39x40+39 = 63999.

This is less than 65535 (the maximum 16 bit number).

The two subroutines presented here are written in Z80 assembler code although the principles outlined can be applied to any machine.

The ENCODE subroutine takes a three byte ASCII string whose address is in the BC register pair and returns the encoded RADIX-40 characters in the HL register pair.

The DECODE subroutine takes the three RADIX-40 characters in the HL register pair and returns a three byte

ASCII string starting at the address contained in BC.

How it works:

The ENCODE subroutine first clears the HL register pair then calls the subroutine FIND which locates the character pointed to by BC and returns its number from the end of the TABLE in register A. BC is then incremented to point to the next character.

DE is loaded with 1600 (40x40) and the subroutine MULT is then called. This subroutine multiplies the contents of register A and adds the result to register pair HL.

The process is repeated for the other two characters with DE set to 40 then 1.

The three characters have now been encoded.

The DECODE subroutine performs the inverse operation to ENCODE.

The register pair DE is first loaded with 1600 then the subroutine TRANS is called. This subroutine performs an integer division of HL by DE leaving the result in register A and the remainder in HL. It then locates the relevant character in the TABLE and transfers it to the location pointed at by BC and finally increments BC. The whole process is repeated with DE set to 40 then 1.

```

0000      0010      ORG  $0D00
0020      ;BC POINTS TO A
0030      ; 3 CHARACTER STRING
0040      ; ON RETURN
0050      ; HL CONTAINS RADIX-40
0060 ENCODE LD  HL,0 ;CLEAR HL
0070      CALL FIND ;1ST CHARACTER
0080      LD  DE,1600 ;40*40
0090      CALL MULT ;DE*A
0100      CALL FIND ; 2ND CHARACTER
0110      LD  DE,40
0120      CALL MULT
0130      CALL FIND ; 3RD CHARACTER
0140      LD  DE,1
0150      CALL MULT
0160      RET  ;FINISH
0170      ;
0180 FIND  LD  A,(BC) ;GET CHARACTER
0190      INC BC ;POINT TO NEXT
0200      PUSH BC ;SAVE
0210      PUSH HL ; ON STACK
0220      LD  RC,40 ;TABLE LENGTH
0230      LD  HL,TABLE
0240      CPIR ;FIND CHARACTER
0250      LD  A,C ;GET NUMBER
0260      POP HL
0270      POP RC
0280      RET
0290      ;
0300 MULT AND A ;SET CONDITION
0310      ; CODES
0320      RET Z ; FINISH IF 0
0330      ADD HL,DE
0340      DEC A ;DEC COUNT
0350      JR  MULT ;ROUND WE GO
0380 ;HL CONTAINS RADIX-40
0390 ; BC POINTS TO RESULT BUFFER
0400 DECODE LD  DE,1600 ;40*40
0410      CALL TRANS ;1ST CHARACTER
0420      LD  DE,40
0430      CALL TRANS ;2ND
0440      LD  DE,1
0450      CALL TRANS ;3RD
0460      RET  ;FINISH
0470      ;
0480      ;
    
```

BELLS & WHISTLES

• 0D48 AF	0490 TRANS	XOR	A ;CLR A	•
0D49 ED52	0500 TRANSI	SBC	HL,DE ;SUBTRACT	•
• 0D4B 3803	0510	JR	C DONE ;JUMP IF OVERFLOW	•
0D4D 3C	0520	INC	A ;INC COUNTER	•
0D4E 18F9	0530	JR	TRANSI ;ROUND WE GO	•
• 0D50 19	0540 DONE	ADD	HL,DE ;RECOVER VALUE	•
0D51 E5	0550	PUSH	HL	•
• 0D52 21870D	0560	LD	HL,TABEND ;END OF TABLE	•
0D55 5F	0570	LD	E,A ;GET A IN DE	•
• 0D56 1600	0580	LD	D,0	•
0D58 ED52	0590	SBC	HL,DE ;GET ADDRESS	•
• 0D5A 7E	0600	LD	A,(HL) ; GET CHARACTER	•
0D5B 02	0610	LD	(BC),A ;STORE	•
• 0D5C 03	0620	INC	BC ;POINT TO NEXT POSITION	•
0D5D E1	0630	POP	HL	•
• 0D5E C9	0640	RET		•
	0650 ;			•
	0660 ;			•
• 0D5F 20414243	0670	TABLE	DEFM / ABC/	•
0D63 44454647	0680		DEFM /DEFG/	•
• 0D67 48494A4B	0690		DEFM /HIJK/	•
0D6B 4C4D4E4F	0700		DEFM /LMNO/	•
• 0D6F 50515253	0710		DEFM /PQRS/	•
0D73 54555657	0720		DEFM /TUVW/	•
• 0D77 58595A31	0730		DEFM /XYZ1/	•
0D7B 32333435	0740		DEFM /2345/	•
• 0D7F 36373839	0750		DEFM /6789/	•
0D83 302E2C3F	0760		DEFM /0.,?/	•
• 0D87 00	0770	TABEND	NOP	•

LEISURE LINES

With J. J. Clessa

The Search for the smallest palindrome with an even number of digits attracted over forty replies. As usual the complaint was "Too Easy", although I didn't receive any analytical solutions to support this view. Instead I had the usual collection of program listings for computers, ranging from main frames, through micros down to programmable calculators. I'll not be publishing any of them, but suffice to say the correct answer is 698896 — which is the square of 836.

I made a draw for the winning entry using Dave Tebbutt's biased random number generator — which should by rights have awarded the prize to one of his relatives. However, it seems to have hit a bug this time. . . unless Mr P. Albericci of Bristol turns out to be a very distant cousin!

Congratulations Mr Albericci. . . a Paper Mate pen and pencil set will be winging its way to you c/o the PO — let me know if it ever arrives. Meanwhile it's time to think of more diabolical problems — try this one for size:

QUICKIE

Actually, not so much a problem, more an outrage, you have 30 seconds to complete the following "Irish" crossword. Remember not to pull any punches. . .

CLUES ACROSS

1. Hit hard
2. A party drink
3. Often in seaside shows
4. Use for making holes
5. What conductors do to tickets

CLUES DOWN

1. Vegetables
2. Female sheep
3. They lay eggs
4. Often sailed on
5. Dropped by Cockneys

	1	2	3	4	5
1					
2					
3					
4					
5					

PRIZE PUZZLE

This one is quite feasibly done by logical deduction — you could, however, computerise your efforts.

A child's cube has coloured faces. Five colours are possible — red, green, blue, yellow and orange. Three views of the same cube are shown here, and in each of the views the colour on the bottom face of the cube is not repeated on any other face. Which colour occurs twice on the cube?

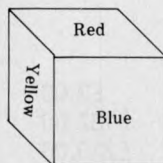
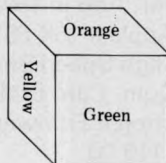
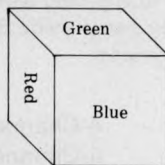

Answers please on a postcard to Puzzle No. 7, Personal Computer World, 14 Rathbone Place, London W1P 1DE. All solutions must arrive by March 14th latest.

PRIZE FOR THIS MONTH

Support our authors. . . this month I'm giving away a £10 W.H. Smiths book voucher to the sender of the first correct card out of the bag — good luck!

MICROMART

APPLE and PET SYSTEMS
in DUBLIN

* Come and try these fine computers
in our showrooms

Sensible Software for Apple

- * Sales, Creditors Ledgers; Financial Modelling
- * Educational systems in Maths, Physics, Geography, Commerce.

SOFTECH

SOFTECH Ltd., 51 Lr Camden St.,
Dublin 2, Ireland. Phone Dublin 784739

Vets for Pets

Anita Electronic Services (London) Ltd.
are specialists in the repair and service of
Commodore Pets.

We offer a fast on-site service, or alternatively repairs can be carried out at our workshops should you wish to bring in your Pet.

Pet maintenance contracts are available at very competitive prices. Trade inquiries welcomed.

For further information, tel or write to:

John Meade
Anita Electronic Services
15 Clerkenwell Close, London EC1
01-253 2444

We also specialise in the repair of all makes of office equipment.

µHex EPROM PROGRAMMERS

426 2508/2708/2758/2516/2716
Dual and Single supply Eproms, £95

416 2704/2708/2716 Dual only. £65

480 2704/2708 Kit £35. Built £40.

All programmers require only standard power supplies.

The 426 & 416 are cased and have push-button selection.

Program any length block into the Eprom. Software included. Range covers Z80, 8080, 6800 and 6500. State machine.

PIO, PIA INTERFACE MODULES

Available for Z80/8080 and 6800/6500.

Prices include carriage. Please add VAT. SAE for further product information.

MICROHEX COMPUTERS

2 STUDLEY RISE, TROWBRIDGE, WILTS.

To advertise in
MICROMART

Please ring Jacquie Hancock
on 01-631 1682



NewBear Books



WE HAVE 397 TITLES IN STOCK, SEND FOR COMPLETE LIST.

This is our new book shop,
First Floor Offices, Tivoli Centre
Coventry Rd., Birmingham
Telephone: 021 707 7170

GAMES

Chess & Computer	D. Levy	£ 7.16
Chess Skill in Man and Machine	P. Frey	£11.84
32 Basic Programs for the Pet		£ 9.95
Game Playing with Computers	D. Spencer	£10.20
Basic Computer Games	D. Ahl	£ 5.50
Star Ship Simulation		£ 5.10
Game Playing with Basic	D. Spencer	£ 4.10
Sargon	Spracklen	£ 9.50

BASIC

Learning Basic Fast	De Rossi	£ 6.30
Basic Basic	J. S. Coan	£ 5.00
Advanced Basic	J. S. Coan	£ 5.50
Illustrated Basic	D. Alcock	£ 2.25
Basic with Business Applications	Hayden	£ 8.40
Introduction to Basic	J. Morton	£ 6.50
The Basic Handbook	Lien	£11.00

COBOL

Cobol Programming	Nickerson	£ 6.95
Learning Cobol Fast	De Rossi	£ 6.20
Cobol with Style	Hayden	£ 4.20
Reducing Cobol Complexity	Mc Clue	£11.30

PASCAL

Pascal: User Manual and Report	Springer-Verlag	£ 5.52
Problem Solving Using Pascal	Springer-Verlag	£ 7.84
Programming in Pascal	P. Grogono	£ 7.50
A Practical Intro. to Pascal	A. Addyman	£ 3.50
An Introduction to Programming and Problem Solving with Pascal	Schneider	£ 9.50
Introduction to Pascal	J. Welsh & J. Elder	£ 6.95

FORTRAN

Elementary Computer Programming in Fortran IV	Boguslausky	£ 6.30
--	-----------------------	--------

PROGRAMMING

Chemistry with a Computer	P. A. Cauchon	£ 7.96
Seminumerical Algorithms	Knuth	£17.85
Fundamental Algorithms	Knuth	£17.85
Assembly Level Programming for Small Computers	W. J. Weller	£12.50
Sorting & Searching	Knuth	£17.85
Top-Down Structured Programming Techniques	McGowan	£12.50
The Design of Well Structured and Correct Programs	Alagic & Arbib	£10.00
Computer Mathematics		£ 8.58
Basic Principles of Data Processing Fundamentals of Computer Algorithms	Saxon/Steyer Horowitz/Sahni	£ 7.75 £15.00
Computer Approach to Introductory College Mathematics	Scalzo	£11.30
Computer Input Design	Woolridge	£ 8.85
Computer Output Design	Woolridge	£ 9.70
How to Program Micro's	Barden	£ 6.55

CREDIT SALES (Minimum £10), Access and Barclaycard
Welcome. "BY RETURN ORDER SERVICE"

CALLERS AND MAIL ORDER: 40 Bartholomew Street, Newbury, Berks. Tel: 0635 30505
CALLERS ONLY: 220-222 Stockport Road, Cheadle Heath, Stockport Tel: 061 491 2290

M I C R O C O N T R O L

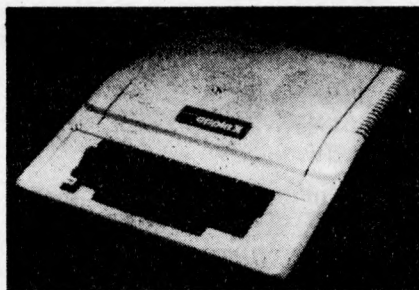

— THE INTERFACE EXPERTS

224 EDGWARE ROAD
LONDON W2
Tel 01-402 8842

MICRO CONTROL have been building specialised hardware and writing software, since Apple first came into the country. We can interface your Apple to *anything* with a custom designed card for a reasonable price. We can also provide Business Systems for Apple II and Micro Star to your requirements.

Centronics Printer Card £132.00

Apple disk drive £355.00
with controller crd £398.00

Micro Hush Printer
+ Apple Interface £266.00

Thermal paperoll for Micro Hush £2.00

10in b/w monitor £132.00

12in b/w monitor £210.00

Apple Pascal £289.00

MicroStar £4,950.00

Printers VDU's ITT Apples Software & one-off's P.O.A.

Colour board for Apple. Have your text in colour! Clean Lo-res/Hi-Res hires colours £147.00

Micro Con. Real Time Clock. Date/Hr/Minute £90.00

8-Channel Mains Controller £140.00

4-Channel Mains Dimmer £175.00

COMING SHORTLY:— Colour for PET and TRS 80

4-Channel A/D cards 12-bit £174.00; 8-bit £116.00

4-Channel D/A 12-bit £149.00; 8-bit £110.00

16K Add In 150ns £58.00

Apple II 16K £810.00

High Speed Serial Card £110.00.

Com. Card £140.00

Integer Firmware Card (inc. Mini-Assembler)

£110.00

Symtec light pen (for Apple) £165.00.

Apple Voice recognition Card £165.00.

Micro Products Eprom burner £140.00.

Box of 10 diskettes £30.00.

Buy here at discount prices!

Save money.

☆ Full after-sales service in our own workshops ☆ One year guarantee on all machines

Up to 1.6Mb for PET!

and 'on-line' with the Computhink Disc System

* Allows powerful business programmes using 16 Extra BASIC commands. * Easy to connect and use - plugs directly into 16/32K PETs, detailed manual supplied. * Simple startup (no difficult procedures to remember) as Disc Op. System in ROM. * Ready to run - useful programmes supplied free; full set of professionally written business packages available - Sales and Purchase Ledger, Stock Control, Payroll etc.. * Real-Time processing, Engineering and Commercial boundaries overcome with full language support - Business BASIC, Assembler, FORTRAN, COBOL, PASCAL, FORTH, FIFTH, PLM, PILOT & CESIL.

24K Memory expansion with dual disc for old ROM 8K PET £275
for new ROM 8K PET £320

Basic 400K dual disc system

only **£840**

800K £1,095
1.6 Mb £2,190

Credit terms available

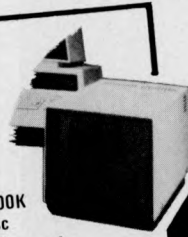

The only 16k complete computer for under £400

keyboard, computer, power supply, UHF modulator and all cables to plug into your own TV set and cassette recorder and go!!

16K of user RAM for decent size programmes and data, sophisticated level II microsoft basic. Fully converted to UK standard including frame sync. frequency (no wobbly display). Tandy don't do this! Complete with level I and level II programming manuals. What more could you ask?



£399

Extra numerical keypad **£33.95**
Expansion interface complete with 32K RAM **£299**

This lot must be today's best buy!

Get into print this easy way!

Fast! Immaculate! Silent!

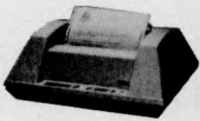

Anadex DP 8000 dot-matrix printer

*Speedy 112 ch/s bidir. * Fits A4 page - up to 80 cols. * Up to 4 copies. * Precision form-filling with sprocket feed. * Special headings using double-width chars. * Modern paper format to match A4 filing systems. * Other paper sizes with adj. sprocket. * Full punctuation, U/L case, £ sign, 96-ch. set. * Reliable - strongly built, 100 M.ch. head.

Knock down price!

£499

Interfaces - Pet £45 Ohio £10
TRS-80 £12 Sorcerer £6
Apple £69

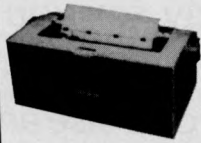

IBM golfball printer ideal for word-processing

* Forget expensive Spin-Wheel printers - the Golfball produces equal quality at up to 15 ch. per sec. * Match various typewriter styles with IBM interchangeable heads. * Completely reliable - each machine rebuilt by IBM trained engineers and fully guaranteed. * Precision form-filling possible with 15 in. pin-feed platen.

Limited supply!

£595

Interfaces - Pet £45 Ohio £10
TRS-80 £12 Sorcerer £6
Apple £69

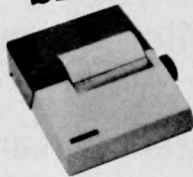

Trendcom 100 thermal printer

* Stop disturbing others with noisy printout! * Neat, clear, 96-ch. set, U/L case & symbols. * Matches Pet/Apple line lengths. * Fast, 40 ch/s bidir. * Reliable - robust - only two driven parts. * Plug in and go, built in PSU, detailed manual. * Thermal paper 4 1/2 in wide x 80 ft, less expensive than electro-sensitive paper.

A snip!

£249

Interfaces - Pet £45 Ohio £10
TRS-80 £12 Sorcerer £6
Apple £45

While stocks last

Leasing available to companies



PET 2001-8N (8K RAM New large keyboard)

£469

2001 - 16N (16K RAM and new large keyboard) **£590**
2001 - 32N (32K RAM and new large keyboard) **£690**
External cassette deck, suitable for all Pets **£53**
CBM dual drive mini floppy **£745**
CBM tractor feed printer with Pet graphics **£605**

You can afford to start computing now! - with the Ohio CI-P

As imported, fully tested, complete with 4K RAM, but unconverted to UK std. (conversion instructions supplied).

£199

Add £24 for converted model. Extra 4K RAM £39.

* Powerful programming possible - 6502 processor, fast 8K Microsoft floating-point BASIC (easy to learn). Superior utilities, 53 key key-board, giving upper and lower case, user-definable keys, gaming and graphics chs. Ultra-fast and powerful machine code from keyboard.

* No intricate soldering or metal work. Computer supplied assembled in ready-made case. * Reasonable sized programmes in 4K RAM. * Expandable to 24K RAM in case, drives discs, printer; available items include Assembler/Editor and Extended Monitor. * Programme interchangeability/reliability - Kansas City tape interface. * Save programmes on own cassette recorder - all cables supplied.

- at a lower price than equivalent kits!

COMPUTERAMA

LTD.

Tel: Bath (0225) 28819

Your dealer for Bath, Bristol and S.W.

Computerama Ltd.
Harpers Kensington
Showrooms
London Rd. Bath, Avon

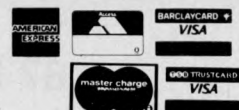

Credit card orders accepted by telephone for immediate despatch.

Please add £10 Securicor delivery on computers etc plus 15% VAT on all prices

PCW/3

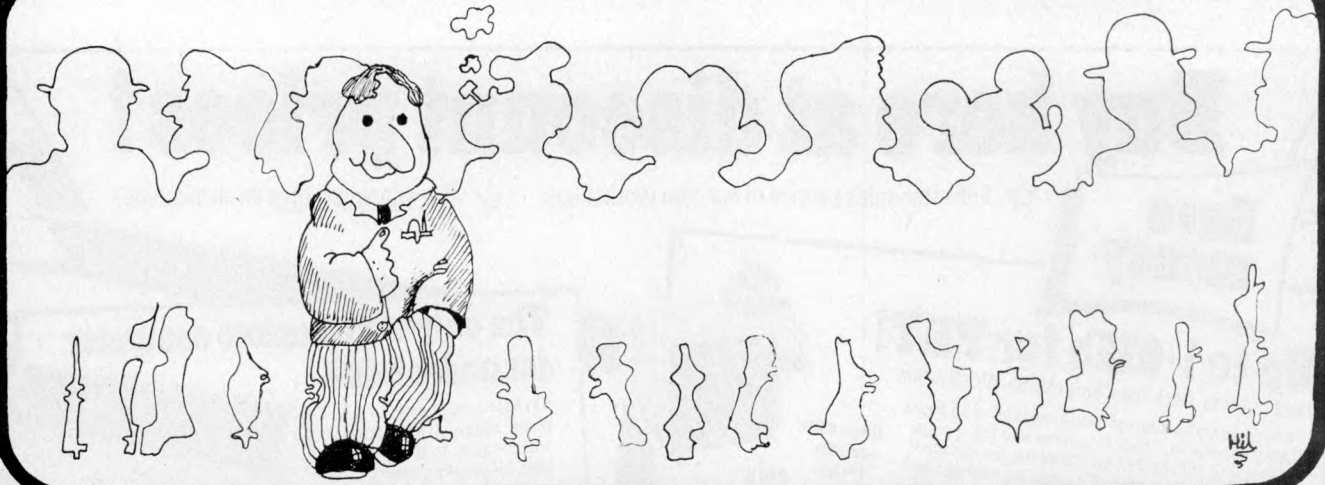

You stand out in a crowd – and we know it.

Your business is not exactly the same as any other and neither are its problems. Any solutions are probably unique and must be tailored exactly for you.

You know your business better than anyone else and any system designed should use your knowledge. The micro-computer specialist should show you how to use the computer to meet your business requirements.

You should be able to get the micro-computer which best suits your business. It should be chosen after your requirements are specified.

You and your staff have a right to know all about YOUR system, including helping to program it if you want to. Training is your right – not an additional service.

If microcomputers cannot satisfy your business needs, you want to know – you don't want false promises.

**67 Nova Road, Croydon, Surrey CR0 2TN.
Telephone: 01-688 6013**



TOMORROW TODAY

at
Birmingham Computer Centre

Commodore official distributors



3016, 3032, 3008 PETS
The reliable value for money system with after sales support, instruction and training facilities and a wide range of programmes.

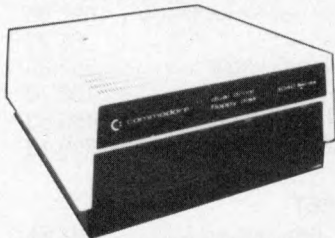

3040 DUAL DRIVE FLOPPY DISC
The latest in disc technology. Low cost with reliable data transfer.

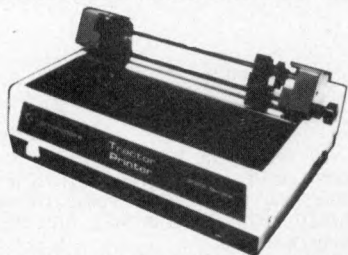

3022 PROFESSIONAL PRINTER
The high specification printer. Prints all PET characters onto paper and accepts labels, printed forms, cheques etc.



Apple authorised distributors
The sophisticated quality system with a reputation for advanced design and innovation.

**Camden Electronics, First Floor,
462 Coventry Road, Small Heath,
Birmingham B10 0UG.
Telephone 021 773 8240**

Open Mon.-Sat. 9.30-6.00 p.m.

A MEMBER OF THE COMPUTER RETAILERS ASSOCIATION

£39.50*

**Professional
ASCII Keyboards**



MODEL KB 756

**FULLY ASSEMBLED & TESTED
CASE AVAILABLE**

Accessories Available include:—

Edge Connector	KB15P	£1.95*
Numeric Key Pad	KB710	£7.50*
Plastic Case (Black)	KB701	£12.75*
DC to DC Converter	DC512	£5.00*

* U.K. Orders add 15% VAT on Order total.

FULL DATA SHEET ON REQUEST

Citadel Products Limited.

Dept. PCW 50 High Street, Edgware,
Middlesex HA8 7EP. Telephone 01-951 1848

**CARTER
KEYBOARDS**

You've heard about it
Read about it — HERE IT IS

AVAILABLE EX-STOCK
COMPLETE KIT AS PER
MANUFACTURER'S SPECIFICATION

With provision for 8K on board expansion. Excludes 4118 x8+

INCLUDES FREE 16K EXPANSION

VALUE £140 includes ALL parts with every kit

NASCOM-2
ON DEMONSTRATION NOW

£295 +15% WITH
VAT FREE
16K EXPANSION WORTH £140

AVAILABLE ONLY FROM US ON THE COUPON BELOW

OPTIONAL EXTRAS
**3 AMP POWER
SUPPLY** VAT 15%
£29.50 Post £1.50
For NASCOM-2

8 OFF 4118*
For NASCOM-2
PURChasers
£80 Early
Delivery

RS232 COMPATIBLE

80 COLUMN PRINTER brand new

List price £550. If sent by carrier £5 extra

OUR PRICE
£325 + VAT
15%

FULL MANUFACTURER'S WARRANTY — DON'T DELAY. ORDER TODAY

Please send me my **NASCOM-2 KIT** with the **FREE 16K EXPANSION**
for **£295 + VAT.**

I enclose remittance

to cover

Name & Address

Also in stock NASCOM-1 • ELF • TRS80 as previously advertised



HENRY'S

Computer Kit Division
404 Edgware Road, London, W2, England
01-402 6822





XITAN SYSTEMS

*LOOK AT THESE
NEW PRICES*

CROMEMCO SYSTEM 3

£4,054.00 for this system with vdu.

The ideal business system. System includes a full 64K fast RAM, dual full-size floppies (Persci 277), RS232 interface/20mamp loop for console device, parallel printer port (Centronics/Anadex compatible), 21 slots for expansion, Lear Siesler 24 lines or 80 chars vdu, and ... CROMEMCO's CDOS operating system with their 14 digit BCD extended disk Basic — ideal for those accurate large numbers required by successful businesses. CDOS is CP/M functionally equivalent, with many extra facilities. Optional extras from Xitan include Fortran, Cobol, Text Formatting, Z-80 macro-relocating assembler and DBMS at £59.00 each. CIS interactive screen handling Cobol at £425.00 (recommended to serious business users), Cromemco S100 boards, CP/M (we are an authorised oem distributor of Digital Research's CP/M) for the System 3, Wordmaster, Wordstar, Supersort, and CPM374X utilities.



COMING SOON! ... Full 7-terminal multi-user operating system from Cromemco for System 3 users. Up to 48K per user, all running independently. This operating system has to be seen to be believed. It will run any of the Cromemco provided and supported software packages, in any combination. Features include partition rescue facilities, allocating more memory to users, real-time clock for time/date stamping of jobs and disk queueing techniques. Buy your System 3 now, expand later as you need it.

S100 BRITISH COLOUR BOARD

We are proud to offer the first BRITISH S100 Colour board. Manufactured by a local Southampton company — Hi-tech, we can thoroughly recommend this product. Features include true PAL colour generation for high-definition on your television or colour monitor, 15+ colours and black/white with 6 additional grey scales, 24 lines with 40 characters per line, with standard character set plus 44 numbers and symbols, and 64 computer selected graphics symbols. Symbols include fractions and the £ symbol. Plotting is available at 80 x 72 resolution. Single or double-height characters, with flashing on an on/off duty cycle of 3-1. The board is memory mapped on any 2K boundary, with its I/O port set at any of the 256 available on the S100 bus. Just plug into your S100 system and colour television and go! Driver software and documentation provided. Price £295.00ex vat cash with order. Please specify if for television or 75 ohm monitor.



ON DEMO NOW! The Cromemco Z2-H.

For only £4,995.00 set the reliability and quality of Cromemco, coupled with the capacity of the new IMI 11 megabyte hard disk drive. This is incredible value for money. Specification includes transfer rates of up to 10 times faster than the fastest standard floppy disk, DMA controller for up to 7 hard disk units, and the new extended CDOS operating system. Systems available in three configurations: — A) The Z2-H complete integral system, 64K RAM, Z80A cpu, two double-sided mini-floppies, RS232 console port, parallel printer port, power supplies, cables, case and 12-slot S100 motherboard (7 slots free). B) Additional hard disk subsystem for existing system 2 or system 3 users consisting of one hard disk, DMA controller, power supply, case and cable. C) As unit B but with two hard disks. Prices: Unit A) £5,380.00
B) £4,330.00
C) £7,420.00

Xitan Systems also supplies and stocks vdu's, printers, NORTH STAR HORIZON computers, Commodore Business Machines PETs, S100 boards, and books. We are here to demonstrate the range of quality microcomputer systems available for use today. Ring up for an appointment now! You'll not be disappointed. We have Osborne's Sales Ledger and Payable Ledger in source form for use on Cromemco System 3 with CBASIC2, and we can offer a customising service on these programs. Additional software includes Microsoft Basic Interpreter and Compilers, Cbasic, Macro80, and CP/M for the North Star Horizon.

Xitan Systems Ltd., 23 Cumberland Place, Southampton SO1 2BB.

Tel: (0703) 38740

Hours Tue-Sat 9.30 am to 5.30 pm

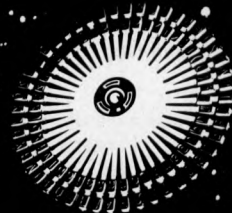
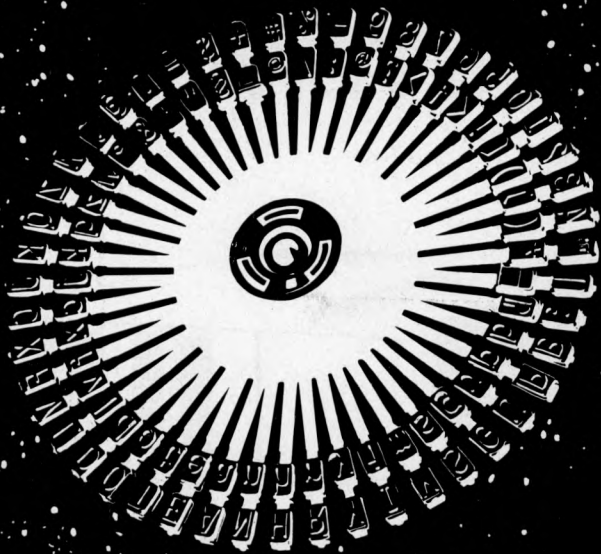

**small systems
presents**

PET COMPATIBLE DAISY WHEEL PRINTER

S.S.E. RICOH RP40

Printing Speed - 40 C.P.S.

Character-set - 96 characters, metal faced printwheel

Choice of typefaces

Line width - 136 characters (10 characters per inch)

Line width - 163 characters (12 characters per inch)

Form width - 16"

Integral PET IEEE-488 Addressable Interface

(Disc compatible)

240v 50Hz

Micro-Processor controlled

Reputation for high reliability

Options:-

Pin Feed Platen

Acoustic cover

Form Tractor

RS232 C Interface, Centronics Interface

**Complete word processing systems - Commodore PET,
Software and RP40 Printer also available.**

HIGH QUALITY PRINTING AT LOW COST £1590.00 inc. PET INTERFACE

 **Small
Systems
Engineering
Limited**

62 New Cavendish Street · London W1M 7LD Telephone: 01 637 0777 Telex: 8813085 (Abacus)

THE RESEARCH MACHINES 380Z COMPUTER SYSTEM



THE RESEARCH MACHINES 380Z A UNIQUE TOOL FOR RESEARCH AND EDUCATION

Microcomputers are extremely good value. The outright purchase price of a 380Z installation with dual mini floppy disk drives, digital I/O and a real-time clock, is about the same as the annual maintenance cost of a typical laboratory minicomputer. It is worth thinking about!

The **RESEARCH MACHINES 380Z** is an excellent microcomputer for on-line data logging and control. In university departments in general, it is also a very attractive alternative to a central mainframe. Having your own 380Z means an end to fighting the central operating system, immediate feedback of program bugs, no more queuing and a virtually unlimited computing budget. You can program in interactive BASIC or, using our unique Text Editor, run very large programs with a 380Z FORTRAN Compiler. If you already have a mini-computer, you can use your 380Z with a floppy disk system for data capture.

What about Schools and Colleges? You can purchase a 380Z for your Computer Science or Computer Studies department at about the same cost as a terminal. A 380Z has a performance equal to many minicomputers and is ideal for teaching BASIC and Csil. For A Level machine language instruction, the 380Z has the best software front panel of any computer. This enables a teacher to single-step through programs and observe the effects on registers and memory, using a single keystroke.

WHAT OTHER FEATURES SET THE 380Z APART?

The 380Z with its professional keyboard is a robust, hardwearing piece of equipment that will endure continual handling for years. It has an integral VDU interface — you only have to plug a black and white television into the system in order to provide a display

380Z/56K complete with DUAL FULL
FLOPPY DISK SYSTEM FDS-2

£3266.00

unit — you do not need to buy a separate terminal. The integral VDU interface gives you upper and *lower* case characters and low resolution graphics. Text and graphics can be mixed *anywhere* on the screen. The 380Z has an integral cassette interface, software and hardware, which uses *named* cassette files for both program and data storage. This means that it is easy to store more than one program per cassette.

Owners of a 380Z microcomputer can upgrade their system to include floppy (standard or mini) disk storage and take full advantage of a unique occurrence in the history of computing — the CP/M™* industry standard disk operating system. The 380Z uses an 8080 family microprocessor — the Z80 — and this has enabled us to use CP/M. This means that the 380Z user has access to a growing body of CP/M based software, supplied from many independent sources.

380Z mini floppy disk systems are available with the drives mounted in the computer case itself, presenting a compact and tidy installation. The FDS-2 standard floppy disk system uses double-sided disk drives, providing 1 Megabyte of on-line storage.

*Trademark, Digital Research.

Versions of BASIC are available with the 380Z which automatically provide controlled cassette data files, allow programs to be loaded from paper tape, mark sense card readers or from a mainframe. A disk BASIC is also available with serial and random access to disk files. Most BASICs are available in erasable ROM which will allow for periodic updating.

If you already have a teletype, the 380Z can use this for hard copy or for paper tape input. Alternatively, you can purchase a low cost 380Z compatible printer for under £300, or choose from a range of higher performance printers.

380Z/16K System with Keyboard

£965.00

RESEARCH MACHINES Computer Systems are distributed by RESEARCH MACHINES LTD., P.O. Box 75, Chapel Street, Oxford. Telephone: OXFORD (0865) 49792. Please send for the 380Z Information Leaflet. Prices do not include Carriage or VAT @ 15%.



COMPUTER WAREHOUSE

NOW OPEN
MONDAY-SATURDAY
9.30-5.30

HIGH DEFINITION 9" VIDEO MONITOR

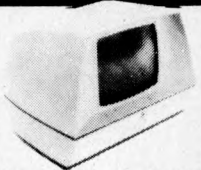

This superb ex computer video monitor was originally used as an information display on large computer systems. It features all silicon electronics, attractive style, housed in shatterproof two colour A.B.S. case with controls under flap. 240v operation. 625 lines, 75 or 50 ohm composite video input 50 Hz - 20 mhz frequency response. Supplied complete in good condition but untested and unguaranteed.

Connect direct to your M.P.U. at only **£47.50** P.P. £6.00
Supplied complete with circuit

DATA STORAGE MEDIUMS

RACAL C10 "Supergrade" cassettes complete with library cases 66p each 10 for **£5.45**
VERBATIM 5 1/4 soft sectored mini disks **£3.45** each 10 for **£31.63**

OPTO SMASH!

TIL 302/MAN 7 7 segment LED readout common anode direct drive (via resistors) from **7447** £1.10 each
TIL 119/OC72 Darlington opto isolator 3 for **£1.00**
TIL305 0.3 7 x 5 matrix LED alphanumeric readouts **£3.75** each.
PHOTO TRANSISTOR
Fairchild **FPT-100 NPN** silicon 30v 25ma. 4 for **£1.00**.

DISPLAY I.C. AND TRANSISTOR BARGAINS NEVER CHEAPER

All I.C.'s and Transistors by well known manufacturers and fully guaranteed. No fall outs. Comprehensive data on I.C.'s 15p per type.
2N4351 N channel MOS FET.
2N4352 P channel MOS FET.
50p each £1.00 per pair.
HIGH VOLTAGE NPN POWER SWITCHING transistors BVcbo 600v BVceo 500v BVebo 15v Ic 5 amps Pc 125 watts HFE 60 typ ft 2.5 mhz ideal invertors, etc. **T03** £1.60 each 4 for **£5.40**.
BF258 NPN 250v @ 200ma 45p each 3 for **£1.08**.
I.R. BSB01 2.5 amp 100v bridge rec. P.C. mount long leads 35p each 4 for **£1.08**.
IN4998 4 amp 100v P.C. mount diodes long leads 14p each 10 for **£1.10**.
LM309K +5v 1.2 amp regulator **£1.10** each 6 for **£5.35**.
2N1671B unijunction 450mw 30v 48p each 3 for **£1.00**.
IN4004 SD4 1 amp 400v diodes 7p each 18 for **£1.00**.
I.R. 12 amp BRIDGE RECS. 400v 100v £1.25 each.

POWER DARLINGTON SCOP!
MJ1000 NPN 60v 90w 8 amps T03 95p each
2N6385 PNP 80v 100w 10 amps T03 £1.25 each
MJ4030 NPN 60v 150w 16 amps T03 £2.25 each

PLESSEY EDGE STACKABLE DECADE THUMBWHEEL SWITCHES. Gold plated contacts dimensions 2 x 2 x 1/8 85p each 8 for **£5.35**.
28 way 0.156" double sided edge connector, easily cut **£1.25** each.
AMPHENOL 50Ω BNC plug 50p. **50Ω BNC** plug right angled 60p.
C90 Audio Cassettes screw type construction 45p each 3 for **£1.00**.
Bulbs 24v 14 watt white frosted S.B.C. 8 for **£1.00**.
Bulbs 12v 100 watt clear, base similar S.B.C. 45p each.
S.B.C. Bulb Holders All steel cad. plated panel mount easily fixed via nut and round hole, ideal disco displays, scoreboards, etc. 4 for **£1.10**.
Xtal filters S.E. 1 QC11211/B miniature low insertion loss P.C. mount. C.F. 10.7mhz with B.W. of 7.5khz 2000Ω imp in-out. Brand new @ **£7.99**.
Heavy Duty Flat Insulated Earth Braid 100-200 amp braided tinned copper in heavy clear PVC sheath 50p per metre. **£6** for 15 metres + **PP£1** per 15 metres.
BULGIN miniature 6 way male chassis mount socket and matching free plug 60p each, 2 for **£1.10**.
Red L.E.D.'s full spec. 0.2 14p each. 10 for **£1.25**.
Dynamic Stick Mics 600Ω with built in on/off switch complete with lead and min. jack plug **£1.15** each. 10 for **£10.00**.
T05 HEATSINKS "Thermalov" black anodised press on aluminium finned type 18p each. 8 for **£1.00**.

HARDWARE PACK Don't be stuck for the right nut and bolt for the job. Pack contains B.A. Metric, Unified, Self Tap, etc. Nuts, Bolts, Screws, Washers, etc. in Brass Bronze and Steel. All steel items plated. Average contents 400-600 pieces.
Sold by weight, **£2.65** 2lb bag.

MANY HUNDREDS OF TRANSFORMERS IN STOCK - SEND SAE FOR LIST
80 column **EXTEL 7 x 5** matrix printers. All TTL. **RS232** TTL interface, Baudot code, easily converted by software. **£165.00** + carriage & VAT.

TELETYPE
KSR33 20ma loop from **£150.00**
ASR33 20ma loop from **£275.00**



ELECTRONICS

Dept. P.C.W., 64-66 Melfort Road, Thornton Heath, Surrey
Telephone: 01-689 7702
Unless otherwise stated all prices inclusive of VAT. Cash with order. Minimum order value **£2.00**. Prices and Postage quoted for **UK** only. Where post and packing not indicated please add 30p per order. Bona Fide account orders minimum **£10.00**. Export and trade enquiries welcome. Orders despatched same day where possible. Access and Barclaycard Visa welcome.

In stock now test equipment, microprocessors, teletypes, transformers, power supplies, scopes, sig. gen's, motors, peripheral equipment, I.C.'s, tools, components, variacs, keyboards, transistors, microswitches, V.D.U.'s sub-assemblies + thousands of other stock lines. Just a mere fraction of our vast range. is displayed below 100's of bargains for callers

4k x 12 RAM static Memory card

Complete 4K x 12 bit memory system on one PCB. This ex computer memory card contains all relevant decoding, read write and control logic for coupling to your M.P.U. or mini computer system. TTL in and out make interfacing a "cinch". We understand that by reading the outputs correctly, the memory can be organised as a 6K x 8! Features include fast 250ns max. access time. Standard +12v -12v+5v power rails compact construction, non volatile memory, data remains even when power switched off! Original cost over **£800** each, supplied complete with full data and circuit manual, at an unbelievable price of **£39.95** P.P. **£1.75**
Note: Memories are removed from working equipment but supplied untested, unguaranteed

HOW TO GET HERE
Victoria, London Bridge or Holborn Viaduct to Thornton Heath. 1 minute from Thornton Heath Station.

SCOOP OF THE YEAR HAZELTINE H1200 V.D.U. TERMINAL

Due to a fantastic bulk purchase, we are now able to offer this superb terminal at a price almost below the cost of manufacture! Features include: 12" screen, 55 key TTY keyboard, full ASCII, RS232 interface, adjustable baud rate 75 to 9600, 12 lines x 80 characters (upgradable to 24 x 80), cursor control, lower case option, plus many other features.
Brand new at only **£250** CARR. + VAT.
FULL Technical Manual available

POWER SUPPLY UNITS

5 VOLT 2.5 AMP T.T.L. P.S.U.
Made for T.T.L. this compact ex computer systems unit features a 10 amp transformer with D.C. outputs of 5 volts @ 2.5 amps and 7.5 volts @ 5 amps. The 5 volt output is fully regulated and smoothed and has electronic current limiting. May be easily moded for 5 volts @ 7.8 amps, believed working but untested. 240v A.C. input
Complete with circuit **£8.25** P.P. **£1.60**

KEYBOARD



A special bulk purchase enables us to offer the above keyboard at a lowest ever price. 49 coded keys encoded into a direct TTL compatible 7 bit output. Features such as delayed strobe, 5 volt D.C. single rail operation and rollover protection make this an absolute must for the MPU constructor! Supplied complete with connection diagram and edge connector, at a secondhand "no time to test" price of only **£20.00** + P.P. **£1.60**
SUPER CASED VERSION Same as above spec. but housed in attractive two tone moulded, free standing case. Unit also includes an all TTL parallel to serial converter (no details) etc.
£27.50 + P.P. **£1.85**
Note, super cased version matches 9" video monitor

VMOS POWER FETS
Latest technology brings you the **SILICONIX VMOS POWER FETS** at a super scoop price. Capable of switching 2 amps D.C. @ 60v, D.C. - 200 MHz. Ideal interface, derived direct from VMOS. **£1.50** each, 10 for **£12.50**; full application data: 20p

OLIVETTI TE 300 TELETYPE The cheapest way for I/O and hardcopy is our second-hand Olivetti T.E. 300 teletypes. Full ASCII, serial interface 110 baud, integral paper tape panel and reader. Supplied in as seen condition, untested and unguaranteed at a once only price of **£130.00** plus carriage & VAT. Some technical literature available.

STOP PRESS LIMITED QUANTITY

Just arrived, details not yet fully known **VENTEK VDU TERMINALS**. 12inch diagonal green screen, RS232 interface, full keyboard including cursor control, Believed 24 lines x 80 characters. Phone for further details. Second-hand price **£225** plus carriage & VAT.

HY GRADE SMOOTHING CAPS
MULLARD - PLESSEY - MALLORY - SPRAGUE
1500mf 100v 60p* 3300mf 40v 50p
3300mf 63v 70p* 1mf 600v MYLAR 28p
10,000mf 15v £1+ 22,000mf 16v £1.10+
100mf 250v 45p 2100mf 200v £2.50+
*Ex equipment tested +P.P. 40p

SEMICONDUCTOR 'GRAB BAGS'

Amazing value mixed semiconductors, include transistors, digital, linear I.C.'s, triacs, diodes, bridge recs. etc. All devices guaranteed brand new, full spec. with manufacturers markings, fully guaranteed.
50 + BAG **£2.95** 100 + BAGS **£5.15**

MUFFIN FANS

ideal equipment cooling etc. tested, ex equipment
★ 240v 50-60 HZ **£5.15** + p.p. 45p ★
110v 50-60 HZ **£5.05** + p.p. 45p

ELECTRONIC COMPONENTS & EQUIPMENT **66%** DISCOUNT

Due to our massive bulk purchasing programme which enables us to bring you the best possible bargains, we have thousands of I.C.'s Transistors, Relays, Cap's., P.C.B.'s, Sub-assemblies, Switches, etc. etc. surplus to our requirements. Because we don't have sufficient stocks of any one item to include in our ads., we are packing all these items into the "BARGAIN PARCEL OF A LIFETIME". Thousands of components at giveaway prices! Guaranteed to be worth at least 3 times what you pay plus we always include something from our ads for unbeatable value!! Sold by weight
7lb £ 5.25 **14lb £ 7.95**
28lb £13.75 **56lb £22.00**
PLEASE ADD P + P £1.25

ISOLATED 240v 4 AMP & 10 AMP SOLID STATE RELAYS

Interface your MPU etc. with the outside world made by the famous "Astralux" Co. They consist of a miniature plastic module with mounting holes containing a reed relay for isolation, choke and triac. 12-20 volts D.C. at a few milliamps enable on/off control of A.C. loads up to 10 amp! The 10 amp version should be mounted on a heatsink. 100's of uses including power control, lighting, etc. etc.
Dimensions: 4 amp, 1 1/2" x 1 1/2" x 1 1/2", 10 amp, 1 1/2" x 1 1/2" x 1 1/2".
4 amp **£1.45** 10 amp **£2.10** complete with circuit

The Perfect Lead... Acorn Microcomputer System 1



Price £65 plus VAT in kit form

This compact stand-alone microcomputer is based on standard Eurocard modules, and employs the highly popular 6502 MPU (as used in APPLE, PET, KIM, etc). Throughout, the design philosophy has been to provide full expandability, versatility and economy.

Specification

The Acorn consists of two single Eurocards.

1. MPU card
 - 6502 microprocessor
 - 512 x 8 ACORN monitor
 - 1 K x 8 RAM
 - 16-way I/O with 128 bytes of RAM
 - 1 MHz crystal
 - 5 V regulator, sockets for 2K EPROM and second RAM I/O chip.
 2. Keyboard card
 - 25 click-keys (16 hex, 9 control)
 - 8 digit, 7 segment display
 - CUTS standard crystal controlled tape interface circuitry.
- Keyboard instructions:
Memory Inspect/Change (remembers last address used)
Stepping up through memory
Stepping down through memory

Set or clear break point

Restore from break

Load from tape

Store on tape

Go (recalls last address used)

Reset

Monitor features

System program

Set of sub-routines for use in programming

Powerful de-bugging facility

Displays all internal registers

Tape load and store

routines

Applications

As a self teaching tool for beginners to computing.

As a low cost 6502 development system for industry.

As a basis for a powerful microcomputer in its expanded form.

As a control system for electronics engineers.

As a data acquisition system for laboratories.

START WITH SYSTEM 1 AND CONTINUE AS AND WHEN YOU LIKE

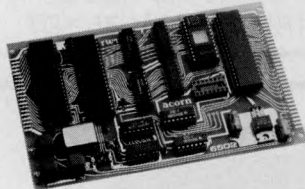

Acorn Controller
£35 plus VAT (min config.)

the CPU card of System 1, it allows for up to 4½ k EPROM, 1½ k RAM and 32 I/O lines. It has on board 5 V regulator and optional crystal control. Custom programs may be developed on System 1 and the card makes an ideal dedicated hardware module.

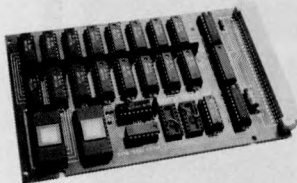

Acorn Memory 8 k
£95 plus VAT (kit form)

A fully buffered memory card allowing up to 8 k RAM plus 8 k EPROM on one eurocard, in an Acorn system both BASIC and DOS may be contained in this module. Static RAM (2114) is used and the card may be wired into other systems.

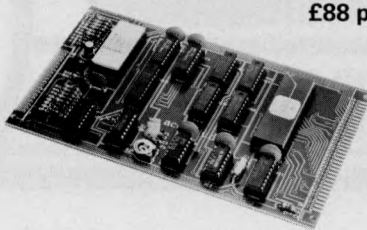

Acorn VDU
£88 plus VAT (kit form)

A memory mapped seven colour VDU interface with adjustable screen format. Full upper and lower ascii and teletext graphics are features of this module which along with programmable cursor, light pen, hardware scroll etc., make this the most advanced interface in its class.

Acorn Software
in ROM

- Acorn BASIC — a very fast integer BASIC in 4 k
- Acorn COS — a sophisticated cassette operating system with load and save and keyboard and VDU routines in 2 k
- Acorn DOS — a comprehensive disc operating system in 4 k

Acorn Computers Ltd.
4A Market Hill, Cambridge, Cambs.
Cambridge (0223) 312772.

Order Form

Please send me the following:

- (qty) Acorn Microcomputer kit @ £65 plus £9.75 VAT.
- (qty) Acorn Memory kit @ £95 plus £14.25 VAT.
- (qty) Acorn VDU kit @ £88 plus £13.20 VAT.
- (qty) Acorn Power Supply (for System 1 only) @ £5.95 plus £0.89 VAT.
- (qty) Acorn Microcomputer assembled and tested @ £79 plus £11.85 VAT.
- (qty) Acorn VDU assembled and tested @ £98 plus £14.70 VAT.

Post and packing free on all orders.

I enclose a cheque for £

(indicate total amount) made out to Acorn Computers Ltd.

Please send me further details of this and other Acorn options

Name _____

Address _____



Acorn Computers Ltd. 4A Market Hill, Cambridge, Cambs. (0223) 312772. Regd. No. 1403810



Buy
with confidence
from the specialists
HB COMPUTERS LTD

Stock a full range
Under One Roof

**BUSINESS AND GAMES SOFTWARE
FOR THE CBM PET**

**DISC BASED BUSINESS SOFTWARE
CBM 3040 AND COMPU/THINK**

SALES LEDGER

Process up to 1,000 accounts. Full input audit trail,
enquiries, statements, debtors list and sales analysis.
.....£350

PURCHASE LEDGER

Specifications as per Sales Ledger.£350

ESTATE AGENT

Property file maintained and houses selected.
.....£25.00

WORD PROCESSOR

All the usual word processor features plus global
changes and right justify.£50.00

MAIL LIST

Names, addresses and selection codes on disc. Will
interface with our word processor.£50.00

CASSETTE BASED SOFTWARE

STOCK WATCHER

Up to 250 stock items processed. Stock Reports,
re-order, etc.£25.00

R H SHAPEMATCH

Memory game. Children love this one.£5.00

R H MASTERMIND

Our version of this popular brain teaser.£8.00

SNAKES & LADDERS

You choose the number of snakes and ladders.
Good graphics. Works with our SOUNDBOX . . .
.....£8.00

R H MICROPOLY

Monopoly board controlled by your PET. Nobody
is lumbered with the bank.£12.00

HB COMPUTERS LTD

22 NEWLAND STREET, KETTERING
NORTHANTS.

Tel. (0536) 83922 & 520910 Telex 341297

All prices exclude VAT.

**Q-COM
ELECTRONICS**

PET PERIPHERAL SPECIALISTS

PLESSEY MEMORIES 32K WORDS

PETITE (add on) £280
INPET (mounted inside) £249

**I EEE-488 SERIAL OUTPUT
INTERFACE**

SELF POWERED £110
P.C. BOARD ONLY £ 85

TERMINALS:-

DECWRITER LA34 £850
TELETYPE 43 £795

**TERMS:- ALL EQUIPMENT EX-STOCK
CASH WITH ORDER PLEASE -
VAT EXTRA. 3 MONTHS' WARRANTY.
TERMINAL DELIVERY £15 EXTRA.
FULL BACK UP SERVICE AVAILABLE**

TELEPHONE 021-653-1945
OR 021-643-3540
OR 021-643-3540

**Q-COM ELECTRONICS LTD.,
5TH FLOOR, ST. MARTINS HOUSE
10 BULL RING, BIRMINGHAM B5 5DT**



Apples don't grow on trees anymore,
and chips don't come with fish.
But there's a nice new place in Croydon,
where they serve up an interesting dish.

See us at:

28 Lower Addiscombe Road,
Croydon.

Or phone: 01-680 4646.



NewBear —Components—



MICROCOMPUTING I.C.'s

Z8001	£142.50
MC6800	£ 7.15
MC6802	£ 8.50
MC6821	£ 4.63
MC6850	£ 6.74
MC6810AP	£ 3.61
MC6840	£ 12.72
MC8602P	£ 2.88
MC14536P	£ 3.69
MC3459	£ 2.43
Z80 CPU 2.5MHz	£ 8.99
Z80 P10 2.5MHz	£ 7.99
Z80 CTC 2.5MHz	£ 7.99
Z80A CPU 4MHz	£ 13.99
Z80A P10 4MHz	£ 10.00
Z80A CTC 4MHz	£ 10.00
SC/MP 11 (INS 8060N)	£ 8.88
INS 8154N	£ 8.18
8080A	£ 6.00
6502	£ 12.00
6522	£ 6.58
6532	£ 12.56
6545	£ 16.66
6551	£ 10.79

77-68 Prices Slashed!

Bearbag 1	77-68 CPU KIT	£35.00
Bearbag 5	77-68 4K RAM KIT	£55.00
Bearbag 6	77-68 MON 1 KIT	£37.50
Bearbag 12	77-68 V.D.U. KIT	£42.50
Bearbag 13	77-68 MON 2 KIT	£47.50
Bearbag 16	77-68 EPROM BOARD KIT	£21.50
Bearbag 17	77-68 PIO BOARD KIT	£40.00
Bearbag 23	77-68 32K DYNARAM KIT	£75.50
Bearbag 18	CASSETTE INTERFACE	£12.50

- ★ SUPERBOARD II £188
 - ★ 610 EXTENSION BOARD £188
 - ★ FLOPPY DISC DRIVE £312
- (includes DOS, 12K Basic, Case & PSU)

MEMORIES

2708	£6.99
4116 (16K DYNAMIC)	£6.99
2102-1	£0.85
2102L-1	£0.99
2112	£2.25
2114	£6.99
2716 (INTEL)	£21.50

NASCOM II £295.00

- ☆ 2K GRAPHICS ROM £15.00
- ☆ POWER SUPPLY £29.50

SHARP MZ 80K at NEWBEAR

S100 BUS

8 Slot Motherboard	£ 32.00
12 Slot Motherboard	£ 38.00
20 Slot Motherboard	£ 45.00
Z80 CPU Board	£ 26.25
Z80 CPU Board Ass. 4MHz	£153.75
Z80 CPU Board Ass. 2MHz	£131.25
V.D.U. Board	£ 18.75
V.D.U. Board Assembled	£108.75
Floppy Disc Controller Board	£ 26.25
Floppy Disc Controller Board Ass.	£131.25
2708/2716 Eprom Board	£ 18.75
2708/2716 Eprom Board Assembled	£ 63.75
8K Static Ram Board	£ 18.75
8K Static Ram Board Ass. 250 NS	£146.25
8K Static Ram Board Ass. 450 NS	£123.75
Prototype Board	£ 18.75

VERO

SEND FOR LIST OF VEROBOARDS, BOXES AND INTERCONNECTING SYSTEM

ACORN

6502 BASED MICRO KIT	£65.00
8K RAM KIT	£95.00
MAINS ADAPTOR	£ 5.00
V.D.U. KIT	£88.00



NEWBEAR SYSTEMS FOR APPLE II, HORIZON AND SHARP.

TERMS: Credit Sales (minimum £10.00) Barclaycard and Access Welcome. Please add 15% VAT.
SEND FOR OUR BOOK LIST
AND NEW FULL CATALOGUE

CALLERS AND MAIL ORDER: 40 Bartholomew Street, Newbury, Berks. Tel: 0635 30505

CALLERS ONLY: 220-222 Stockport Road, Cheadle Heath, Stockport Tel: 061 491 2290

AERCOGEMSOFT

THE BEST SELECTION OF MICRO-COMPUTERS
IN THE WOKING AREA

VIDEO GENIE: 16k memory (expandable to 48k), large keyboard, internal cassette drive (with counter!), uses TRS-80 software! 12k Microsoft basic in ROM, other languages available, plugs into TV set or video monitor, parallel interface, full expandable to disks and printer. Only £369.57 (£425 inc. VAT)!!!

APPLE 2: The best of the microcomputers, 16k b&w, now at the new low price of £695.00. All cards in stock.

SUPERBRAIN: 64k RAM, CPM disk operating system (Z80), 12" integral VDU, serial and parallel interfaces, comprehensive keyboard, Fortran, Cobal and Basic available, just add a printer for a complete system. £1995.00. NOW IN STOCK.

OHIO SCIENTIFIC: Selection of Challenger 2 and Challenger 3 machines. 1.2mb disks, from £2450.00.

SOFTWARE

Viasak software for Apple:

Sales ledger: £315; Purchase ledger: £315; Nominal ledger: £225 (an integrated system); Payroll: £375 (the best we have ever seen).

One of Gemsoft's specialities is word processing, and we have a selection of programs for Apple and Ohio available. The new Apple word processor is only £42. A complete word processing system, including Apple, Qume daisy wheel printer, video monitor etc. is £3,500.00.

Lots of other Gemsoft software available including stock control, production control and imported American software for Apple, TRS-80 and Video Genie.

Please add 15% VAT to the above prices.
Send now for our catalogue containing the
NEW LOW
Apple prices, and details of all the other items
in stock.

AERCO-GEMSOFT,
27 Chobham Road, Woking, Surrey GU21 1JD.
Tel: (04862) 22881

Open 6 days a week 9.30 a.m.—6 p.m.

L & J COMPUTERS



KEEN & COMPETITIVE!

WE ARE SPECIALISTS.
'PET' SPECIALISTS.
HARDWARE & SOFTWARE.

WE HAVE EXCELLENT
STOCKS OF BOTH



Inc. a full range of Commodores and Petsoft; and, of course, our own, such as:

Stock Control & Invoicing	£ 60
Random Entry & Analysis	£ 40
Delivery Services	£220
Work Study	£150
Monthly Planner	£ 7

etc. etc. (SAE for descriptive leaflet)

We will also write programs for you that you are unable to do or get written.

YOU ARE WELCOME TO TRY, BROWSE & PURCHASE AT OUR PREMISES . . . TRY US!

ORDERS TAKEN BY POST OR PHONE: ACCESS-BARCLAYCARD-VISA

**3 CRUNDALE AVENUE, KINGSBURY
LONDON NW9 9PJ 01-204 7525**

A SOUND INVESTMENT.

MP 12 and MP 15 Microprocessor Cassettes



When you record on cheap cassettes you run a high risk of program failure, dropout errors and excessive headwear.

Saving pennies on an unsuitable cassette could turn out to be very costly. To make a long life, high quality microprocessor cassette needs both tape and cassette mechanism to operate together in harmony.

Backing up the microprocessor cassette technology is a background of more than 10 years of experience within the Group on the manufacture of computer tape, memory discs and cartridges. Pyral is one of Europe's foremost manufacturers of magnetic digital recording media.

The perfect match of cassette body and tape.

For further information on the
Microprocessor cassette and other
Pyral products, send to:

Sales office: PYRAL MAGNETICS LTD, COURTLANDS ROAD, EASTBOURNE, SUSSEX. Tel: (0323) 638965 Telex: 877123

Sintrom Microshop

The S100 computer centre

Sintrom Periflex microcomputer with both
5" and 8" floppy disc drives

Vector Graphic microcomputers

Micropolis 5" floppy disc drives (now in stock)

Micropolis 8" Winchester / S100 systems

Telema computer systems

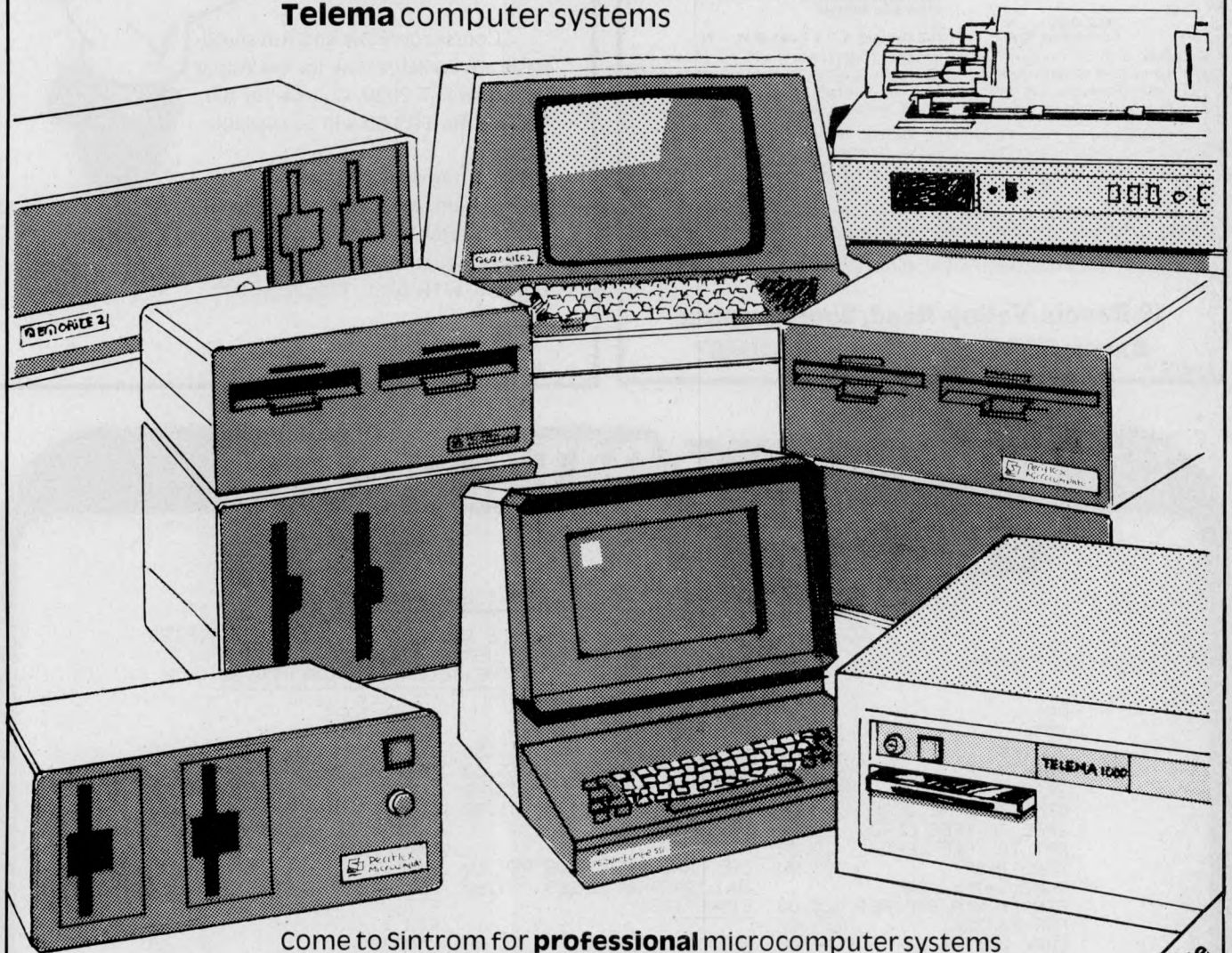

Come to Sintrom for **professional** microcomputer systems backed-up by the long established Sintrom Group, with years of experience in mini and micro computer systems and peripherals.



Sintrom Electronics

14 Arkwright Road, Reading, Berks RG2 0LS

Tel: Reading (0734) 85464 TELEX: 847395

Sintrom Microshop is a division of the
Sintrom Group of Companies

**Very competitive terms available
for dealers and OEMs**
Phone Martin Whittaker
on (0734) 85464
for further details

Happy Memories

21L02	450ns	83p	16K Memory Upgrade Kits for TRS-80, Apple and Sorcerer	42.50
21L02	250ns	1.00	All at	
2114	450ns	4.95	Vero S100 Products:	
4116	300ns	4.25	6 Slot Card Frame with Power Supply	241.36
		450	Prototyping Cards (3 types) ea.	13.66
4116	150ns	5.50	Extender Card	21.70
2708	450ns	5.95	Motherboard with 6 connectors	67.65
2716	5v	19.95		
IC Sockets:				
Pins	Solder	W/W	Ithaca Intersystems Products:	
8	10p	24p	S100 Z80 CPU Card 4MHz A/T	176.81
			" " " " 2MHz "	150.94
			" " " " Bare	
14	11p	36p	Board	30.19
16	12p	39p	S100 Video Display Board A/T	125.06
18	16p	46p	" " " " Bare Board	21.56
20	17p	58p	S100 16 x 2708/2716 A/T	73.31
22	19p	61p	" " " " Bare Board	21.56
24	21p	63p	S100 Proto Board (Plated Through)	21.56
28	27p	70p	See Ithaca's own advertisement for full range	
40	37p	109p	VERBATIM Mini-discs (Pet, TRS-80 etc)	10 19.95
SAA5050				
		14.85	Cannon MIN-D 25 way Connectors: Female	1.65
		7.15	Male 1.45; Hoods 57p	
SAA5020	7.99	7.99	Other sizes available	
81LS96		1.50	DIN 41612 Euroconnectors	
81LS97		1.54	64 way: Female	3.17
			Right-angled Male 1.93	
			Other sizes available	
74LS series:				
Lots of them POA			DIP Switches: 4, 7 & 8 way all at	85

We stock a full range of Wire-Wrapping equipment and supplies for you to choose from; we have shelves of books- give us a ring with your requirements and avoid crippling postage charges. Our stocks are too numerous to list here- free price lists sent upon request

The shop is open from 10 until 6 Monday to Saturday and is worth a visit to catch a surplus bargain- Keyboards at 39.50 today, we may have some left when this gets to print ? 18 slot S100 Mother Boards at 22.50 ? Double Eurocard prototyping boards for a pound

ALL PRICES INCLUDE VAT. POSTAGE FREE ON ORDERS OVER 10 POUNDS IN VALUE, OTHERWISE ADD 25p. ACCESS AND BARCLAYCARD WELCOME, YOU MAY TELEPHONE WITH YOUR CARD NUMBER AND REQUIREMENTS. TRADE ACCOUNTS ON APPLICATION, GOVERNMENT & EDUCATIONAL ORDERS WELCOME £10 MIN.

**19 Bevois Valley Road, Southampton,
Hants. SO2 0JP Tel: (0703) 39267**

Dept PC.W.

MEET THE LITTLE GENIUS

If you find self-instruction manuals difficult to follow then meet our Little Genius.

Little Genius floppy diskettes are the fastest, easiest way to master your micro.

Little Genius will save you time and effort, teaching you to exploit all your micro's facilities.

Courses on Basic and Advanced Basic are available now for the Apple 2 and the ITT 2020. Courses for the Pet and the TRS 80 will be available shortly.

For a free demonstration or more information, ask your local dealer or contact Peter Brown at Suite 504 Albany House, 324 Regent Street, London, W1R 5AA. Telephone 01-580 6361.



Intex DATALOG LTD COMPUTERS

MAIL ORDER DEPARTMENT

CASH WITH ORDER ONLY

ALL GOODS DESPATCHED BY RETURN OF POST OR YOU WILL BE NOTIFIED OF ANY DELAY & OFFERED AN ALTERNATIVE OR THE RETURN OF YOUR MONIES

PET

2001-8	495.00
3016	675.00
3032	795.00
C2N CASSETTE DECK	55.00
IEEE TO IEEE LEAD	25.00
PET TO IEEE LEAD	20.00
3040 DISK	795.00
COMPUTHINK 400K	
FOR 8K VIA EXP/PET	825.00
FOR 16/32K	895.00
800K UNIT	1145.00
24K EXPANDAPET	320.00
<u>INTERFACES</u>	
SMALL SYS. SERIAL C	120.00
SERIAL B BI-DIR	175.00
TNW2000 BI-DIR	165.00
ALL IEEE/RS232	
PETSET 1 A/D	166.00
STOCKISTS OF PETSOFT & COMMODORE SOFTWARE	

PAPER

TCM100 ROLL	2.50
ANADIX/PET 800COL	15.00
TELETYPE 132 COL	25.00
PR-40 ROLL	1.00
<u>CASSETTES</u>	
C15 CASS HIGHGRADE PER 10	
IN LIBRARY CASES	4.00
<u>DISKETTES</u>	
PET 3040 PER 10	30.00
APPLE PER 10	30.00
C/THINK D/D PER 10	35.00
<u>DEMAGNETISERS</u>	
CURVED HEAD (MAINS)	4.00
CASSETTE (BATTERY)	12.00
<u>WORKBOOKS</u>	
TIS WORKBOOKS (NO VAT)	
SET OF 6	18.00

CONNECTORS

PET USER/IEEE PORT	1.25
PET 2ND CASS PORT	.95
COVERS FOR USER/IEEE PORT	
CONNECTOR	2.50
D25 RS232 CONNECTORS	
MALE/FEMALE	3.25
COVERS	2.50
<u>KIM</u>	
KIM 1	99.95
KIM 3B	129.95
KIM 4	69.95
<u>NASCOM</u>	
NASCOM 1 (KIT)	125.00
NASCOM 1 (BUILT)	140.00
NASCOM 2 (KIT)	295.00
POWER SUPPLY (KIT)	29.50

SEND FOR OUR FULL SOFTWARE & MAIL ORDER PRICE LIST --	

MAIL ORDER DEPT. EAGLESLIFFE IND. EST.
EAGLESLIFFE CLEVELAND TS16 0PN
TEL 0642 781193 TELEX 58252

ALL PRICES ARE EX. VAT.
PLEASE ADD 50P P+P ON SMALL ITEMS
2.50 P+P ON LARGE ITEMS

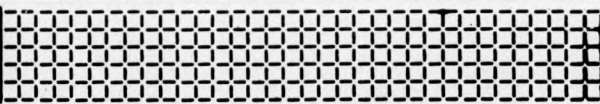

Intex

THE SATELLITE VIDEO KEYBOARD TERMINAL



**GIVES YOU
MORE ON
YOUR SCREEN**

(INCLUDING 128 GRAPHICS CHARACTERS).

The Satellite is based on the KTM Keyboards made by Synertek. The on-board microprocessor gives full control over the display allowing not only the full ASCII character set to be displayed, but also 64 graphics characters which, with reverse video becomes 128.

An auxiliary serial port allows onward transmission to or from a remote peripheral such as a printer, or modem, and may be switched on and off under software control.

The Satellite comes built and tested. All you need is a monitor (a television and modulator may be used with the Satellite 1) and a 5V 1.25A power supply. If RS232 is to be used, then +12 at 100mA is also required.

SATELLITE 1 24 rows of 40 characters £215 + VAT.

SATELLITE 2 24 rows of 80 characters £250 + VAT.

(Dealer Enquiries Welcome).

SPECIFICATION.

- * 24 rows of 40 or 80 characters.
- * Full 128 ASCII Character Set.
- PLUS 128 graphics characters.
- * Full RS232 or TTL Serial Interface with RS232 handshaking.
- * Auxiliary RS232/TTL Serial Port for printer, modem, etc.
- * Interface/non-interface.
- * Line truncate/non-truncate.
- * Direct cursor addressing.
- * Switch selectable European/USA standard.

**INTERACTIVE DATA SYSTEMS 14, BUCKMAN CLOSE,
GREENLEYS—MILTON KEYNES. Telephone: (0908) 313997.**

New low book prices

Also dealers for Acorn, Apple, Microstar and Alpha Micro.

BASIC & BASIC PROGRAMS

Running Wild: The Next Industrial Revolution Adam Osborne	£ 3.50
The Mighty Micro Chris Evans	£ 5.50
X1 Microprocessor Lexicon Sybex Inc.	£ 2.50
Microelectronics Scientific American	£ 4.00
Mind Appliance T G Lewis	£ 4.80
Introduction to Microcomputers Vol 0 — The Beginner's Book Adam Osborne	£ 5.40
Introduction to Microcomputers Volume 1 — Basic Concepts Adam Osborne	£ 5.90
Your Home Computer James White	£ 5.90
Peanut Butter & Jelly Guide to Computers Jerry Willis	£ 6.30
C201 Microprocessors: from Chips to Systems Rodnay Zaks	£ 6.90
Illustrating BASIC Donald Alcock	£ 2.30
Microcomputers in the Three R's: A Teacher's Guide Christine Doerr	£ 4.90
Little Book of BASIC Style: How to write a program you can read John Nevison	£ 5.40
Programming in BASIC for Business Bosworth/Nagel	£ 6.90
Basic Handbook David Lien	£11.00
BASIC and the Personal Computer Dwyer/Critchfield	£11.90
Computer Programs that Work! Lee/Beech/Lee	£ 3.00
Basic Computer Games David Ahl (Ed)	£ 5.50
More Computer Games David Ahl (Ed)	£ 5.50
Some Common BASIC Programs Poole/Borchers	£ 6.50
6502/6800/8080/Z80	
8080A/8085 Assembly Language Programming Lance Leventhal	£ 6.30
Z80 Assembly Language Programming Lance Leventhal	£ 6.90
Z80 Microcomputer Handbook William Barden	£ 6.90
Sargon: A Computer Chess Program Dan & Kathe Spracklen	£ 9.50

Your key.

To MICROCOMPUTERS

This coupon will bring you details of our new complete home computer course.

You will learn all the basic principles of computer technology and receive full instruction on computer functions and programming. Tuition is carried out at your own pace on your own home computer and is supervised by our qualified computer staff.

**FREE
BROCHURES**

Send today for a brochure on this exciting new course.

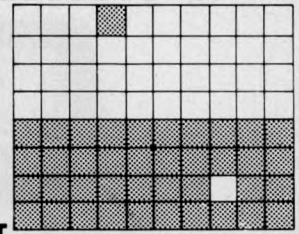

TUTORCOURSE
HOME COMPUTER

Please rush me details of your HOME COMPUTER COURSE

Name

Address

Block Caps. Please

Post now, without obligation to:

**British National Radio
& Electronics School.**

P.O.Box 156, Jersey, Channel Isles



CompUtopia
LIMITED

30 Lake Street, Leighton Buzzard, Bedfordshire
Tel: (0525) 376600 24 hour Answering Service

6800 Assembly Language Programming Lance Leventhal	£ 6.30
6502 Assembly Language Programming Lance Leventhal	£ 6.90
C202 Programming the 6502 Rodnay Zaks	£ 6.90
First Book of KIM Butterfield et al	£ 7.00
D302 6502 Applications Book Rodnay Zaks	£ 7.90
Programming a Microcomputer: 6502 Microprogram- ming MOS' KIM-1 Caxton C Foster	£ 7.90
Practical Introduction to Pascal Wilson/Addyman	£ 4.00
Pascal User Manual & Report Jensen/Wirth	£ 5.90
Introduction to Pascal Welsh/Elder	£ 7.00
Programming in Pascal Peter Grogono	£ 7.80
Microcomputer Problem Solving using Pascal Kenneth Bowles	£ 7.90
OTHER READING	
Cheap Video Cookbook Don Lacaster	£ 4.40
How to Build a Computer-Controlled Robot Tod Loofbourrow	£ 4.90
C207 Microprocessors' Interfacing Techniques Lesea/Zaks	£ 7.90
Computerisation: Layman's Guide for Directors & Senior Management E G Cluff	£ 4.90
How to Profit from your Personal Computer T G Lewis	£ 5.50
Vol 1 Fundamental Algorithms Donald Knuth	£10.50

Books will be despatched within 24 hours or our acknowledgment giving precise delivery date. All prices include p&p within the UK. Outside the UK please add 10%.

For details please contact 30 Lake Street, Leighton Buzzard.
Tel: (0525) 376600. When ordering please state your cheque/
postal order/Barclaycard number.

PETALECT

**ELECTRONIC
SERVICING LTD.**



Petact authorised distributors for central Southern England for the full range of Computhink disc systems (dealer enquiries welcome)

Computhink Old ROM 400K	£795.00
" New ROM 400K	£795.00
" New ROM 800K	£995.00
All + VAT	

Large Keyboard PETS in stock 32K PET £795 + VAT 16K PET Ask for delivery on 16 2040 Disc System and C.B.M Printers. Large Extension Keyboard for the PET £89.50 + VAT.

Stockists for Petact Business Systems (Sales accounting, purchase invoicing, payroll, Stock Control, Nominal Ledger and management information.
A wide range of Printers available i.e. Teletype 43, Anadex C.B.M, Printerm

COMPUTER BOOKS — for professionals, hobbyists, businessmen and newcomers.

ACCESS, BARCLAYCARD

We also supply: **Apple II** 16K, 32K or 48K, mini-disk drives, interface cards and software.

If you require any more information or demonstration regarding the PET 2001/8 or any associated equipment, programs, etc., please contact:
Mr. P.J.A. Watts or Mr. D.W. Randall at:

PETALECT ELECTRONIC SERVICES LTD
33/35 Portugal Road
Woking
Surrey
Tel: Woking 69032/68497

Shop at:
PETALECT
Chertsey Road
Woking
Surrey
Tel: Woking 21776/23637

CASIO FX 502P PROGRAMMABLE CALCULATOR

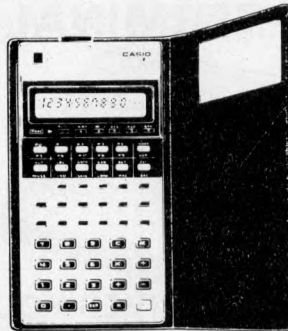

- LINKS UP WITH AN ADAPTOR FOR PROGRAMME - DATA STORAGE ON STANDARD CASSETTES, PLUS MUSIC SYNTHESIZING AND PLAY-BACK
- 256-step programme memory and 22 data registers are both protected (non-volatile)
- Up to 10 levels of parenthesis nesting
- True algebraic logic - easy key operations same as written formulae
- Battery service life is 1,300 hours Auto power-off feature is provided
- Thin and lightweight - easy to carry around
- Up to 10 programmes available - programme keys otherwise usable as user's functions
- 51 built-in functions all usable in programmes
- A variety of "jump" commands unconditional jumps, conditional jumps and indirect jump
- Up to 9 subroutines incorporable - nesting possible up to 9 levels
- Easy to edit and debug programmes PAUSE key, random number key, back step/rapid run key
- Amazing operating speed

Optional FA-1 Programme Adaptor permits programme/data storage on standard cassette tape recorders for re-entry. Typical storage/re-entry time 9-16 seconds, with a three digit code for programme reference and identification. Also contains a music switch which converts both calculators into musical synthesisers - duration of notes, rests, tempo, slur and tie are all programmable.

MODEL FX-501P has an identical specification with the following exceptions: 128 steps (non-volatile) programme memory capacity; 11 (non-volatile) data registers; up to 5 levels of parenthesis nesting; up to 9 subroutines, nestable up to 4 levels; up to 15 music notes (FX-502P up to 20)

Dimensions of both are 9.6 mm H x 71 mm w x 141.2 mm D (2" H x 2 7/8" W x 5 1/2" D) A comprehensive Programme Manual, Instruction Booklet and leatherette wallet are supplied. FA-1 comes complete with a demonstration cassette with pre-recorded programs, including games and music.

AVAILABLE BY MAIL ORDER AT LOWEST DISCOUNT PRICES

FX-501P (RRP £64.95)	FX-502P (RRP £84.95)	FA-1 (RRP £24.95)
£54.95	£74.95	£19.95

Master Package deal. Premier Publications Master Pack software kit only when you buy the FX-501P and FA-1, or FX-502P and FA-1. Usual price **£17.95**.
Master Pack comprises USER MANUAL with Basic and Advanced programming etc. PLUS cassette with over 150 ready-to-run programs. Full cassette library, personal.
Computer programmes, banking, diet, biorhythms, powerful sub-routines, and data-packing.
Prices include VAT at 15% and post and packing. Send your Company order, cheque or Postal Orders, or phone your ACCESS or BARCLAY CARD number to

TEMPUS DEPT PCW
THE BEAUMONT CENTRE
164-167 EAST ROAD
CAMBRIDGE CB1 1DB
Tel: (0223) 312866

SUPPORT MEMBERS OF THE COMPUTER RETAILERS ASSOCIATION...



THEY WILL SUPPORT YOU.

For further details on the associations aims, membership, code of conduct etc.

Please contact: Mrs H. Gibbons, C.R.A., Owles Hall, Buntingford, Hertfordshire. (0763) 71209.

Grangewood GROUP OF COMPANIES

HOME + BUSINESS COMPUTERS

"PETSHOP" 8K NEW KEYBOARD £495.00
 16K £675.00
 32K £795.00

TRACTOR FEED PRINTER £645.00

EXTERNAL CASSETTE DECK £55.00

WE ARE A PETSOFT DEALER - TAPE AND DISK
 BASED SOFTWARE IN STOCK
 SORCERER 32K £859.00

THE VIDEO DISK SYSTEM(MICROPOLIS TWIN DISKS
 613K) £1800.00

N.E.C. SPIN WRITER £1900.00

WORD PROCESSOR PACK £120.00

THE Z80 SORCERER IS NOW WELL SUPPORTED
 BY BUSINESS SOFTWARE. PLEASE PHONE
 FOR DETAILS.

AGENTS FOR COMPUCORP THE "EXECUTIVE"
 COMPUTER

BROCHURES AND PRICES ON REQUEST.



ACCESS

/BARCLAY CARD

ALL ITEMS OF HARDWARE IN STOCK AT TIME
 OF GOING TO PRESS

ALL PRICES EXCLUSIVE VAT. FINANCE
 AVAILABLE. 20% DEPOSIT

445 HIGH STREET NORTH, MANOR PARK,
 LONDON E12

PHONE ANYTIME 01 472 5107

**DISKETTES RIBBONS TAPES
 HIGH QUALITY PROFESSIONAL SERVICE**

from
MEDIA MAIL ORDER

All our high-quality products are tested to
 industry standards.

Your orders receive prompt professional service
 from MEDIA MAIL ORDER.

Customer confidence is important to us, we will
 ensure that you receive the best media for
 your system.

Ask for our catalog or order your floppies now
 from this small selection from our range.

Minifloppy for PET-APPLE-TRS-80 £2.20 ea.

8" Disk. S/side S/dens Soft sector £2.90 ea.

8" Disk. S/side S/dens Hard sector £2.90 ea

Many other types by return. Add 15% VAT

Discounts for quantities over 10+.

Please send your FREE CATALOG and the
 following disks for my machine type:

.....

Disk type. Qty

I enclose: £..... or Company Order No.

Cheque/Postal Order No.

Barclaycard/Access No.

Name.

Address.

.....

Tel. No.

MEDIA MAIL ORDER

17 Crabtree Close, Beaconsfield, Bucks HP9 1UQ

Packaged **I**nformation **P**rocessing **S**ystems

We offer a variety of turnkey systems based on APPLE II and MICRO STAR.

It is our endeavour to give a complete service from problem determination through
 to the supply of computer based solutions. We will solve the problem either with a
 tailor made suit of programs, or a ready written package from another famous
 software house.

We can also supply three excellent DEVELOPMENT
 SYSTEMS, namely NASCOM, ACORN and NORTH
 STAR HORIZON



Phone for further details or...

Come along and see all of the above
 equipment, plus a wide range of
 peripherals, which are now on
 display in our new offices and
 showroom.

AT
 15 Sandhill, Quayside, Newcastle Upon Tyne
 Tel: 0632 614939



MICRO-COMPUTERS ARE



NO FURTHER
THAN THE ..

**BUSS
STOP**

**Petsoft
commodore**

8K PET new and standard types	£490.00
16K RAM and New Large Keyboard	£475.00
32K RAM and New Large Keyboard	£745.00
PET 3040 Dual Mini-floppy 343K	£745.00
PET 3022 80 col. dot matrix printer with tractor feed	£604.00
PET C2N External Cassette Deck	£ 51.00
KIM1 Micro system	£ 93.00
KIM3B Memory Expansion	£96.95
KIM4 Motherboard	£ 65.00

Phone for keenest O.E.M. and educational user prices.

VIDEO GENIE IN STOCK SOON

Tandy level II compatible ready to go home computer
only £356.00 Phone for more details.

NASCOM

Nascom-1 A KIT	£125.00
Nascom 1A BUILT	£140.00
Nascom 2 KIT	£295.00
Nascom IMP printer	£325.00

SOFTWARE

C12's Boxes of 10 ONLY	£ 4.50
Floppy Disks boxes of 10	£ 35.00

COMMODORE BUSINESS SOFTWARE PETSOFT
Bristol software factory ALL ON DEMONSTRATION.
If we can't find a package to suit you one can be
written or modified by our experts. Books and pro-
gramming aids available.

SERVICE & HIRE

REPAIRS — all done in our own workshops. Service contracts
are available. Hire PET 32K — £6.50 per day.

MAIL ORDER AND DELIVERY ARRANGED

Carriage — £15 on hardware other items £1. All prices + VAT

*Ring Rod for details and demonstration or
just call in at the BUSS STOP*

**255a St. Albans Road, Watford, Herts
(entrance in Judge Street)**

Phone: Watford 40698 or Newport Pagnell 610625

SORCERER'S APPRENTICE

Software for the Exidy Sorcerer

OVER 200 PROGRAMS NOW AVAILABLE!

— Everything from games to professional business packages —
— full listing on request —

PRINTERS RICOH RP-40 daisywheel £1450
OKI Microline 80 matrix £ 499

EXIDY PRODUCTS full range supplied

Please complete the form below and we will send you full
details completely free, and add your name to our mailing
list. (If you have previously written to us we will send you a
new list automatically.)

To: MICROPUTE, FREEPOST, MACCLESFIELD, CHESHIRE SK10 1YE

Please send details of:- I am interested in programs for:-

Cassette software.....	Personal use.....
Disc software.....	Business use.....
Exidy Products.....	Educational.....
Printers.....	Other.....

My present system comprises:- I have written programs on:-

NAME:
ADDRESS:

NO STAMP REQUIRED TO ABOVE ADDRESS, IF POSTED IN BRITISH ISLES

Philips Mini-Digital Cassette Recorder.

CASSETTE RECORDER

The Mini-Digital Cassette Recorder (Mini-DCR) can operate in the following modes: Idle, Read, Write, Backspace and Rewind. Complementing the quality and reliability of the Mini-Digital Cassette Recorder are Philips mini-cassettes certified for digital data recording applications. These mini-cassettes use tape which is certified for freedom from drop-outs. Mini-cassettes have been widely used for program loading in Philips office computers during the last four years, and over half a million are already in service. Low cost, low power consumption and compact size of the Mini-Digital Cassette Recorders mean they are ideal for program loading and updating applications as well as providing a highly convenient data capture facility.

Ample capacity for program loading and data interchange is provided by the 128 k byte capacity, and the high data transfer rate of 6000 bits/sec allows quick reading and writing of programs and data.

PRICES INCLUDING MANUAL
MINI D.C.R. £95 ea. + VAT
INTERFACE £37.50 ea. + VAT
INCLUDE £2.25 FOR CARRIAGE ETC.

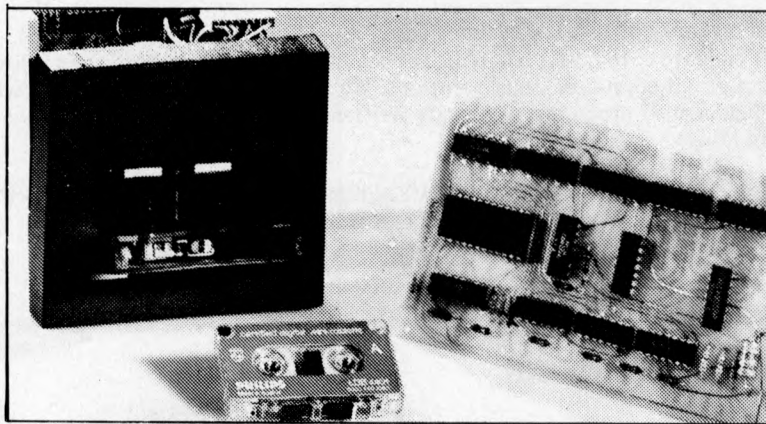

INTERFACE BOARD

This compact interface board was designed specifically for the purpose of interfacing the Philips Mini DCR to a Micro-computer. CMOS logic is used to keep power consumption very low, enabling it to be powered from the micro-computer that it is serving. Flexibility of the system was held as paramount, address decoding can be changed simply by moving links

By using subroutines held in the micro-computer to control the system the user can make his controlling program to suit his own particular needs and can be as simple or as complicated as necessary.

CURRAH

COMPUTER
COMPONENTS

79 Crowland Rd. Hartlepool Cleveland.
TS 24 2JN. Phone 0429 / 871900



SIRTON PRODUCTS

13 Warwick Road, Coulsdon, Surrey, CR3 2EF
Telephone : 01 - 660 5617

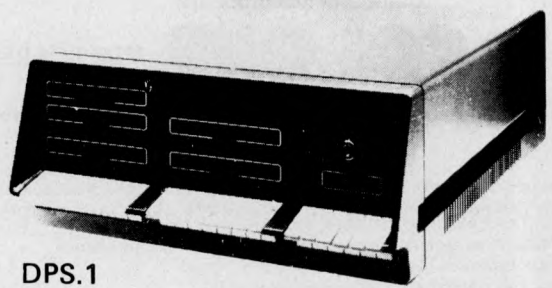

DPS.1

Professional versatile computer system with comprehensive front panel facilities and 20-slot motherboard. Units have substantial power supply etc. and come with 2 or 4 MHz Z80 CPU. BUS conforms to the IEEE S100 standard.

DPS.1 from £695

Available with K2 operating systems & PASCAL/Z. Companion Disc Drive Enclosure for on-line storage for 250K Bytes to 2 M Bytes.

MIDAS

MIDAS S.100 SYSTEMS

Substantial Mainframe to house your S100 system, with optional 5" or 8" disc drives. Special systems built to your requirements from Z80 CPU and other S100 boards held in stock

Mainframes from £228

MIDAS 1 : Z80 System from £625

MIDAS 2 : Z80 Disc System from £1100

MIDAS 3 : Z80 Disc System 8" from £1350

DOUBLE DENSITY recording available on MIDAS giving up to 2M BYTES of on-line storage.

Software for MIDAS includes CP/M, FORTRAN, COBOL, PASCAL and several BASICS including XYBASIC for control applicaitons.

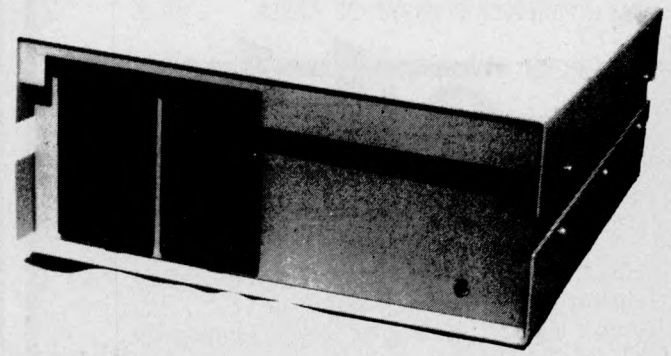

Board Kits — All available as built & tested boards

- Z80 Starter kit, featuring on-board Key-board, 2K Monitor, 1K RAM, 2x8 bit I/O Ports, Prom Programmer etc. etc. £188.00
- Z80 CPU, 2MHz, 1K RAM, up to 8K EPROM, S/P I/O Port, four-channel counter timer — SBC100 £159.00
- Z80 CPU, as above but 4MHz SBC200 £177.00
- Z80 CPU Board, 4 MHz, jump-on-Reset £116.00
- 8080 CPU Board, jump-on-reset £92.00
- 8K RAM Board, low power 450 n Sec (21L02) £79.00
- 16K RAM Board, low power 250 n Sec Static A/T £195.00
- 32K RAM Board, extended addressing, Static £343.00
- Memory Manager, allows memory expansion addressing to 16M Bytes — IEEE spec £39.00
- Dynamic RAM Board, 2 MHz, 16-64K £129.00
- Dynamic RAM Board, 4 MHz, 16-64k, A/T from £167.00
- 2708 EPROM (16k) Board £60.00
- 2708/2716 EPROM Prog Board, 2 Textool Sockets £90.00
- PROM 100 Programmer Board £110.00
- I/O Board, 2S/2P, with DIP switch selection £100.00
- I/O Board, 2S/4P, provision 4K RAM/4K ROM £135.00
- I/O Board, 2S/4P, with interrupts A/T £210.00
- Analogue I/O Board, 8 ch 8/10 Bit A/T £295.00
- Analogue I/O Board, 2 ch 12 bit A/D, 2 ch D/A £287.00
- Video Interface, 16 lines, 32 or 64 ch/line (60 frames) £93.00
- Video Interface, 16 lines, 64 ch/line (1/0 Port driven) £99.00

- Video Interface, IEEE spec, 80 ch by 24 1, memory mapped up to 256 ch, 50Hz, £230.00
- Video Display, 24 1, 80 ch/1, keyboard interface, 2K RAM, special characters available etc £198.00
- Video Interface, 16 lines, 64 characters (50 frames) £104.00
- High Density Graphics from Vector, inc 8K RAM Board A/T £333.00
- Real Time Clock Board from Mountain Hardware A/T £140.00
- Motherboard (9 slot with 4 edge connectors) £35.00
- Motherboard (13 slot with 4 edge connectors) £43.00
- Extender Board with logic probe for voltage level impulses £29.00

FLOPPY DISCS
Disc Controller, 5" or 8" £139.00

- Software**
- CP/M on 8" or 5" £75.00
 - CP/M 2 £106.00
 - C-BASIC 2 £75.00
 - Microsoft BASIC V.5 £155.00
 - XYBASIC Extended £215.00
 - Microsoft FORTRAN 80 £205.00
 - Microsoft COBOL 80 £325.00
 - PASCAL/Z CP/M Version £165.00
 - PASCAL (UCSD) £150.00
 - MAC Macro-Assembler 8080 with Z80 Library £55.00
 - Z80 Ass, Linker & Editor £56.00
 - ZS1D Trace & Debug Tool £50.00
 - Diszilog Disassembler £35.00
 - Wordstar Text Editor £255.00
 - Supersort £125.00

Mainframes from £239
MIDAS 1: Z80 System from £680
MIDAS 2: Z80 Disk System 5" from £1259
MIDAS 3: Z80 Disc System 8" from £1535

WRITE OR PHONE FOR CATALOGUE NEW SHOWROOM AT 76 GODSTONE RD, KENLEY (Nr. CROYDON)

apple

PAPER TIGER WITH GRAPHICS	£708.00
APPLE II EUROPLUS 16K	£695.00
DISC DRIVE WITH CONTROLLER	£349.00
DISC DRIVE WITHOUT CONTROLLER	£299.00
16K ADD ON MEMORY	£ 69.00
HITACHI 9" BLACK & WHITE MONITOR	£127.00
EUROCOLOUR CARD	£ 69.00
PASCAL LANGUAGE CARD	£296.00
ALF MUSIC SYNTHESISER CARD	£215.00
TCM 100 SILENT 40 COLUMN PRINTER	£243.00
TCM 100 SILENT 80 COLUMN PRINTER	£395.00
TCM INTERFACE FOR PET OR APPLE	£ 49.00

FROM

adda

Adda Computers, 17-19 The Broadway, Ealing,
London W.5. Tel: 01-579 5845
Abbott House, 1-2 Hanover Street, London W1.
Tel: 01-408 1611
Open 09.00-18.00 Monday to Friday. 10.00-16.00 Saturdays.

hi-tech electronics

1 Richmond Gardens, Highfield Southampton SO2 1RY
Telephone (0703)555072

OUR S 100 **COLOUR** VDU BOARD

WILL MAKE YOUR FRIENDS GREEN WITH ENVY AND OUR COMPETITORS SEE RED AND ANY OTHER OF OUR SPLENDID RANGE OF COLOURS

- HIGH DEFINITION, FULLY INTERLACED 625 LINE PAL COLOUR VDU BOARD
- 20 COLOURS AND GREY-SCALE TONES, INCLUDING RED, GREEN, BLUE, YELLOW, MAGENTA, CYAN, BROWN, PURPLE, ETC.
- 24 LINES OF 40 CHARACTERS, MIXED GRAPHIC AND ALPHANUMERIC
- COLOUR GRAPHICS RESOLUTION OF 80x72
- UPPER AND LOWER-CASE, DEFINITION OF 10x14
- ALL CHARACTERS CAN FLASH AND HAVE ANY HUE
- SEPARATE BACKGROUND AND FOREGROUND COLOURS
- 256 DIFFERENT GRAPHIC CHARACTERS
- SELECTABLE DOUBLE-HEIGHT CHARACTERS AND TWO PAGE MEMORY
- 1K MEMORY, MAPPED TO ANY 2K BOUNDARY
- 64 PORT - PROGRAMMABLE INSTRUCTIONS
- MONITOR, OR UHF OUTPUTS, RGB TO ORDER
- TELETEXT AND PRESTEL COMPATIBLE CHARACTER SET
- BRITISH DESIGNED AND MADE

NOW AVAILABLE

- PROGRAMMABLE 13A MAINS DISTRIBUTION BOX, FULLY ISOLATED, FITS TTL 8 BIT LATCHED PARALLEL OUTPUT PORT FROM YOUR COMPUTER, AND CONTROLS 3 ON/OFF AND 1 32-LEVEL DIMMER SOCKETS **£69.00**
- S100 COLOUR VDU BOARD, UHF OUTPUT **£215.05**
- S100 COLOUR VDU BOARD, MONITOR OUTPUT **£215.05**
- S100 16K MEMORY BOARD, 250 nS **£210.95**

PRICES INCLUDE P&P - BUT NOT 15% VAT

COMING SOON:

- S100 TELETEXT TUNER/DECODER, S100 MUSIC SYNTHESISER, ETC.

WE OFFER A COMPLETE SERVICE!

When you buy a computer from us — we don't give you the box and wave goodbye.

We realise this is a major purchase for a Company and take the time to find out your requirements, design your computer system and write the software, or if you prefer to write your own, we will always be available to advise you.

You can buy a wide range of fully-documented packages — Word Processing/Purchase & Sales Ledgers/ Stock Control/Incomplete Records/Medical Systems/Teaching Programs etc. on Microcomputers such as—

APPLE II from £750
(16K)
A complete business system 48K
Apple, 2 Disk Drives, VDU &
Printer £2,500

MICROSTAR from
£4,950
Multi-user/Multi-task
1.2/2.4 or 4.8 mb.
A complete system with 2 VDUs
& Printer £7,000

ALPHA MICRO from
£9,950
From 1 to 32 terminals.
From 10 mb. to 90 mb. disk
storage.
16-bit processor, Multi-user
operating system.

**We stock a full range of VDUs, Printers,
Computer Stationery, Diskettes, Disk Boxes etc.**

all prices ex VAT.

Come and see us to discuss your requirements and have a demonstration.

MICROSOLVE

Microsolve Computer Services Ltd
3rd Floor, Middlesex House, High Street,
Edgware, Middlesex.
M1 junction 4 /20 mins from Central London.

e.g.
**LOW COST
PRINTERM**
matrix printer £695
LEAR SEIGLER
200A matrix printer £1,650
QUME Sprint 5
daisywheel printer £2,115.

ADVERTISERS INDEX

Abacus	83	Currah	128	Intelligent Artefacts	78	PIPS	127
Acorn Computers	119	DAMS	24	Interactive Data	125	Portable Microsystems	3
ACT	70,71	Datron Microcentre	2	Systems	98	Pyral Magnetics	122
Aculab	24	Direct Data Marketing	8	Interface	124	Q-Com Electronics	120
Adda	130	Display Electronics	118	Intex Datalog	31	Research Machines	117
Almarc Data Systems	12,110	Distributed Data	39	Kingston Computers	10	Rohan Computing	12
APT	6	Processing	50	A&G Knight	4,5	Mike Rose Micros	112
Benchmark	78	Dynabyte (UK & Europe)	22	Lifeboat Associates	23	Rostronics	13
BNR&ES	125	Electronic Brokers	78	Lion Microcomputers	124	Science of Cambridge	18,19
Business & Leisure		Engineering Graphic	113	Little Genius	21	Simon Computers	120
Microcomputers	78	Applications	27,66	Liveport Data Products	122	Sintrom Microshop	123
Buss Stop	128	Ensign	20	L&J Computers	25	Sirton Products	129
Camden Electronics	114	Equinox	20	Logitek	17	Small Systems	
Carter Keyboards	114	Farmplan	20	Low Electronics	22	Engineering	55,116
CCS Microhire/		Feldon Audio	20	LP Enterprises	22	Stack	29
Microsales	131	Gata Microsystems	82	Media Mail Order	127	Strumtech (SEED)	11,49
Comart	9,80	Gemsoft	122	Microcentre	IFC	Tangerine	30
Commodore	35	GW Computers	28	Microdigital	8	Tempus	126
Comp Shop	132,IBC	Happy Memories	124	Micropute	128	Transam Components	92
Computerama	111	A J Harding	26	Microsolve	130	TVJ Microcomputers	14,15
Computer Centre	64	(Molimerx)	120	Newbear	110,121	X Data	7
Computerist/Dair	67	HB Computers	114	On-line Conferences	16	Xitan Systems	115
Computermania	24	Henry's	130	PHL	67	Zenith Data	36
Computopia	125	Hitech Electronics	127	Personal Computers	OBC		
CRA	126	Home & Business		Petalect	126		
Cumana	58	Computers		Petsoft	84		

COMPLETE COMPUTER SYSTEMS (CCS)

PRESENT
the **ABC80**

Zilog Z80A microprocessor, the ABC 80's brain.

Professional keyboard of Swedish standard.

12" black-and-white TV screen. Displays capitals and small letters, digits, figures and diagrams. Room for 24 lines of 40 characters each.

Built-in graphic mode. Uses 64 different graphic symbols.
Program memory. 16 K BASIC of ROM, 16K bytes of RAM. 2K Monitor in ROM. 1K Picture RAM.
Loudspeaker. 128 different sound effects. Can be used to provide alarms or other signals.

Cassette memory for storing programs and data. Fast winding in both directions.

Built-in real-time clock for timing.
price £790.00 (optionally).
Available from U.K. Importers



V-24 jack for connecting to a telephone modem so that you can communicate with other computer systems via the public telephone network.

46/80 Bus for connecting peripherals such as floppy-disk units, printers, plotters, measuring instruments etc.



The Leading Microcomputer Hire Company with the best range of equipment:

PET (8K) now £3.70/day*
APPLE (16K) now £5.20/day*
ABC 80; PET; Exidy Sorcerer; SEED System One/MSI 6800; NASCOM/MICROS; Research Machines 380Z and Tandy TRS-80

Over 500 million Bytes (half megabytes memory) available for hire in units from 4K to 48K.

Send for our NEW PRICE LIST giving the most attractive prices yet.

* four day rates

C.C.S. MICROSALES & C.C.S. MICROHIRE
7 THE ARCADE,
LETCWORTH
HERTS SG2 4YA.

Tel: Letchworth (04626) 73301

I would like to come and see the ABC80, PET, APPLE
Please call me back to arrange an appointment.
NAME.....
Company.....
Location.....
Tel..... Ext.....

8MHz Super Quality Modulators	£4.90
6MHz Standard Modulators	£2.90
C12 Computer Grade Cassettes 10 for	£4.00
Super Multi-rail P.S.U. +5 -5 +12v	£29.50
Nascom I with Nas-sys Kit	Special Price
Assembled } Limited quantities	£125.00
	£140.00
ETI Breakout Game - Chip and PCB	£9.90
S100 Expansion Motherboard for Nascom I	£39.00
Anadex Printer Paper - 2000 sheets	£25.00
Floppy Disks 5¼" Hard & Soft Sector	£3.50
Floppy Disk Library Case 5¼"	£3.50
Lexicon Language Translator	£125.00
Modules for Lexicon	£29.00
Eprom Boards	£63.00
8K Static Ram Boards - S100	£110.00
Grandstand Video Game	£59.00
Cartridges for Grandstand	£11.99
George Risk Ascii Keyboard	£39.00
Cartridges for Atari - Full Range in Stock	£13.90
Interface PET IEEE - Centronics Parallel Not decoded	£49.00
Decoded	£77.00
Interface to Centronics parallel for TRS80	£75.00
Verocases for Nascom 1 & 2 etc.	£22.50
Keyboard Cases	£9.90
Electric Pencil for TRS80	£29.00

only **£399** + VAT



TRS80 LEVEL 2 16K

Fully converted to UK T.V. Standard. Comes complete with easy to follow manuals. UK Power Supply - Cassette Leads - Sample tapes. Special box to enable you to plug into your own TV. Recommended for first time-buyers. Just plug in and go. Full Range of Software Available

only **£295** + VAT

32K TRS80 EXPANSION INTERFACE



Expand your TRS80 by 32K. 32K Memory on board. Centronics parallel port. Disk controller card. Real time clock. Requires Level II Basic. Interface for 2 cassette decks. complete with power supply.

RRP £540 only **£499** + VAT

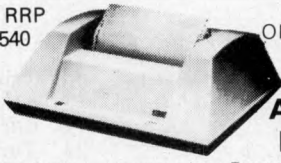

ANADEX DP8000

Super Quality - Low cost printer. Tractor Feed with full 96 ASCII character set. Accepts RS232C at band rates between 100 and 9600 and Parallel Bit data. Attaches either directly or through interfaces to Pet, Apple, TRS80, Sorcerer, Nascom, CompuKit etc.

NEW REDUCED PRICES

8K **£449** } + VAT
 16K **£549** }
 32K **£649** }



The PEDIGREE PETS

RRP £795 for 32K

Very popular for home & business use. 8K Microsoft Basic in ROM. 8K Pet 32K & 16K with new improved keyboard. All with green screen. Extra cassette deck **£55** Full range of software available.

RRP £690 only **£590** + VAT



IBM SELECTRIC GOLFBALL

Refurbished IBM Golfball Printers to new specs. Accepts Centronics parallel data. Friction feed. Prints at 15 cps. Attaches either directly or through interfaces to Pet, Apple, TRS80, Sorcerer, Nascom, CompuKit etc.

32K **£690** + VAT

48K **£790** + VAT



EXIDY SORCERER

RRP £859 for 32K

For Personal or Business Use.
 32K or 48K memory. 8K Microsoft Basic in ROM. Dual Cassette I/O, RS232 I/O. Parallel I/O (Centronics). Expansion available through optional extra S100 Motherboard. 69 Key keyboard including 16 key numeric pad.

S100 EXPANSION - £199

video 100

12" BLACK & WHITE LOW COST VIDEO MONITOR

RRP £79 only **£69** + VAT



- Ideal for home, personal and business computer systems
- 12" diagonal video monitor
- Composite video input
- Composite video input
- Compatible with many computer systems
- Solid-state circuitry for a stable & sharp picture
- Video bandwidth - 12MHz + 3dB
- Input impedance -75 Ohms
- Resolution - 650 lines Minimum In Central 80% of CRT; 550 Lines Minimum beyond central 80%.

HITACHI PROFESSIONAL MONITORS

9" - **£129**
 12" - **£199**



- **Reliability** Solid state circuitry using an IC and silicon transistors ensures high reliability.
- **500 lines horizontal resolution** Horizontal resolution in excess of 500 lines is achieved in picture center.
- **Stable picture** Even played back pictures of VTR can be displayed without jittering.
- **Looping video input** Video input can be looped through with built-in termination switch.
- **External sync operation** (available as option for U and C types)
- **Compact construction** Two monitors are mountable side by side in a standard 19-inch rack.

RRP £975 for 48K

48K - **£690** + VAT



ITT 2020

Full colour into your own colour T.V. PALSOFT 9 digit floating point Basic in ROM as standard. Low and High resolution graphics. Built in loudspeaker. Compatible with most Apple Hardware add-ons and software.

NASCOM-2 MICRO-COMPUTER

only **£295** + VAT



FREE POWER SUPPLY

Microprocessors Z80A. 8 bit CPU. This will run at 4MHz but is selectable between 1/2/4 MHz. This CPU has now been generally accepted as the most powerful, 8 bit processor on the market.

INTERFACE New expanded 57 key Licon solid state keyboard especially built for Nascom. Uses standard Nascom, monitor controlled, decoding.

T.V. The Iv peak to peak video signal can drive a monitor directly and is also fed to the on-board modulator to drive the domestic T.V.

I.O. On-board UART (Int.6402) which provides serial handling for the on-board cassette interface or the RS232/20mA teletype interface. The cassette interface is Kansas City standard at either 300 or 1200 baud. This is a link option on the NASCOM-2. The RS232 and 20mA loop connector will interface directly into any standard teletype. The input and output sides of the UART are independently switchable between any of the options - i.e. it is possible to house input on the cassette and output on the printer.

PIO There is also a totally uncommitted Parallel I/O (MK3881) giving 16, programmable, I/O lines. These are addressable as 2 x 8 bit ports with complete handshake controls.

Documentation Full construction article is provided for those who buy a kit and an extensive software manual is provided for the monitor and Basic.

Basic The Nascom 2 contains a full 8K Microsoft Basic in one ROM chip with additional features like DEEK, DOKE, SET, RESET for simple programming. With free 16K RAM board.

A PROFESSIONAL WORD PROCESSING SYSTEM AND IT'S A COMPUTER AS WELL.

FOR ONLY **£3250** + VAT



PET 32K - This is the standard 32K Pet from Commodore. Reverse video and graphics allow the WordPro Package to give simple clear and easy to read displays.

2040 Disk Drives Twin disk drives allow large high speed storage for your letters, or paragraphs. Plugs in the back of the PET.

NEC Spinwriter NEC's high quality printer uses a print "thimble" that has less diameter and inertia than a daisy wheel, giving a quieter, faster, more reliable printer that can cope with plotting and printing (128 ASCII characters) with up to five copies, friction or tractor fed. The ribbon and thimble can be changed in seconds. 55 characters per second bidirectional printing - with red/black, bold, subscript, superscript, proportional spacing, tabbing, and much, much more.

WordPro II The heart of the system - consists of a ROM and diskette. The ROM is inserted into a space socket inside the Pet. One of the most versatile Word Processing Packages around.

COMPUKIT UK101

EUROPE'S FASTEST SELLING ONE BOARD COMPUTER



Simple Soldering due to clear and concise instructions compiled by **Dr. A.A. Berk, BSc. PhD.**

- ★ 6502 based system — best value for money on the market.
- ★ Powerful 8K Basic — Fastest around
- ★ Full Qwerty Keyboard
- ★ 4K RAM Expandable to 8K on board.
- ★ Power supply and RF Modulator on board.
- ★ No Extras needed — Plug-in and go.
- ★ Kansas City Tape Interface on board.
- ★ Free Sampler Tape including powerful Dissampler and Monitor with each Kit.
- ★ If you want to learn about Micros, but didn't know which machine to buy then **this is the machine for you.**

Build, Understand and Program your own Computer for only a small outlay.

KIT ONLY **£199 + VAT**
NO EXTRAS NEEDED

AVAILABLE READY ASSEMBLED & TESTED
READY TO GO FOR **£249 + VAT**

Specially designed case for CompuKit in orange/black. With room for accessories. **£29.50 + VAT**

6502 Assembler/Editor for CompuKit £14.90 + VAT

The **CompuKit UK101** comes in kit form with all the parts necessary to be up and working, supplied. No extras are needed. After plugging in just press the reset keys and the whole world of computing is at your fingertips. Should you wish to work in the machine code of the 6502 then just press the M key and the machine will be ready to execute your commands and programs. By pressing the C key the world of Basic is open to you.

This machine is ideal to the computing student or Maths student, ideal to teach your children arithmetic, and is also great fun to use.

Because of the enormous volume of users of this kit we are able to offer a **new reduced price of £199 + VAT**

THE NEW TRS80 SURPRISE — MODEL II

Fast and expandable!

Model II operates at twice TRS-80's high speed.



In addition to either 32 or 64 thousand characters (bytes) of internal Random Access Memory, one built-in 8" floppy disk stores an additional one-half million bytes, including the Disk Operating System. And you can easily expand up to a four-disk system for up to two-million bytes of storage.

Model II features upper and lower case letters. Its built-in 12" high-resolution video monitor displays 24 lines of 80 normal characters. The professional 76-key keyboard (with "calculator" keypad) includes advanced functions such as Control, Escape, Caps, Hold, Repeat. The keyboard is detachable and moveable for convenient data entry.

You get the enhanced Level III version of TRS-80's already-famous Level II BASIC language and "TRSDOS" operating system, automatically loaded in memory when you "power up." (About 24K of RAM is used by this software.)

Each time you power up, Model II thoroughly tests itself to insure proper operation. Your chosen program can appear immediately, without any intermediate steps or questions to answer.

Versatility ... plug-in expandability

Built-in input/output capabilities include two RS-232C channels, and one Centronics parallel port. Future expansion is provided for through four plug-in slots for optional PC boards.

32K 1-Disk Model II
£1999.00 + VAT

64K 1-Disk Model II
£2200.00 + VAT

3 DISK EXPANSION

500K per Drive gives total of 1.5M Byte for only **£1399 + VAT**

Just Plug In

WE ARE NOW EX-STOCK



Why do people buy more from COMPSHOP than anywhere else?

- ★ **LARGER STOCKS** — we hardly ever run out
- ★ **GOOD SERVICE** — we give extended warranties on all our products.
- ★ **EXCELLENT REPAIR SERVICE** — Through CompuCare we repair and maintain most makes of personal computers.

LAST YEAR WE SUPPLIED TO THE PUBLIC — LARGE & SMALL
16,000 Television Games & 7,000 Computer Systems



CompuCare is a company that has been set up to provide servicing and maintenance for the popular makes of micro-computers i.e. Sorcerer, Pet, Apple, TRS80, Nascom, CompuKit. Our charges are £7 per hour plus parts.

Because of the extensive range of spare parts stocked you can usually expect your micro to be repaired within 10 days for an average charge of £14 labour.

Emergency 24 hour repairs can be handled for a £10 surcharge where possible. CompuKits and Nascoms unsuccessfully constructed will be charged a standard £25.

THE ATARI VIDEO COMPUTER SYSTEM

£138 + VAT



Atari's Video Computer System now offers more than 1300 different game variations and options in twenty great Game Program™ cartridges!

Have fun while you sharpen your mental and physical coordination. You can play rousing, challenging, sophisticated video games, the games that made Atari famous. You'll have thrill after thrill, whether you're in the thick of a dogfight, screeching around a racetrack, or dodging asteroids in an alien galaxy. With crisp bright colour (on colour TV) and incredible, true-to-life sound effects. With special circuits to protect your TV.

Cartridges now available All at **£13.90** each + VAT

Basic Maths, Airsea Battle, Black Jack, Breakout, Surround, Spacewar, Video Olympics, Outlaw, Basketball, Hunt & Score*, Space War, Sky Diver, Air Sea Battle Codebreaker*, Miniature Golf.

Extra Paddle Controllers
— **£14.90 + VAT**

*Keyboard Controllers
— **£16.90 + VAT**



Please add VAT to all prices — Delivery at cost, will be advised at time of purchase. Please make cheques and postal orders payable to COMPSHOP LTD., or phone your order quoting BARCLAYCARD, ACCESS, DINERS CLUB or AMERICAN EXPRESS number.

CREDIT FACILITIES ARRANGED — send S.A.E. for application form.

14 Station Road, New Barnet, Hertfordshire, EN5 1QW Telex: 298755 TELCOM G

Telephone: 01-441 2922 (Sales) 01-449 6596

OPEN - 10 am - 7 pm — Monday to Saturday

★ NOW OPEN ALL DAY SUNDAY — For Shop Sales Only ★
Close to New Barnet BR Station — Moorgate Line.



COMP COMPUTER COMPONENTS
(Part of the Compsnop Ltd. Group)



"My best Apple programs are on long-term deposit in the City... it pays rather well!"

We brought the first five Apples into the U.K. in November '77, with every penny we had. In November '79, we find several thousand throughout the country.

THANK YOU Apple owners.

Now we'd like to help you re-coup your investment by cataloguing and supporting the best Apple programs in the U.K. The Apple Software Bank is more like an old penny bank than a major clearing bank, but we know you'll help it grow. Telephone Stephen Derrick on 01-626-8121 to discuss your investment.

ATTENTION ALL Estate Agents, Employment Agencies, Yacht Brokers, Antique Dealers and Motor Traders.

Find out about *FINDER SOFTWARE!*

SOME BLUE CHIPS

TESKIM. This ROM will simulate the Tektronix 4010 family of graphics terminals. It's rather good!

UPPER LOWER CASE ADAPTOR A chip for the chap considering word processing.

NEW ISSUES

We are continually trying to bring the latest add-ons for your Apples. Please phone for the latest product information and data sheets.

NEW PRODUCTS

8" *SHUGART DISKS* giving 1.2 Megabytes A twin drive (with room for a third.) disk system with controller and software, give tremendous commercial possibilities. £2350 Excl. V.A.T.

WORD PROCESSOR. Ask about our Apple II Plus word processor package. Complete System with Diablo 1650 Daisy-Wheel Printer. £4250 Excl. V.A.T.

PERSONAL COMPUTER PRINTERS. Sensational 40 & 80 Character printer (graphics options) from £243 Excl. V.A.T. Interfaces for Apple, Pet & TRS 80. High quality silent printers. It's your choice!

A/D BOARD At last we have either an 8 bit or 12 bit A/D card for Apple. Excellent spec from £125 Excl. V.A.T.

APPLE PASCAL £296



Personal Computers Limited

194-200 Bishopsgate, London EC2M 4NR.

Let us advise you about *COLOUR DISPLAY* on your Apple.
Contact Technical Services.

